

LOW VOLTAGE AC DRIVES

ABB drives for water and wastewater

ACQ580, 0.75 to 500 kW



ACQ580 series

Always flowing. Never still.

Water utilities require reliable solutions securing the flow of water and wastewater.

The ACQ580 drive for water is part of ABB's all-compatible drives portfolio. This robust drive is designed to secure optimal operation of water and wastewater pumps, while ensuring low energy consumption.

Contents

4-11	The energy efficient drive for water and wastewater pumping
6-7	All-compatible solutions for water and wastewater applications
8-9	Optimizing the flow of water and wastewater in your pumping solutions
10	Built-in pump application software
11	General software features of the drive
12-19	How to select a drive
13	Technical specification
14	Securing the flow of water and wastewater with the ACQ580
15	Complete offering from wall-mounted drives to cabinet installations
16-18	Ratings, types and voltages
19	Dimensions
20-33	Options
20	Comprehensive connectivity
21	Hand-Off-Auto control panel
22	Effortless drive commissioning and use with control panels
23	Save time, ease troubleshooting and improve drive performance with ABB smartphone apps
24	High protection for operation in harsh environments
25	Quick configuration for unpowered drives
26	Flexible connectivity to automation
27	Thermistor protection modules for increased safety
28	Main disconnect switch for increased safety
29	EMC – electromagnetic compatibility
30-31	du/dt filters
32-33	Cooling and fuses
34-39	Motors control and automation products
34	Choose the motor for your water application
35	Ultimate efficiency and reliability to minimize your system cost of ownership
36	ABB automation products
37	Securing the flow of water and wastewater in the pump system
38-39	Services to match your needs
40	A lifetime of peak performance

The energy efficient drive for water and wastewater pumping

Whether your pump system requires redundancy in multi-pump applications or built-in pump application functionalities designed for the water and wastewater industry, the ACQ580 is designed to meet your requirements.



Simplicity at your fingertips

The control panel's straightforward primary settings menu with assistants helps you set up the drive quickly and effectively. See more on pages 21-22.

Speaks water-specific terminology

The drive has built-in pump application control programs to secure optimal operation of the water and wastewater pumps. See more on page 11.

Boosting energy efficiency

The energy optimizer helps you to save energy, and the energy efficiency information made available to you help monitor and save the energy used in your processes. The drive meets IE2 energy efficiency requirements. See more on page 11.



Reliable, integrated safety

Safe torque off (STO) built-in as standard and the ATEX certified thermistor protection module CPTC-02 provides enhanced process safety and easy, simplified installation. See more on pages 27-28.



Remote monitoring solutions

Remote monitoring via standard web browsers will help lower costs by reducing the amount of routine site visits. See more on page 25.



The ACQ580 water and wastewater drives are part of ABB's all-compatible drives portfolio. The drives secure the flow of water and wastewater in the pumping system throughout their whole life cycle. The ACQ580 drive is easy to commission and use. With built-in pump functionalities, the drive keeps the pumping system operating optimally, lowering the energy bill. The drive is used in water and wastewater treatment plants, pumping stations, desalination plants, industrial wastewater facilities and irrigation environments. The drive is used with inflow pumps, transfer pumps, dosing pumps, sludge pumps, booster pumps, submersible pumps and compressors, blowers, decanter centrifuges, mixers and fans.



Controls virtually any kind of motor

The drive has the ability to control almost any motors from induction and permanent magnet motors to synchronous reluctance motors. See more on pages 34-37.



Startup and maintenance tool

Drive composer PC tool for startup, configuration, monitoring and process tuning. The PC tool is connected to the drive's control panel with a standard USB cable. See more on page 25.

Robust with built-in features

A robust performer with enclosure class up to IP55, that is simple to select, and easy to install and use. Built-in features such as an EMC filter, choke, a Modbus RTU fieldbus interface and safe torque off (STO) functionality simplify drive selection, installation and use. See more on pages 24, 31.



Reliable communication

With its wide range of optional fieldbus adapters and embedded RTU Modbus, the drive enables connectivity with all major automation networks and control systems. See more on page 26.



Input/output extensions

In addition to the standard interfaces, the drive has a built-in slot for additional input/output extension modules. See more on page 26.

All-compatible solutions for water and wastewater applications

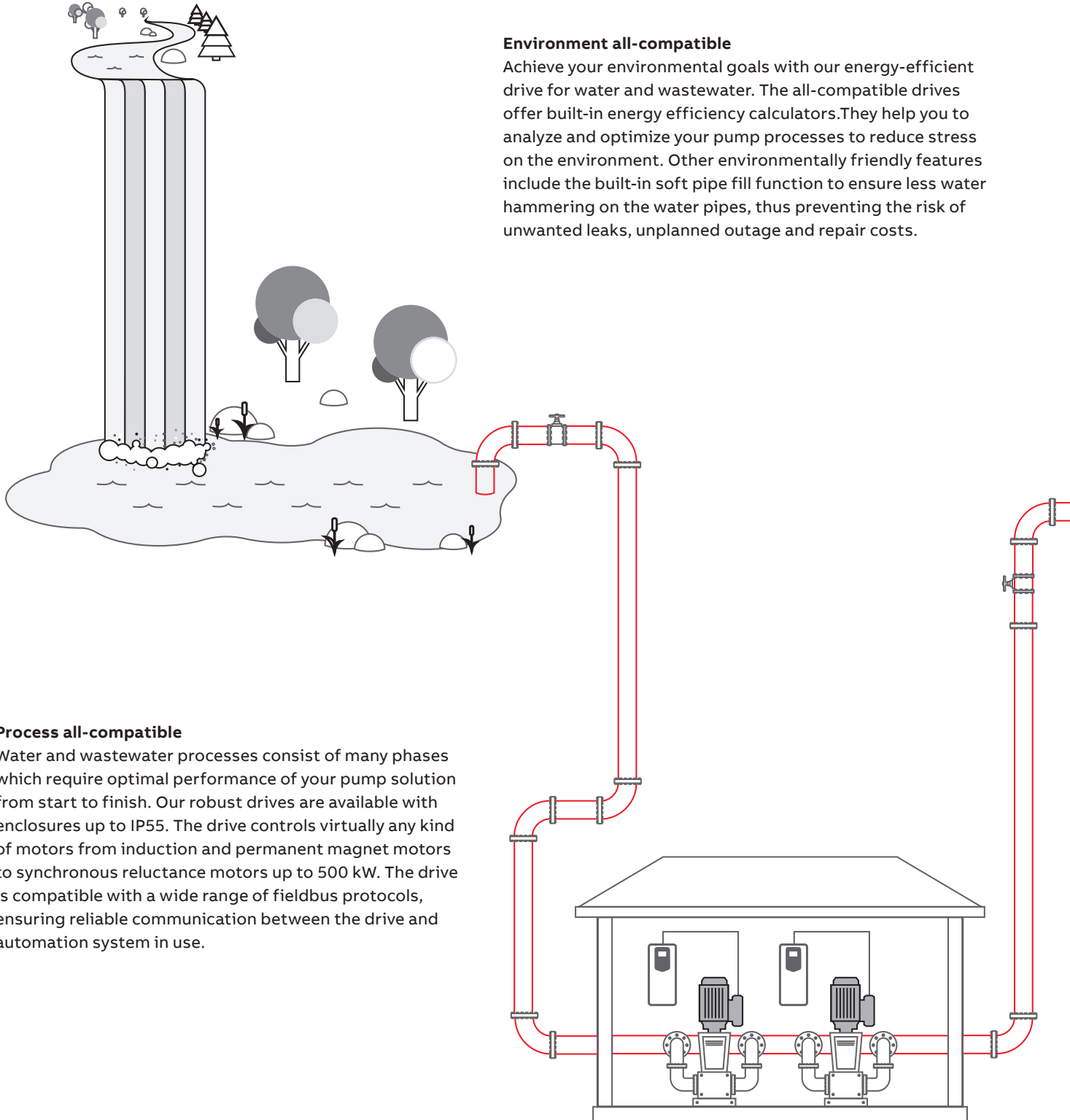

Environment all-compatible

Achieve your environmental goals with our energy-efficient drive for water and wastewater. The all-compatible drives offer built-in energy efficiency calculators. They help you to analyze and optimize your pump processes to reduce stress on the environment. Other environmentally friendly features include the built-in soft pipe fill function to ensure less water hammering on the water pipes, thus preventing the risk of unwanted leaks, unplanned outage and repair costs.

Process all-compatible

Water and wastewater processes consist of many phases which require optimal performance of your pump solution from start to finish. Our robust drives are available with enclosures up to IP55. The drive controls virtually any kind of motors from induction and permanent magnet motors to synchronous reluctance motors up to 500 kW. The drive is compatible with a wide range of fieldbus protocols, ensuring reliable communication between the drive and automation system in use.

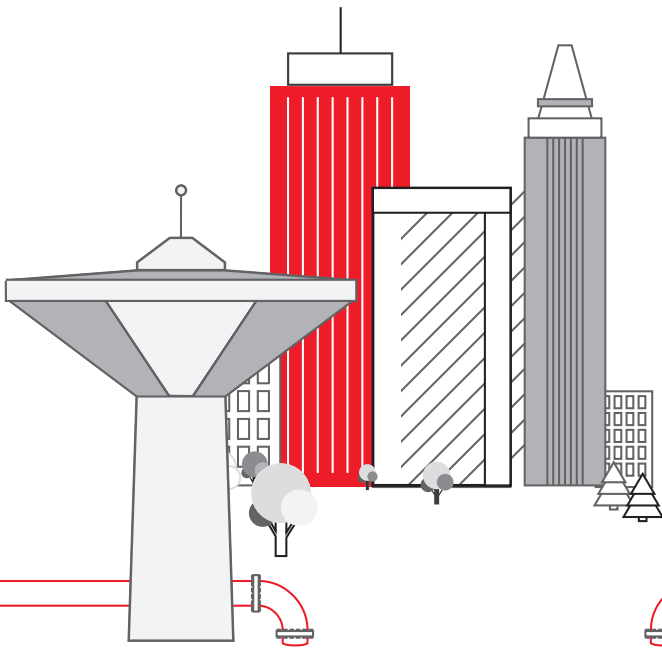

Business all-compatible

As a reliable global partner, we provide water process solutions that help to keep the life cycle costs of your pump solution stable. Additionally, we help keep your water process productive and consistent in an energy efficient way. Our wide range of water industry products and solutions offer optimal flow of water all hours of the day. This means lower energy consumption, improved productivity, flexibility and ease of use. With offices in over 90 countries and a global technical partner network, we offer technical advice and local support worldwide.

Human all-compatible

You can feel confident using our all-compatible drives for water and wastewater. The drive speaks the language of your pump application, making it easy to set up, configure and use. The intuitive Hand-Off-Auto control panel ensures that you have access to the essential information quickly. For accessing your drive from a distance and receiving valuable analytics, we offer remote monitoring solutions.

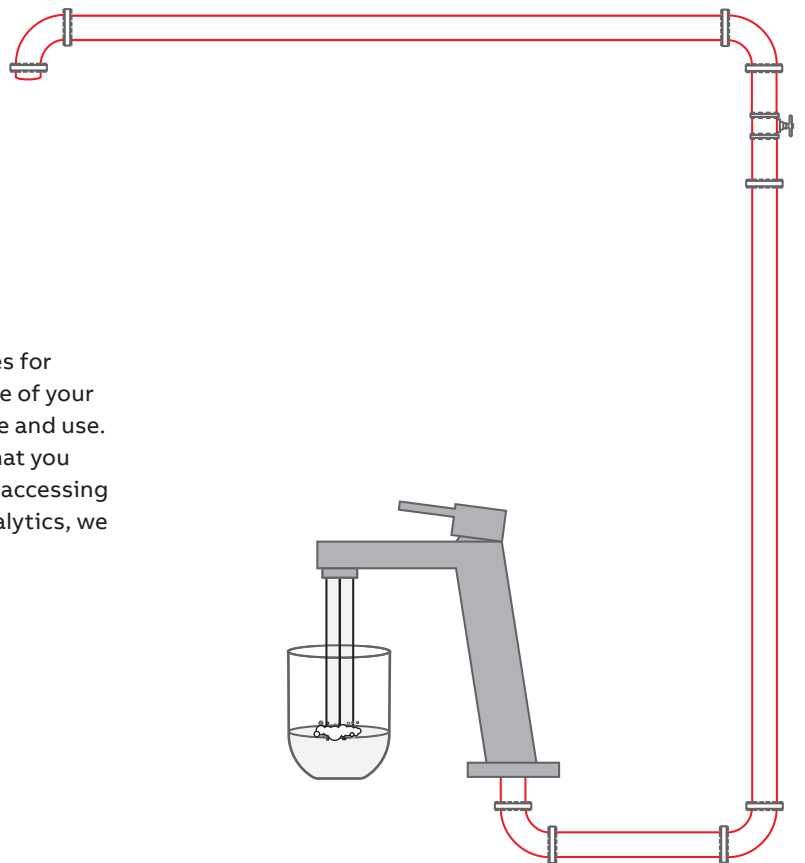

Optimizing the flow of water and wastewater in your pumping solutions

The ACQ580 water and wastewater drive is built to help users, designers, OEMs, system integrators and EPC professionals secure pumping of water and wastewater in municipal utilities, pumping stations, industrial wastewater facilities, desalination plants and irrigation environments. It offers long-term, technically-compatible drive solutions supported by full service and support.

Soft pipe filling

Increase the lifetime of the piping and pump system by avoiding pressure peaks.

Quick ramps

Extend the lifecycle of a submersible pumps by reducing wear of the mechanical parts using ramp sets to accelerate and decelerate the pumps.

Pump priority

Achieve energy savings with optimal pump alternation by running the higher capacity pumps when the consumption rate is higher.

Multi-pump control

Ensure stable and uninterrupted production with multi-pump controls by optimizing the speed and number of running pumps.



• **Sleep boost**

Save energy while extending the life time of the pumps and motors by decreasing start/stop cycles during all hours of the day.

• **Auto-change**

Increase the mean time between repairs and save in service costs by balancing the long-term operation time of all pumps in a parallel pumping system.

• **Level control**

Ensures optimal efficiency when filling or emptying a tank.

• **Sensorless flow calculation**

Reduce costs by eliminating the need for external components or backup the flow meters to avoid interruptions in the process.

• **Flow and pressure protection**

The drive protects the pumping system from a low and / or high pressure and flow, as well as prevents the pump from running dry.

• **Pump cleaning**

Achieve savings by preventing unplanned downtime. This is made possible as a result of accumulating obstructions being removed from the impeller of the pump.

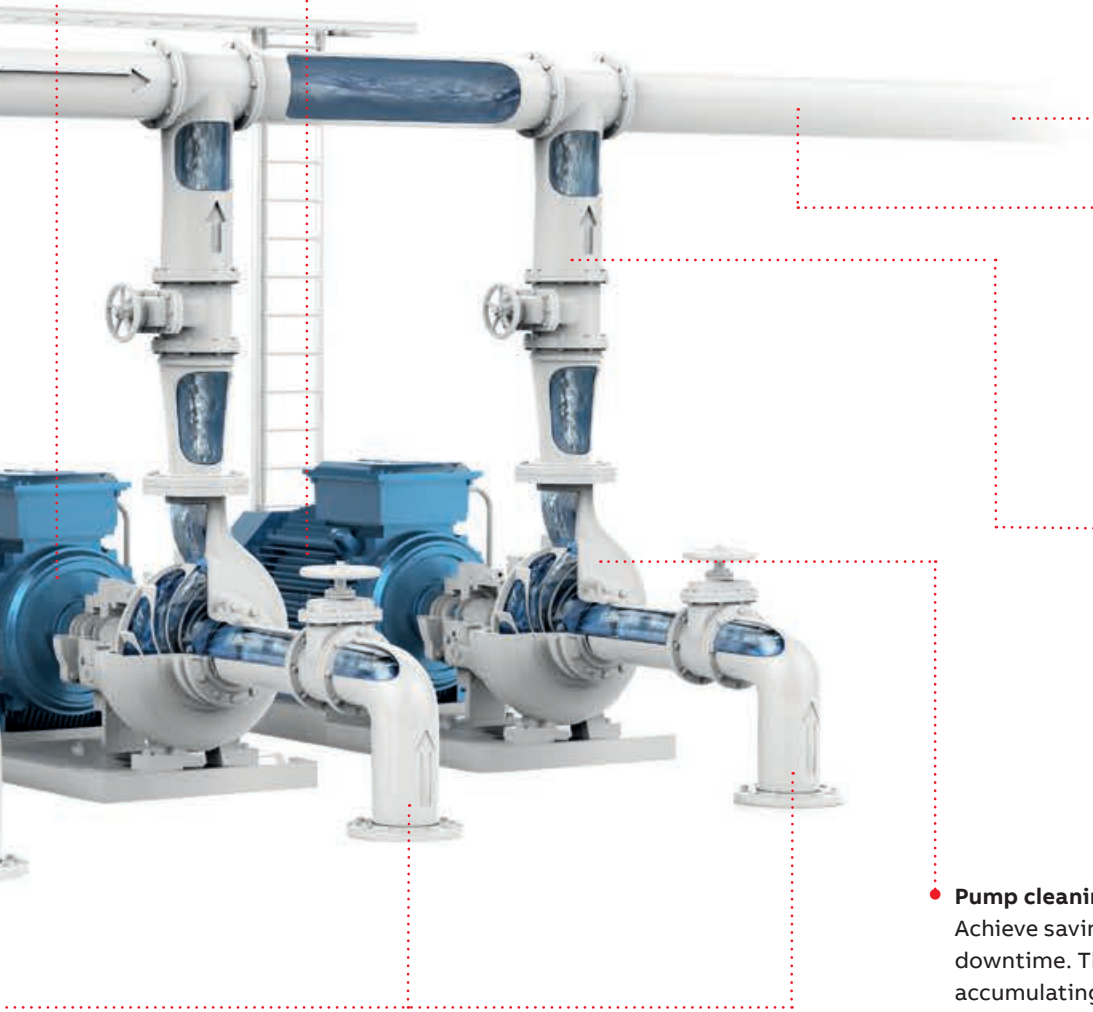

Built-in pump application software

The built-in pump application software in the ACQ580 drives is designed to enhance the reliability and durability of the water and wastewater application in which it is used. The functions protect the pump and secure its optimal functionality, increasing cost efficiency. The built-in functionalities also support the user in securing the flow of the water and wastewater in the pump solution.

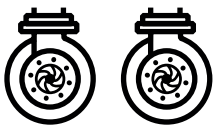

Multi-pump functionality

The function maintains stable process conditions for several parallel pumps (up to 8 pumps at the same time)

operating together. It is possible to optimize the speed and number of pumps needed when the required flow or pressure rate is variable. This built-in functionality ensures continuous operation for multipump systems even if one or more pumps fails or requires maintenance.



Sensorless flow calculation

Measures the amount of water flowing without the need for external sensors. This will enable you to reduce costs as there is no need for setting up and using additional sensors or back up the flow meters to avoid interruptions in the process.



Level control

Control the filling or emptying of wastewater storage and water tower tanks. Level control can be used within a station controlling up to eight pumps. The level control function has varying pre-set water levels and the pumps will start and stop based on measured level. This method allows the pumps to run at an efficient speed and ensures the pump sump does not become over contaminated by sediment.



Soft pipe fill

The soft pipe fill function manages the pressure of water by filling the pipeline with a gentle approach. This helps to avoid sudden pressure peaks and reduces the risk of water hammer which can cause damage to the water pipes.



Quick-ramp

Protect bearings when a submersible pump is started without water. Quick ramp allows your pump to reach optimal speed to extend pump life, ensure operation and prevent unplanned outages.

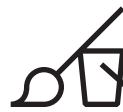

Pump cleaning

Keeps the impeller of the pump clean by running a sequence of aggressive ramps between minimum and maximum pump speed.



Turbidity reduction

When a pump starts as slow as possible, it creates the lowest turbidity values for the water being moved or extracted. When you combine quick ramps and long normal ramps, the drive will protect and run submersible pump most optimal way.



Pump protection

The built-in protection functionalities ensures that pumps can operate at the best possible conditions. The maximum pressure protections help to protect the pump and the system in case of a blockage in the pipeline. In case of a pipe rupture, the minimum pressure protection can generate an alarm or fault or can be programmed to run at certain speed to avoid dirty water entering the pipeline. The inlet pressure protection can help to avoid cavitation. When the inlet pressure of a water pump falls below pump design specifications, tiny vapor bubbles form. These bubbles collapse when they meet the impeller, causing shock waves and points of high temperature that can corrode the surface of the impeller.



Dry run protection

This function prevents the pump from running dry. The water pump shaft and impeller are rotating at fast rates. If there is no dry pump protection, the released heat can damage the pump over time, limiting its lifetime.

General software features of the drive

With a pump control software one drive controls several pumps or blowers in parallel and eliminates the need for an external programmable logic controller. This results in reduced stress on the mains and the system as well as in lower maintenance and operation costs.

Startup assistant allows first-time users to quickly customize the drive, out of the box, according to their needs. This is complemented by a built-in help function to make parameter-by-parameter setting easy.

Enjoy sophisticated process control in scalar and vector control modes. They support a wide range of motors including induction, permanent magnet and synchronous reluctance motors.

The energy optimizer feature operates both in scalar and vector control modes, ensuring maximum torque per ampere and reducing energy drawn from the supply. You can follow the saved energy, CO₂ emissions or money, and see how fast the drive brings you a return on investment.

The drive reduces motor noise by spreading the switching frequencies over a user-specified range. The higher used switching frequency reduces motor noise at low load without limiting full current at maximum load.

Diagnostic assistant helps in locating the cause of any disturbance to the drive, and even suggests possible remedies. This reduces process downtime by making repairs or adjustments effortless.

A built-in and stand-alone process PID/loop controller makes the drive a self-governing unit that requires no external logic input from the control room but requires only an external process measurement.

Load profile feature collects drive values, such as current and stores them in a log. This enables you to analyze and optimize the application with the help of historical data load.

Adaptive programming provides extra flexibility by offering easy alternative for simple programming needs.

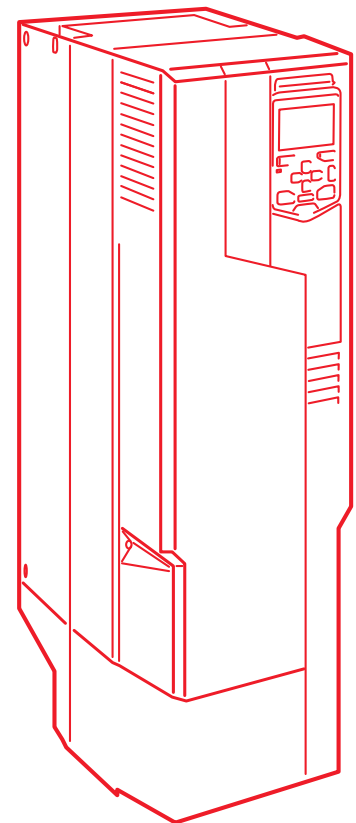

How to select a drive?

It is very easy to select the right drive. This is how you build up your own ordering code using the type designation key.

1 Start with identifying your supply voltage.

This tells you what rating table to use.
The ACQ580 supports 380 to 480 V.

2 Choose your motor's nominal power rating
from the ratings table on pages 16-18.

3 Select your drive's type code
from the rating table based on your motor's nominal power rating.

4 Choose your options.
Details about each option begin on page 21.
Add the option codes to the end of the drive's ordering code. Remember to use a "+" before each option code.

- Control panels 21-22
- Protection classes 24
- Flange mounting..... 24
- Quick configuration 25
- Remote monitoring 25
- Fieldbus adapters..... 26
- I/O extension and
thermistor protection modules 26-27
- EMC 29
- du/dt..... 30-31

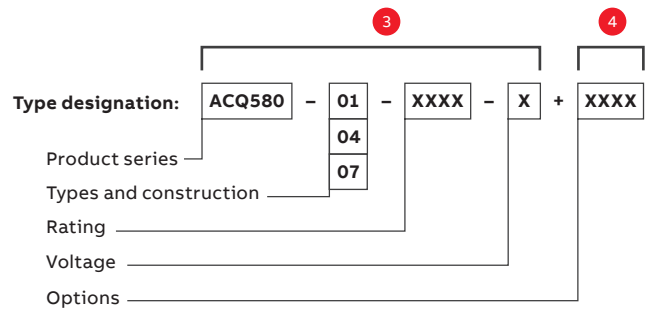

Example configuration:

ACQ580-01-145A-4+B056+J400+L501

Wall-mounted 145 A, 400 V drive in IP55 enclosure with Hand-Off-Auto control panel and internal CMOD-01 input/output option

Ratings, types and voltages

ACQ580-01, wall-mounted drives

Type	Power	Rated current	Rated voltage	Rated power	Rated torque
ACQ580-01-075	0.75	1.5	380-480	0.75	1.5
ACQ580-01-1.5	1.5	3.0	380-480	1.5	3.0
ACQ580-01-2.2	2.2	4.5	380-480	2.2	4.5
ACQ580-01-3	3	6.0	380-480	3	6.0
ACQ580-01-4	4	8.0	380-480	4	8.0
ACQ580-01-5.5	5.5	11.0	380-480	5.5	11.0
ACQ580-01-7.5	7.5	15.0	380-480	7.5	15.0
ACQ580-01-11	11	22.0	380-480	11	22.0
ACQ580-01-15	15	30.0	380-480	15	30.0
ACQ580-01-22	22	44.0	380-480	22	44.0
ACQ580-01-30	30	60.0	380-480	30	60.0
ACQ580-01-40	40	80.0	380-480	40	80.0
ACQ580-01-55	55	110.0	380-480	55	110.0
ACQ580-01-75	75	150.0	380-480	75	150.0
ACQ580-01-110	110	220.0	380-480	110	220.0
ACQ580-01-150	150	300.0	380-480	150	300.0
ACQ580-01-220	220	440.0	380-480	220	440.0
ACQ580-01-300	300	600.0	380-480	300	600.0
ACQ580-01-400	400	800.0	380-480	400	800.0
ACQ580-01-500	500	1000.0	380-480	500	1000.0

Pages 16-18

Ratings, types and voltages

01L, wall-mounted drives

Type	Power	Rated current	Rated voltage	Rated power	Rated torque
ACQ580-01L-075	0.75	1.5	380-480	0.75	1.5
ACQ580-01L-1.5	1.5	3.0	380-480	1.5	3.0
ACQ580-01L-2.2	2.2	4.5	380-480	2.2	4.5
ACQ580-01L-3	3	6.0	380-480	3	6.0
ACQ580-01L-4	4	8.0	380-480	4	8.0
ACQ580-01L-5.5	5.5	11.0	380-480	5.5	11.0
ACQ580-01L-7.5	7.5	15.0	380-480	7.5	15.0
ACQ580-01L-11	11	22.0	380-480	11	22.0
ACQ580-01L-15	15	30.0	380-480	15	30.0
ACQ580-01L-22	22	44.0	380-480	22	44.0
ACQ580-01L-30	30	60.0	380-480	30	60.0
ACQ580-01L-40	40	80.0	380-480	40	80.0
ACQ580-01L-55	55	110.0	380-480	55	110.0
ACQ580-01L-75	75	150.0	380-480	75	150.0
ACQ580-01L-110	110	220.0	380-480	110	220.0
ACQ580-01L-150	150	300.0	380-480	150	300.0
ACQ580-01L-220	220	440.0	380-480	220	440.0
ACQ580-01L-300	300	600.0	380-480	300	600.0
ACQ580-01L-400	400	800.0	380-480	400	800.0
ACQ580-01L-500	500	1000.0	380-480	500	1000.0

Pages 16-18

Effortless drive commissioning and use with control panels

A variety of different variants available of control panels and for the ACQ580 drives. Drive setup, maintenance, diagnostics and process monitoring is done via the control panel in an effortless manner.

Control panel	Description
CP01	The first ACQ580 control panel is the drive's control panel.
CP02	Control panel with a 12.1" touch screen.
CP03	Control panel with a 15" touch screen.
CP04	Control panel with a 15" touch screen and a 12.1" touch screen.
CP05	Control panel with a 15" touch screen and a 15" touch screen.
CP06	Control panel with a 15" touch screen and a 15" touch screen and a 12.1" touch screen.
CP07	Control panel with a 15" touch screen and a 15" touch screen and a 15" touch screen.
CP08	Control panel with a 15" touch screen and a 15" touch screen and a 15" touch screen and a 12.1" touch screen.
CP09	Control panel with a 15" touch screen and a 15" touch screen and a 15" touch screen and a 15" touch screen.
CP10	Control panel with a 15" touch screen and a 15" touch screen and a 15" touch screen and a 15" touch screen and a 12.1" touch screen.
CP11	Control panel with a 15" touch screen and a 15" touch screen and a 15" touch screen and a 15" touch screen and a 15" touch screen.
CP12	Control panel with a 15" touch screen and a 15" touch screen and a 15" touch screen and a 15" touch screen and a 15" touch screen and a 12.1" touch screen.
CP13	Control panel with a 15" touch screen and a 15" touch screen and a 15" touch screen and a 15" touch screen and a 15" touch screen and a 15" touch screen.
CP14	Control panel with a 15" touch screen and a 15" touch screen and a 15" touch screen and a 15" touch screen and a 15" touch screen and a 15" touch screen and a 12.1" touch screen.
CP15	Control panel with a 15" touch screen and a 15" touch screen and a 15" touch screen and a 15" touch screen and a 15" touch screen and a 15" touch screen and a 15" touch screen.
CP16	Control panel with a 15" touch screen and a 15" touch screen and a 15" touch screen and a 15" touch screen and a 15" touch screen and a 15" touch screen and a 15" touch screen and a 12.1" touch screen.
CP17	Control panel with a 15" touch screen and a 15" touch screen and a 15" touch screen and a 15" touch screen and a 15" touch screen and a 15" touch screen and a 15" touch screen and a 15" touch screen.
CP18	Control panel with a 15" touch screen and a 15" touch screen and a 15" touch screen and a 15" touch screen and a 15" touch screen and a 15" touch screen and a 15" touch screen and a 15" touch screen and a 12.1" touch screen.
CP19	Control panel with a 15" touch screen and a 15" touch screen and a 15" touch screen and a 15" touch screen and a 15" touch screen and a 15" touch screen and a 15" touch screen and a 15" touch screen and a 15" touch screen.
CP20	Control panel with a 15" touch screen and a 15" touch screen and a 15" touch screen and a 15" touch screen and a 15" touch screen and a 15" touch screen and a 15" touch screen and a 15" touch screen and a 15" touch screen and a 12.1" touch screen.

Technical specification

Mains connection	
Voltage and power range	3-phase, U_N 380 to 480 V, +10%/-15% 0.75 to 250 kW (-01) 250 to 500 kW (-04) 75 to 500 kW (-07)
Frequency	50/60 Hz $\pm 5\%$
Power factor	$\cos\varphi = 0.98$
Efficiency (at nominal power)	98%
Motor connection	
Voltage	0 to U_N , 3-phase
Frequency	0 to 500 Hz
Motor control	Scalar and vector control
Speed control	Static accuracy: 20% of motor nominal slip Dynamic accuracy: 1% seconds with 100% torque step
Product compliance	
CE Low Voltage Directive 2006/95/EC, EN 61800-5-1: 2007 Machinery Directive 2006/42/EC, EN 61800-5-2: 2007 EMC Directive 2004/108/EC, EN 61800-3: 2004 + A1: 2012 RoHS directive 2011/65/EU Quality assurance system ISO 9001 and Environmental system RCM ISO 14001 EAC UL, cUL TÜV Nord (safety functions)	
EMC according to EN 61800-3: 2004 + A1: 2017	
ACQ580-01 wall-mounted drive with built-in C2 category filter as standard (frames R0 to R9) ACQ580-04 drive module with built-in C3 category as standard (frames R10 to R11) ACQ580-07 cabinet-built drive with built-in C2 category filter as standard (frames R6 to R9) and built-in C3 category as standard (frames R10 to R11)	

Environmental limits	
Ambient temperature	
Transport	-40 to +70 °C
Storage	-40 to +70 °C
Operation area	ACQ580-01 Frames R1 to R9: -15 to +40 °C. No derating required, no frost allowed, +40 to +50 °C with derating 1% per 1 °C ACQ580-04 Frames R10 to R11: -15 to +40 °C. No derating required, no frost allowed. +40 to +55 °C with derating 1% per 1 °C ACQ580-07 Frames R6 to R11: 0 to +40 °C. No derating required, no frost allowed. +40 to +50 °C with derating 1% per 1 °C See HW manual for more information.
Cooling method	Air-cooled
Air-cooled	Dry clean air
Altitude	0 to 1.000 m Without derating 1.000 to 4.000 m With derating of 1%/100 m
Relative humidity	5 to 95%. no condensation allowed
Degree of protection	ACQ580-01: IP21 as standard and IP55 as option ACQ580-04: IP00 as standard and IP20 as option ACQ580-07: IP21 as standard IP42 and IP54 as option
Functional safety	Safe torque off (STO according EN 61800-5-2) IEC 61508 ed2: SIL 3, IEC 61511: SIL 3, IEC 62061: SIL CL 3, EN ISO 13849-1: PL e
Contamination levels	No conductive dust allowed
Storage	IEC 60721-3-1. Class 1C2 (chemical gases). Class 1S2 (solid particles)*
Operation	IEC 60721-3-3. Class 3C2 as standard and 3C3 as option (chemical gases). Class 3S2 (solid particles)*
Transportation	IEC 60721-3-2. Class 2C2 (chemical gases). Class 2S2 (solid particles)*

* C = chemically active substances
S = mechanically active substances

Securing the flow of water and wastewater with the ACQ580

The ACQ580 is a robust and compact drive ensuring low energy consumption and continuous, reliable motor control with a power and voltage range from 0.75 to 500 kW and 380 to 480 V. It has coated boards and offers enclosure classes up to IP55 for different environments. The drive is designed for water and wastewater pumps, blowers, mixers, centrifuges and fans.

—
01 The ACQ580 drive series

—
02 Flange mounting for panel installation ensures less thermal load inside the panel by keeping most of the losses outside the panel

Built-in pump functionality for optimal flow of water

Built-on ABB's common drives architecture, the drive offers pump operation, energy savings and usability benefits supported by a local network of service and support. The water and wastewater drive has several different built-in pump application features for optimal pump operation (see page 10).

Intuitive usability supported by simple connectivity

To ensure fast set-up and operation of the drive, adjusting drive settings has been made easy with the robust and intuitive Hand-Off-Auto control panel. The control panel has a powerful diagnostics menu that makes it possible to quickly access information, even in facilities with poor visibility. Drive usability is further enhanced via wireless Bluetooth connectivity between the drive and mobile devices, making it easy to access the drive in difficult-to-reach locations. Connectivity to automaton systems is ensured with the drive connecting to various fieldbus protocols. To ensure compliance with electric grids, the ACQ580 has a built-in 1st environment EMC filter and choke. The drive also supports functional safety design, as it offers integrated safety features with safe torque off (STO) built-in as standard.

The wall-mounted drive (ACQ580-01) offers flange mounting as an option, separating the control electronics from the main circuit cooling airflow, saving space and ensuring optimal cooling and extends the lifetime of the drive. The cabinet-built drive (ACQ580-07) offers flange mounting as a standard solution. This results in better thermal management in panel installation. The advanced pedestal system and ramp of the drive module (ACQ580-04) ensure easy installation and reduce time needed for setup and commissioning.



—
01



—
02

Complete offering from wall-mounted drives to cabinet installations

No matter the frame size or power range, all ACQ580 drives bring you ease of use, scalability and quality.

—
01 Wall-mounted
ACQ580 IP21 drive

—
02 Wall-mounted
ACQ580 IP55 drive

—
03 ACQ580 Drive
module IP00 drive

—
04 Cabinet-built
ACQ580 IP42 drive

The wall-mounted IP21 drives

The wall-mounted IP21 drives are available with the power and voltage range from 0.75 to 250 kW and 3-ph 380 to 480 V. Side-by-side mounting, flange mounting and horizontal mounting are all available for the wall-mounted ACQ580 drives.

The wall-mounted IP55 drives

The IP55 drive is designed for applications exposed to dust, moisture, vibrations and other harsh environments. It is similar in size to the compact IP21 drives, which provides significant savings in space, maintenance, engineering, material costs, as well as in setup and commissioning time.

Drive modules for cabinet installations

The ACQ580 drive modules are optimal for system integrators, cabinet builders or OEMs who want to optimize the cabined design in the 250 to 500 kW range, but do not want to compromise the easy installation, commissioning and maintenance.

Cabinet-built drives

The cabinet-built drives are type tested ABB solutions offering robust but easy to use cabinets with a new and innovative cooling arrangement. The ABB made cabinets have many in-built features as standard, delivered with short lead times and always made according to ABB's high quality standards. The design is available as standard for all available protection classes IP21 / 42 / 54 in frames R6 to R11. The power and voltage range is from 75 kW to 500 kW, 3-ph 380 to 480 V.

To select IP classes for the drive see page 24.



—
01



—
02



—
03



—
04

Ratings, types and voltages



ACQ580-01, wall-mounted drives

3-phase, $U_n = 400$ V (range 380 to 480 V). The power ratings are valid at nominal voltage 400 V (0.75 to 250 kW)

Type	Frame	Nominal ratings		Light-overload use		Maximum output current
		I_N (A)	P_N (kW)	I_{Ld} (A)	P_{Ld} (kW)	I_{Max} (A)
ACQ580-01-02A7-4	R1	2.6	0.75	2.5	0.75	3.2
ACQ580-01-03A4-4	R1	3.3	1.1	3.1	1.1	4.7
ACQ580-01-04A1-4	R1	4	1.5	3.8	1.5	5.9
ACQ580-01-05A7-4	R1	5.6	2.2	5.3	2.2	7.2
ACQ580-01-07A3-4	R1	7.2	3	6.8	3	10.1
ACQ580-01-09A5-4	R1	9.4	4	8.9	4	13
ACQ580-01-12A7-4	R1	12.6	5.5	12	5.5	14.1
ACQ580-01-018A-4	R2	17	7.5	16.2	7.5	22.7
ACQ580-01-026A-4	R2	25	11	23.8	11	30.6
ACQ580-01-033A-4	R3	32	15	30.4	15	44.3
ACQ580-01-039A-4	R3	38	18.5	36.1	18.5	56.9
ACQ580-01-046A-4	R3	45	22	42.8	22	67.9
ACQ580-01-062A-4	R4	62	30	58	30	76
ACQ580-01-073A-4	R4	73	37	68.4	37	104
ACQ580-01-088A-4	R5	88	45	83	45	122
ACQ580-01-106A-4	R5	106	55	100	55	148
ACQ580-01-145A-4	R6	145	75	138	75	178
ACQ580-01-169A-4	R7	169	90	161	90	247
ACQ580-01-206A-4	R7	206	110	196	110	287
ACQ580-01-246A-4	R8	246	132	234	132	350
ACQ580-01-293A-4	R8	293	160	278	160	418
ACQ580-01-363A-4	R9	363	200	345	200	498
ACQ580-01-430A-4	R9	430	250	400	200	545

Nominal ratings

I_N Rated current available continuously without overloadability at 40 °C.

P_N Typical motor power in no-overload use.

Light-overload use

I_{Ld} Continuous current allowing 110% I_{Ld} for 1 minute every 10 minutes at 40 °C.

P_{Ld} Typical motor power in light-overload use.

Maximum output current

I_{max} Maximum output current. Available for 2 seconds at start, then as long as allowed by drive temperature.

The ratings apply for the frames R1 to R9 up to +40 °C in enclosed IP class 21.

For derating at high altitudes, temperatures or switching frequencies, see the user's HW manual, document code: 3AXD50000035866.

Ratings, types and voltages



ACQ580-04, drive modules

3-phase, $U_n = 400$ V (range 380 to 480 V). The power ratings are valid at nominal voltage 400 V (250 to 500 kW)

Type	Frame	Nominal ratings		Light-overload use		Maximum output current
		I_N (A)	P_N (kW)	I_{Ld} (A)	P_{Ld} (kW)	I_{Max} (A)
ACQ580-04-505A-4	R10	505	250	485	250	560
ACQ580-04-585A-4	R10	585	315	575	315	730
ACQ580-04-650A-4	R10	650	355	634	355	730
ACQ580-04-725A-4	R11	725	400	715	400	1020
ACQ580-04-820A-4	R11	820	450	810	450	1020
ACQ580-04-880A-4	R11	880	500	865	500	1100

Nominal ratings

I_N Rated current available continuously without overloadability at 40 °C.

P_N Typical motor power in no-overload use.

Light-overload use

I_{Ld} Continuous current allowing 110% I_{Ld} for 1 minute every 10 minutes at 40 °C.

P_{Ld} Typical motor power in light-overload use.

Maximum output current

I_{max} Maximum output current. Available for 2 seconds at start, then as long as allowed by drive temperature.

The ratings apply for the frames R10 to R11 up to +40 °C in enclosed IP00/IP20.

For derating at high altitudes, temperatures or switching frequencies, see the user's HW manual, document code: 3AXD50000048677.

Ratings, types and voltages



ACQ580-07, cabinet-built drives

3-phase, $U_n = 400$ V (range 380 to 480 V). The power ratings are valid at nominal voltage 400 V (75 to 250 kW)

Type	Frame	Nominal ratings		Light-overload use		Maximum output current
		I_N (A)	P_N (kW)	I_{Ld} (A)	P_{Ld} (kW)	I_{Max} (A)
ACQ580-07-0145A-4	R6	145	75	138	75	178
ACQ580-07-0169A-4	R7	169	90	161	90	247
ACQ580-07-0206A-4	R7	206	110	196	110	287
ACQ580-07-0246A-4	R8	246	132	234	132	350
ACQ580-07-0293A-4	R8	293	160	278	160	418
ACQ580-07-0363A-4	R9	363	200	345	200	498
ACQ580-07-0430A-4	R9	430	250	400	200	545
ACQ580-07-0505A-4	R10	505	250	485	250	560
ACQ580-07-0585A-4	R10	585	315	575	315	730
ACQ580-07-0650A-4	R10	650	355	634	355	730
ACQ580-07-0725A-4	R11	725	400	715	400	1020
ACQ580-07-0820A-4	R11	820	450	810	450	1020
ACQ580-07-0880A-4	R11	880	500	865	500	1100

Nominal ratings

I_N Rated current available continuously without overloadability at 40 °C.

P_N Typical motor power in no-overload use.

Light-overload use

I_{Ld} Continuous current allowing 110% I_{Ld} for 1 minute every 10 minutes at 40 °C.

P_{Ld} Typical motor power in light-overload use.

Maximum output current

I_{max} Maximum output current. Available for 2 seconds at start, then as long as allowed by drive temperature.

The ratings apply for the frames R6 to R11 up to +40 °C in enclosed IP class 21

For derating at high altitudes, temperatures or switching frequencies, see the user's HW manual, document code: 3AXD50000045817.

Dimensions

ACQ580-01						
Frames	Height IP21*/IP55*	Width IP21/IP55	Depth IP21	Depth IP55	Weight IP21	Weight IP55
	mm	mm	mm	mm	kg	kg
R1	373/403	125/128	223	233	4.8	5.1
R2	473/503	125/128	229	239	6.5	6.7
R3	454/490	203/206	229	237	11.8	13.0
R4	636	203/206	257	265	19	20
R5	732	203	295	320	28.3	29
R6	727	252	369	380	42.4	43
R7	880	284	370	381	54	56
R8	965	300	393	452	69	77
R9	955	380	418	477	97	103

* Front height of the drive with glandbox



ACQ580-04				
Frames	Height	Width	Depth	Weight
	mm	mm	mm	kg
R10	1432	350	529	162
R11	1662	350	529	200



ACQ580-07				
Frames	Height	Width	Depth	Weight
	IP21	IP21	IP21	IP21
	mm	mm	mm	mm
R6	2145	430	673	210
R7	2145	430	673	220
R8	2145	530	673	255
R9	2145	530	673	275
R10	2145	830	698	535
R11	2145	830	698	581



Comprehensive connectivity

The ACQ580 drives offer a wide range of standard interfaces. In addition, the drive has two option slots that can be used for extensions including fieldbus adapter modules and input/output extension modules.

Default control connections to the CCU-23 control unit

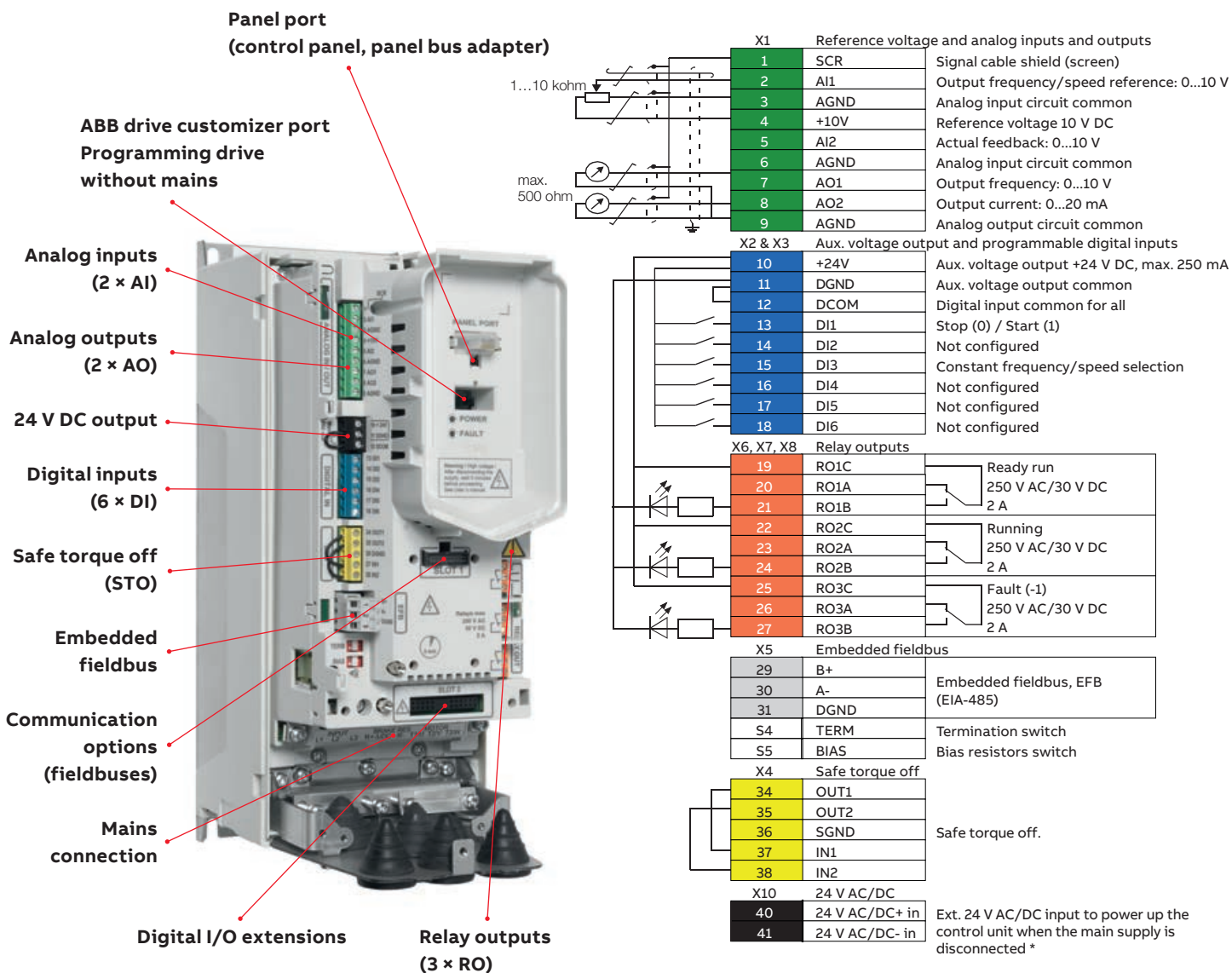

* Only available in the CCU-24 control unit

Hand-Off-Auto control panel

The control panel features intuitive use and easy navigation. High resolution display enables visual guidance.

Almost anyone can set up and commission the drive for water and wastewater using available control panels. You do not need to know any drive parameters as the control panel helps you to set up the essential settings quickly and get the drive into action.

Control of multiple drives

One control panel can be connected to several drives simultaneously using the panel network feature. The user can also select the drive to operate in the panel network.



- 1 With the customizable Home views you can monitor the values that matter most, e.g. pump speed, water flow or pressure, torque or motor temperature. Select the signals from a ready-made list or choose user defined parameters.
- 2 Options is used to set a reference, change the motor direction, select the drive, edit Home view pages, and see the fault and warning status.
- 3 All functions of the control panel are accessed through the main menu. It is easy to configure the settings of the drive with the Primary settings menu. Through Primary settings you can set all essential settings with few clicks only.
- 4 The help key provides context sensitive guidance. Faults or warnings can be resolved quickly since the help key provides troubleshooting instructions.
- 5 The PC tool can be easily connected to the drive through the USB connector on the control panel.

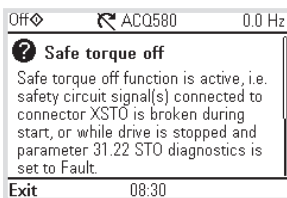

01

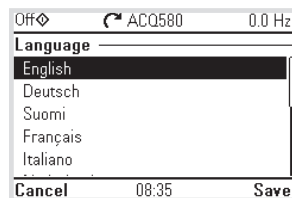

02

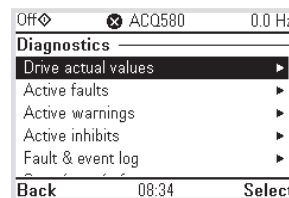

03

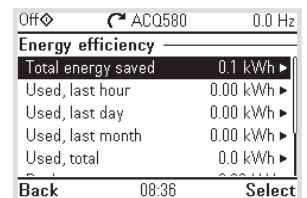

04

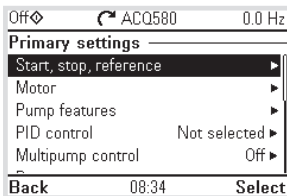

05

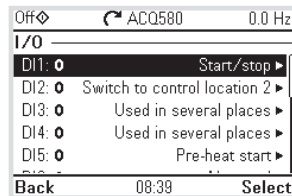

06

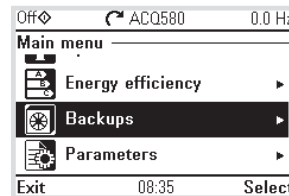

07

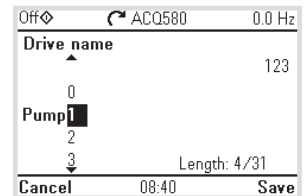

08

Assistant control panel display

01 Help button

- Detailed descriptions related to faults and warnings
- More information about Primary settings options

02 Language options

- Access to a selection list that consists mutually exclusive options such as the language selection list (Access through the main menu)

03 Diagnostics

- Diagnostic information, such as faults and warnings
- Helps to resolve potential problems
- Helps to make sure that the drive setup is functioning correctly

04 Energy efficiency

- View and configure parameters related to energy savings, such as kWh counters

05 Primary settings for ACQ580

With the primary settings you can set motor values, commission multipump, set level control, set soft pipe filling etc. pumping features. When using Primary settings, there is no need to browse the parameters.

06 I/O Menu

- Access to each terminal name, number and electrical status
- Possibility to force inputs and outputs
- Access to sub-menus that provides further information on the menu item and allow to make changes to the I/O connections

07 Backups

- Possibility to save parameter settings in the control panel memory and restore parameter settings from a backup to the drive

08 Text editor

Add information, customize text and label the drive

Effortless drive commissioning and use with control panels

A variety of different variants available of control panels and for the ACQ580 drives. Drive setup, maintenance, diagnostics and process monitoring is done via the control panel in an effortless manner.

01 Hand-Off-Auto control panel and Help function are included as standard. USB connection as standard.



01

02 The optional Hand-Off-Auto control panel with Bluetooth panel. USB connection as standard.



02



03

03 By using the panel bus adapter, CDPI-01 the assistant control panel is able to manage up to 32 drives.

04 The DPMP-01 control mounting platform is for flush mountings. It does not include the control panel. When using this with ACQ580, also CDPI-01 is required.



04

05 The DPMP-02 mounting platform is for surface mounting. It does not include the control panel. When using this with ACQ580, also CDPI-01 is required.



05



06

06 The door mounting kit DPMP-EXT is a ready-made kit consisting of the DPMP-02 and CDPI-01.

Control panel options

Option code	Description	Type designation
+J400	The Hand-Off-Auto control panel as standard in the delivery	ACH-AP-H
+J429	Control panel with Bluetooth interface	ACH-AP-W
+J425	Assistant Control panel with local/remote -logic	ACS-AP-I
+J424	Blank control panel cover (no control panel delivered)	CDUM-01
3AXD50000004419	Panel bus adapter	CDPI-01
3AUA0000108878	Control panel mounting platform (flush mounted, requires also panel bus adapter on the drive)	DPMP-01
3AXD50000009374	Control panel mounting platform (surface mounted, requires also panel bus adapter on the drive)	DPMP-02
3AXD50000016230*	Control panel mounting platform (surface mounted, requires also panel bus adapter on the drive, only for ACQ580-04)	DPMP-03
3AXD50000217717*	Control panel mounting kit for outdoor installation	DPMP-04
3AXD50000240319*	Control panel mounting kit for outdoor installation, only for ACQ580-04	DPMP-05
3AXD50000010763	Door mounting kit for the panel (for one drive, contains both DPMP-02 and CDPI-01)	DPMP-EXT

*For availability please contact your local ABB

Save time, ease troubleshooting and improve drive performance with ABB smartphone apps

Better connectivity and user experience with Drivetune

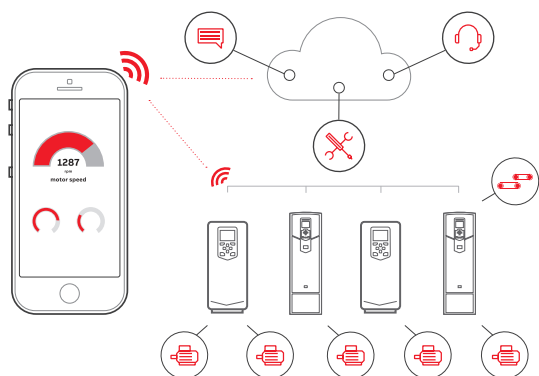

Easy and fast access to product information and support

Manage your drives and the process lines and machines they control



Easy access to cloud-based drive and process information from anywhere via an online connection



Start up, commission and tune your drive and application



Simplified user guidance with instant access to drive status and configuration



Performance optimization via drive troubleshooting features and fast support

Services and support on the go with Drivebase

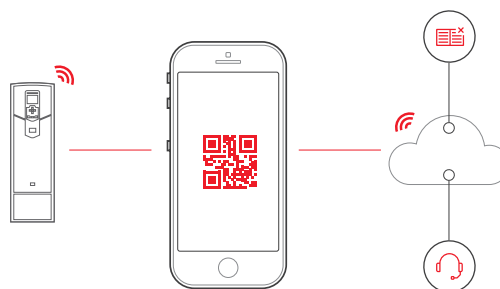

Search for support documents and contacts

Maintain and service all your installed drives on one or multiple sites



Get 6 months extra warranty for free by registering your drive with the Drivebase app



Access your product and service information in the cloud from anywhere



Access your drive's diagnostics data



Push notifications for critical product and service updates

Access information anywhere

Download the apps using the QR codes below or directly from the app stores



High protection for operation in harsh environments

The ACQ580 can be installed in normal equipment rooms, or even dusty and wet environments, thanks to the drive's wall-mountable construction in both IP21 and IP55 configurations. The module variant is as standard IP00 but available as IP20 with additional finger shrouds. The cabinet-built variant comes with IP21 as standard and is also available with IP42 and IP54 protection class for use in harsh environments.

Option code	Description
+B051	IP20 finger shrouds for modules
+B054 +B055	IP42, IP54 for cabinet-built drives
+B056	IP55 for wall-mountable drives

The robust and protective design ensures that no additional enclosures or components, such as filters and fans, are needed. Overall, the harsh protection drives provide smaller capital expenses by avoiding or advancing maintenance of external components, which in turn improves the reliability of the drive and the process. To ensure reliable operation, the printed circuit boards are also offered with coating to comply with class 3C3 in IP55 drives.

Option code	Description
+C218 +B056	3C3 rated PCBs



Flange mounting

The ACQ580 wall-mounted drive offers flange mounting as an option, separating the control electronics from the main circuit cooling airflow, saving space and ensuring optimal cooling. This results in better thermal management in panel installation.

Option code	Description
+C135	Flange mounting

Advanced cooling

The simple and robust design of the ACQ580-07 ensures reliable operation even in the harsh environments. The flange mounting feature comes as standard for cabinet-built ACQ580 drive, which makes the whole cooling arrangement of the cabinet advanced.

Quick configuration for unpowered drives

01 Cold configuration adapter CCA-01

02 Remote monitoring tool NETA-21

03 The Drive composer PC tool

Cold configuration adapter CCA-01 provides a serial communication interface for unpowered ACQ580 drives, among other selected drives. With the adapter and Drive Composer PC tool you can set the parameters and pre-configure the drive before sending it to site. The panel makes it also possible to isolate both the serial communication and power supply of the control unit. The power supply is taken from a PC USB port.

PC tool for drive monitoring and process tuning capabilities

The Drive composer PC tool offers fast and harmonized setup, commissioning and monitoring for the whole all-compatible drives portfolio. The free version of the tool provides startup and maintenance capabilities and gathers all drive information such as parameter loggers, faults, backups and event lists into a support diagnostics file with a single mouse click. This provides faster fault tracking, shortens downtime and reduces operational and maintenance costs. The entry version also includes AP programming.

The Drive composer tool is connected to the drive using the mini USB connection on the assistant control panel or to the CCA-01 adapter.

Drive composer pro offers extended functionality

Drive composer pro provides additional features such as custom parameter windows, graphical control diagrams of



Cold configurator adapter

Ordering code	Description	Type designation
3AXD50000019865	Cold configurator adapter, packed kit	CCA-01

Remote monitoring option

Ordering code	Description	Type designation
3AUA0000094517	2 x panel bus interface, 2 x 32 = max. 64 drives 2 x Ethernet interface SD memory card USB port for WLAN/3G	NETA-21

improved monitoring and diagnostics. The control diagrams save users from browsing long lists of parameters and help set the drive's logic quickly and easily. The tool has fast monitoring capabilities of multiple signals from several drives in the panel bus. Full backup and restore functions are also included.

Remote monitoring access worldwide

NETA-21, gives easy access to the drive via the Internet or local Ethernet network. NETA-21 comes with a built-in web server. Compatible with standard web browsers, it ensures easy access to a web-based user interface. Through the web interface, the user can configure drive parameters, monitor drive log data, load levels, run time, energy consumption, I/O data and bearing temperatures of the

Flexible connectivity to automation

—
01 ACQ580 is compatible with many fieldbus protocols and input/output extension modules

—
02 Input/output extension module CMOD-01

—
03 Fieldbus module FDNA-01

The drives for water and wastewater are compatible with a wide range of fieldbus protocols. The drive comes with a Modbus RTU fieldbus interface as standard. Optional fieldbus adapters can easily be mounted inside the drive.

Drive monitoring

The drive monitors and controls its parameters and signals including speed, torque, power, speed reference and pressure preference. Start/stop is monitored and controlled via the drives communication protocols. A set of drive parameters and/or actual signals, such as torque, speed, current, etc., can be selected for cyclic data transfer, providing fast data access.

Drive diagnostics

Accurate and reliable diagnostic information can be obtained through the alarm, limit and fault words, allowing easy interfacing with plantwide HMIs.

Cabling

Substituting the large amount of conventional drive control cabling and wiring with a single cable reduces costs and increases system reliability and flexibility.

Design

The use of a fieldbus control reduces engineering time at installation due to the modular structure of the hardware and software and the simplicity of the connections to the drives.

Commissioning and assembly

The modular product configuration allows pre-commissioning of single machine sections and provides easy and fast assembly of the complete installation.

Input/output extension modules

Standard input and output can be extended by using optional analog and digital input/output extension modules. The modules are easily installed

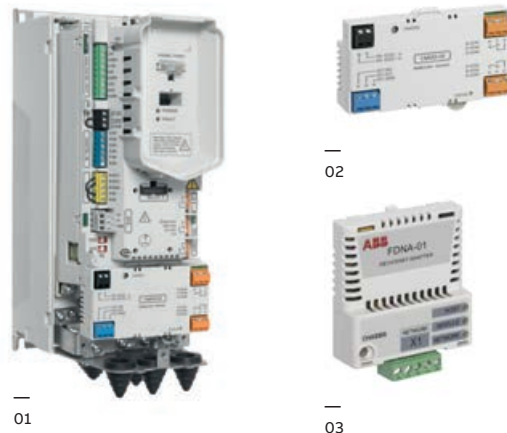

Fieldbus adapters

Option code	Fieldbus protocol	Adapter
+ K454	PROFIBUS-DP	FPBA-01
+ K451	DeviceNet	FDNA-01
+ K473	Ethernet (EtherNet/IP™, Modbus/TCP, PROFINET)	FENA-11
+ K458	Modbus/RTU	FSCA-01
+ K475	2-port Ethernet (EtherNet/IP™, Modbus/TCP, PROFINET)	FENA-21
+ K490*	Two-Port EtherNet/IP™ Adapter	FEIP-21
+ K491*	Two-Port Modbus/TCP Adapter	FMBT-21
+ K492*	Two-Port PROFINET IO Adapter	FPNO-21

*For availability please contact your local ABB

I/O options

Option code	Description	Type designation
+L501	External 24 V AC and DC 2 x RO and 1 x DO	CMOD-01
+L523	External 24 V and isolated PTC interface	CMOD-02
+L512	115/230 V digital input 6 x DI and 2 x RO	CHDI-01

CMOD options also enable connection to an external +24 V supply, which allows the control panel, control board, fieldbus and I/O to stay on when mains supply is cut off. With the external supply, drive

Thermistor protection modules for increased safety

01 ACQ580 supports the ATEX certified thermistor protection module

Standard input and output can be extended by using optional digital input/output extension modules. The modules are easily installed in the extension slot located on the drive. The CMOD options also enable connection to an external +24 V supply, which allows the control panel, control board, fieldbus and I/O to stay on when main supply is cut off. With the external supply, drive diagnosis and fault tracing can still be carried out.

The ATEX certified thermistor protection module CPTC-02 provides enhanced process safety and easy, simplified installation.



01

ABB's ATEX thermistor protection modules CPTC-02

With the option +L537 +Q971:

- 1 Motor temperature rises above the PTC sensor limit temperature
- 2 The sensor resistance increases very sharply and indicates overheating to the atex certified module
- 3 The module switches the STO (safe torque off) circuit off, which activates the STO function
- 4 The STO function disables the control voltage in the power semiconductors of the drive output stage
- 5 The drive is prevented from generating torque to rotate the motor

► The safe state is guaranteed

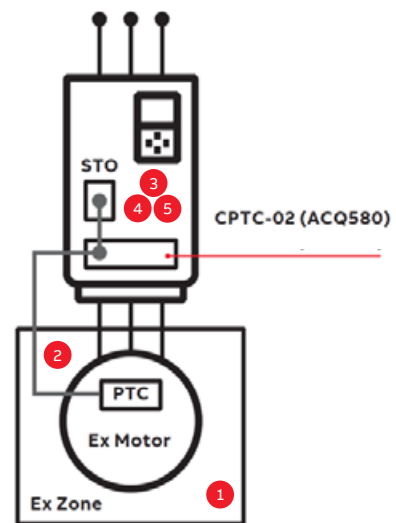

Thermistor protection module

Option code	Description	Type designation
+L537 +Q971	ATEX certified PTC interface and external 24V	CPTC-02

Main disconnect switch for increased safety

—
01 Main
disconnect switch
Possibility to disconnect
the drive from the
main supply

Main disconnect switch

The main disconnect switch option provides a possibility to disconnect the drive from the main supply when needed. This prewired main disconnect switch option saves time, money and space as it is integrated in the drive. There is no need to install an additional, external isolation devices to the supply side of the drive. The option improves safety as it is always visible, when operating on the drive.

Auxiliary contact allows signalling the switch position to PLC to avoid unnecessary controller alarms. The switch can be padlocked to open position to disable drive operation during e.g. maintenance.



—
01

Main disconnect switch

Option code	Description
+B056 +F278	IP 55 drive and main disconnect switch with auxiliary contact (NO)

EMC – electromagnetic compatibility

The ACQ580 drive has been designed to meet the EMC requirements set in the product standard IEC/EN61800-3. The wall-mounted ACQ580-01 and the small power cabinet-built ACQ580-07 drives meet category C2 high frequency emission limits as standard. The single standing drive module ACQ580-04 and high power ACQ580-07 cabinet-built drives meet category C3 limits without options.

EMC standards

The EMC product standard (EN 61800-3) covers the specific EMC requirements stated for drives (tested with motor and motor cable) within the EU. EMC standards such as EN 55011 or EN 61000-6-3/4 are applicable to industrial and domestic equipment and systems including components inside the drive. Drive units complying with the requirements of EN 61800-3 are compliant with comparable categories in EN 55011 and EN 61000-6-3/4, but not necessarily vice versa. EN 55011 and EN 61000-6-3/4 do not specify cable length or require a motor to be

connected as a load. The emission limits are comparable to EMC standards according to the table below.

Domestic environments versus public low voltage networks

1st environment includes domestic premises. It also includes establishments directly connected without an intermediate transformer to a low voltage power supply network that supplies buildings used for domestic purposes. 2nd environment includes all establishments directly connected to public low voltage power supply networks.

Built-in chokes to mitigate harmonics

ACQ580 drives are equipped with built-in chokes which provide sufficient level of harmonic mitigation for most operation environments. The ACS580-31 ultra-low harmonic drives are available for cases where extremely good low harmonic mitigation is required.

Comparison of EMC standards

EMC according to EN 61800-3 product standard	EN 61800-3 product standard	EN 55011. product family standard for industrial, scientific and medical (ISM) equipment	EN 61000-6-4, generic emission standard for industrial environments	EN 61000-6-3, generic emission standard for residential, commercial and light-industrial environment
1 st environment. unrestricted distribution	Category C1	Group 1. Class B	Not applicable	Applicable
1 st environment. restricted distribution	Category C2	Group 1. Class A	Applicable	Not applicable
2 nd environment. unrestricted distribution	Category C3	Group 2. Class A	Not applicable	Not applicable
2 nd environment. restricted distribution	Category C4	Not applicable	Not applicable	Not applicable

du/dt filters

du/dt filtering suppresses inverter output voltage spikes and rapid voltage changes that stress motor insulation. Additionally, du/dt filtering reduces capacitive leakage currents and high frequency emission of the motor cable as well as high frequency losses and bearing currents in the

motor. The need for du/dt filtering depends on the motor insulation. For information on the construction of the motor insulation, consult the manufacturer. More information on the du/dt filters can be found in the ACQ580 hardware manual.

du/dt filter selection table

Motor type	Nominal mains voltage (U_N)	Motor insulation requirement
ABB M2 and M3 motors	$U_N \leq 500$ V	Standard insulation system, including insulated N-end bearing
ABB form-wound HXR and AM motors	380 V < $U_N \leq 500$ V	Standard insulation system, including insulated N-end bearing
ABB random-wound HXR and AM motors	380 V < $U_N \leq 500$ V	ATEX certified thermistor protection module
Non-ABB random-wound and form-wound	$U_N \leq 420$ V	If the insulation system withstands $\hat{U}_{LL} = 1600$ V and $\Delta t = 0.2$ μ s, du/dt filtering is not required. With du/dt filtering the insulation system must withstand $\hat{U}_{LL} = 1300$ V.

U_N = Nominal mains voltage

\hat{U}_{LL} = Peak line-to-line voltage at motor terminals

Δt = Rise time, ie, interval during which line-to-line voltage at motor terminals changes from 10 to 90% of full voltage range

du/dt filter selection

External du/dt filters

	du/dt filter type																		
	Unprotected IP00						Protected to IP22						Protected to IP54						
	NOCH0016-60	NOCH0030-60	NOCH0070-60	NOCH0120-60	FOCH0260-70	FOCH0320-50	FOCH0610-70	FOCH0875-70	NOCH0016-62	NOCH0030-62	NOCH0070-62	NOCH0120-62	NOCH0016-65	NOCH0030-65	NOCH0070-65	NOCH0120-65	COF-01	COF-02	BOCH-0880A-7
ACQ580-01 400 V																			
ACQ580-01-02A7-4	.							.					.						
ACQ580-01-03A4-4	.							.					.						
ACQ580-01-04A1-4	.							.					.						
ACQ580-01-05A7-4	.							.					.						
ACQ580-01-07A3-4	.							.					.						
ACQ580-01-09A5-4	.							.					.						
ACQ580-01-12A7-4	.							.					.						
ACQ580-01-018A-4		.							.					.					
ACQ580-01-026A-4		.							.					.					
ACQ580-01-033A-4			.							.					.				
ACQ580-01-039A-4			.							.					.				
ACQ580-01-046A-4			.							.					.				
ACQ580-01-062A-4			.							.					.				
ACQ580-01-073A-4				.							.					.			
ACQ580-01-088A-4				.							.					.			
ACQ580-01-106A-4				.							.					.			
ACQ580-01-145A-4					.														
ACQ580-01-169A-4					.														
ACQ580-01-206A-4					.														
ACQ580-01-246A-4					.														
ACQ580-01-293A-4					.														
ACQ580-01-363A-4						.													
ACQ580-01-430A-4						.													
ACQ580-04 400 V																			
ACQ580-04-505A-4						.													
ACQ580-04-585A-4						.													
ACQ580-04-650A-4						.													
ACQ580-04-725A-4							.												
ACQ580-04-820A-4							.												
ACQ580-04-880A-4							.												
ACQ580-07 400 V																			
ACQ580-07-0145A-4																	.		
ACQ580-07-0169A-4																	.		
ACQ580-07-0206A-4																	.		
ACQ580-07-0246A-4																		.	
ACQ580-07-0293A-4																		.	
ACQ580-07-0363A-4																		.	
ACQ580-07-0430A-4																		.	
ACQ580-07-0505A-4																			.
ACQ580-07-0585A-4																			.
ACQ580-07-0650A-4																			.
ACQ580-07-0725A-4																			.
ACQ580-07-0820A-4																			.
ACQ580-07-0880A-4																			.

Cooling and fuses

Cooling

ACQ580 drives are fitted with variable-speed cooling fans. The speed-controlled fans cool the drive only when needed, reducing overall noise level and energy consumption.

Fuse connection

Standard fuses can be used with the ACQ580 drives. For input fuses, see the table below:

Wall-mounted drives, ACQ580-01

Cooling air flow and recommended input protection fuses for 380 to 415 V units

Type designation	Frame size	Cooling air flow 380 to 415 V units						Recommended input protection fuses for 380 to 415 V units***			
		Heat dissipation*		Air flow		Max. noise level**	IEC fuses		UL fuses		
		W	BTU/Hr	m ³ /h	ft ³ /min		A	Fuse type	A	Fuse type	
ACQ580-01-02A7-4	R1	45	155	34	20	56	4	gG	6	UL Class T	
ACQ580-01-03A4-4	R1	55	187	34	20	56	6	gG	6	UL Class T	
ACQ580-01-04A1-4	R1	66	224	34	20	56	6	gG	6	UL Class T	
ACQ580-01-05A7-4	R1	84	288	34	20	56	10	gG	10	UL Class T	
ACQ580-01-07A3-4	R1	106	362	50	29	55	10	gG	10	UL Class T	
ACQ580-01-09A5-4	R1	133	454	50	29	55	16	gG	15	UL Class T	
ACQ580-01-12A7-4	R1	174	593	50	29	55	16	gG	15	UL Class T	
ACQ580-01-018A-4	R2	228	777	128	75	66	25	gG	20	UL Class T	
ACQ580-01-026A-4	R2	322	1100	128	75	66	32	gG	30	UL Class T	
ACQ580-01-033A-4	R3	430	1469	116	68	71	40	gG	35	UL Class T	
ACQ580-01-039A-4	R3	525	1791	116	68	71	50	gG	45	UL Class T	
ACQ580-01-046A-4	R3	619	2114	116	68	71	63	gG	50	UL Class T	
ACQ580-01-062A-4	R4	1153	3938	280	165	69	80	gG	80	UL Class T	
ACQ580-01-073A-4	R4	1153	3938	280	165	69	100	gG	90	UL Class T	
ACQ580-01-088A-4	R5	1156	3948	280	165	62	100	gG	110	UL Class T	
ACQ580-01-106A-4	R5	1331	4546	435	256	67	125	gG	150	UL Class T	
ACQ580-01-145A-4	R6	1476	5041	435	256	67	160	gG	200	UL Class T	
ACQ580-01-169A-4	R7	1976	6748	450	265	67	250	gG	225	UL Class T	
ACQ580-01-206A-4	R7	2346	8012	550	324	67	315	gG	300	UL Class T	
ACQ580-01-246A-4	R8	3336	11393	550	324	65	355	gG	350	UL Class T	
ACQ580-01-293A-4	R8	3936	13442	550	677	65	425	gG	400	UL Class T	
ACQ580-01-363A-4	R9	4836	16516	1150	677	68	500	gG	500	UL Class T	
ACQ580-01-430A-4	R9	6036	20614	1150	677	68	700	gG	600	UL Class T	

* Heat dissipation value is a reference for cabinet thermal design.

** The maximum noise level at full fan speed. When the drive is not operating at full load and at maximum ambient temperature the noise level is lower.

*** For detailed fuse sizes and types, please see the A CQ580-01 HW manuals, document code: 3AXD50000035866

Cooling and fuses

Drive modules, ACQ580-04

Cooling air flow and recommended input protection fuses for 380 to 415 V units										
Type designation	Frame size	Cooling air flow 380 to 415 V units					Recommended input protection fuses for 380 to 415 V units***			
		Heat dissipation*		Air flow		Max. noise level**	IEC fuses		UL fuses	
		W	BTU/Hr	m ³ /h	ft ³ /min	dBA	A	Fuse type	A	Fuse type
ACQ580-04-505A-4	R10	5600	19132	1200	707	72	800	170M6812D	600	JJS-600
ACQ580-04-585A-4	R10	6400	21888	1200	707	72	1000	170M6814D	800	A4BY800
ACQ580-04-650A-4	R10	8100	27738	1200	707	72	1000	170M6814D	800	A4BY800
ACQ580-04-725A-4	R11	8700	29931	1200	707	72	1250	170M8554D	800	A4BY800
ACQ580-04-820A-4	R11	9800	33680	1200	707	72	1600	170M8557D	900	A4BY900
ACQ580-04-880A-4	R11	10500	36126	1420	848	72	1600	170M8557D	1000	A4BY1000

* Heat dissipation value is a reference for cabinet thermal design.

** The maximum noise level at full fan speed. When the drive is not operating at full load and at maximum ambient temperature the noise level is lower.

*** For detailed fuse sizes and types, please see the ACQ580-04 HW manual 3AXD50000048677

Cabinet-built drives, ACQ580-07

Cooling air flow and recommended input protection fuses for 380 to 415 V units										
Type designation	Frame size	Cooling air flow 380 to 415 V units					Recommended input protection fuses for 380 to 415 V units***			
		Heat dissipation*		Air flow		Max. noise level**	IEC fuses		UL fuses	
		W	BTU/Hr	m ³ /h	ft ³ /min	dBA	A	Fuse type	A	Fuse type
ACQ580-07-0145A-4	R6	1827	1801	685	982	67	250	170M3816D	250	DFJ-250
ACQ580-07-0169A-4	R7	2335	2317	700	1004	67	250	170M3816D	300	DFJ-300
ACQ580-07-0206A-4	R7	2738	2716	700	1004	67	315	170M3817D	300	DFJ-300
ACQ580-07-0246A-4	R8	3719	3719	800	1147	65	400	170M5408	400	170M5408
ACQ580-07-0293A-4	R8	4352	4352	800	1147	65	500	170M5410	500	170M5410
ACQ580-07-0363A-4	R9	5321	5314	1400	2007	68	630	170M6410	630	170M6410
ACQ580-07-0430A-4	R9	6589	6579	1400	2007	68	700	170M6411	700	170M6411
ACQ580-07-0505A-4	R10	5602	19132	2950	1837	72	800	170M6412	800	W1046956F
ACQ580-07-0585A-4	R10	6409	21888	2950	1837	72	900	170M6413	900	X1046957F
ACQ580-07-0650A-4	R10	8122	27738	2950	1837	72	1000	170M6414	1000	Y1046958F
ACQ580-07-0725A-4	R11	8764	29931	2950	1837	72	1250	170M6416	1250	A1046960F
ACQ580-07-0820A-4	R11	9862	33680	2950	1837	72	1250	170M6416	1250	A1046960F
ACQ580-07-0880A-4	R11	10578	36126	3170	1978	72	1400	170M6417	1400	B1046961F

* Heat dissipation value is a reference for cabinet thermal design.

** The maximum noise level at full fan speed. When the drive is not operating at full load and at maximum ambient temperature the noise level is lower.

*** For detailed fuse sizes and types, please see the ACQ580-07 HW manuals, document code: 3AXD50000045817

Choose the motor for your water application



Induction motors and the ACQ580 form a reliable combination

Induction motors are used throughout the industry in many water and wastewater applications and in a wide range of environments. ACQ580 drives fit perfectly together with this type of motor by providing comprehensive functionality yet simple operation. IE3 motors and our drives provide a perfect foundation for energy efficiency, while delivering capabilities such as exceeding nominal motor speed when maximum power is needed.



Permanent magnet motors and the ACQ580 for smooth operation

Permanent magnet technology is used for improved motor characteristics in terms of energy efficiency and compactness. This technology is particularly well-suited for low speed control applications, as they eliminate the need to use gear boxes. Even without speed or rotor position sensors, the ACQ580 drives control most types of permanent magnet motors.

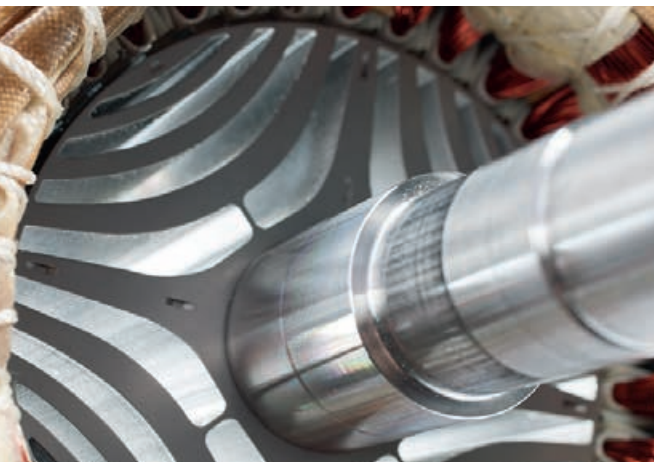

IE4 synchronous reluctance motors and the ACQ580 for optimized energy efficiency

Our drive and motor pairings guarantee your energy efficiency levels. The key is in the rotor design. Combining the ACQ580's control technology with our synchronous reluctance motors (SynRM) will give you a motor and a drive package that guarantees energy efficiency, reduces motor temperatures and provides a significant reduction in motor noise.

Ultimate efficiency and reliability to minimize your system cost of ownership

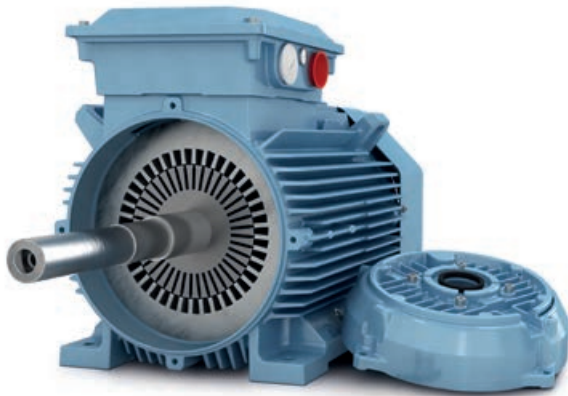

Traditional IE2 induction motor



IE4 SynRM motor

Losses

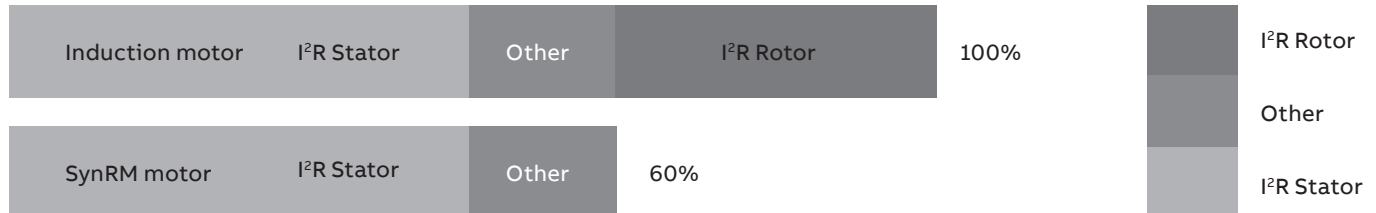

Innovation inside

The idea is simple. Take a conventional, proven stator technology and a totally new, innovative rotor design. Then combine them with a dedicated water industry drive loaded with new, application-designed software. Most of the pumps are constantly running at partial loads due to conservative design. With the Synchronous reluctance motor (SynRM) the energy efficiency remains at excellent levels also at partial loads.

Magnet-free design

Synchronous reluctance technology combines the performance of the permanent magnet motor with the simplicity and service-friendliness of an induction motor. The new rotor has neither magnets nor windings and suffers virtually no power losses. And because of identical footprints, maintenance is as straightforward as with induction motors.

Superior reliability to minimize the cost of not running

IE4 synchronous reluctance motors have very low winding temperatures, which increases the reliability and lifetime of the winding. More importantly, the cool synchronous reluctance rotor means significantly lower bearing temperatures – an important factor because bearing failures cause about 70 percent of unplanned motor outages.

WHOLE LIFE COST

$$= \text{Capital costs} + \text{Operating costs} + \text{Cost of NOT running}$$

ABB automation products



AC500

ABB's powerful flagship PLC offering provides wide range of performance levels and scalability within a single simple concept where most competitors require multiple product ranges to deliver similar functionality.



AC500-S

A PLC based modular automation solution that makes it easier than before to mix and match standard and safety I/O modules to expertly meet your safety requirements in all functional safety applications. "Extreme conditions" version is also offered.



Programmability

Automation Builder integrates the engineering and maintenance for PLC, drives, motion, HMI and robotics. It complies with the IEC 61131-3 standard offering all five IEC programming languages for PLC and drive configuration. Automation Builder supports a number of languages and comes with new libraries. FTP functions, SMTP, SNTP, smart diagnostics and debugging capabilities.



AC motors

ABB's low voltage AC motors are designed to save energy, reduce operating costs and enable demanding motor applications to perform reliably and without unscheduled downtime. General performance motors combine convenience and easy handling seamlessly with ABB's engineering expertise. Process performance motors provide the most comprehensive.



AC500-eCo

Meets the cost-effective demands of the small PLC market while offering total inter-operability with the core AC500 range. Web server, FTP server and Modbus-TCP for all Ethernet versions. A Pulse Train Out-put module is available

AC500-XC

"Extreme conditions" modules with extended operating temperature, immunity to vibration and hazardous gases. for use at high altitudes, in humid conditions. etc. It replaces expensive cabinets with its built-in protection against dirt, water, gases and dust.



Control panels

Our control panels offer a wide range of touchscreen graphical displays from 3.5" up to 15". They are provided with user-friendly configuration software that enables tailor made customized HMI solutions. Rich sets of graphical symbols and the relevant drivers for ABB automation products are provided. Control panels for visualization of AC500 web server applications are available.



All-compatible drives portfolio

The all-compatible drives share the same architecture; software platform, tools, user interfaces and options. Yet, there is an optimal drive from the smallest water pump to the biggest cement kiln, and everything in the between. When you have learned to use one drive it, is easy use the other drives in the portfolio.



Water library package

ABB's water library is compatible with the AC500 series PLC's. They provide advance pumping functions, data logging, remote access and reliable data communication. The libraries ensure saved engineering time and costs as well as ease of use with fast programming possibilities.



Softstarters

ABB's softstarters increase a motor's lifetime by protecting it from electrical stresses. With everything that you need in one unit, from bypass contactor to overload protection, a single Softstarter makes for a compact and complete



Securing the flow of water and wastewater in the pump system

We want to be part of securing the operation of your water and wastewater utilities and distribution system. We want to help prevent any interruptions in your pump operation. We also want to ensure that the water is flowing in an effortless and energy efficient manner in accordance with required standards and regulations.



Complete offering of devices and services for the water industry

As a global partner, we can manage your water assets and bring you clear benefits from a total cost of ownership perspective. We do this by reducing costs throughout the whole life cycle of your pumping solution. Our portfolio includes drives, motors, PLCs and sensors. We also offer remote monitoring solutions to access information from a pump operating at a distance, saving time and reducing costs. Our devices have been designed to be compatible with each other, which ensures reliable communication and functionality.

Proactive maintenance for minimizing disruption to your pump and water distribution system

Motor-driven applications can be found throughout the water and wastewater industry. They have a high degree of reliance placed upon them and often perform critical duties and have a high in-service value. A possible failure of a device in the water and wastewater distribution system can result in loss of production, and introduce safety and environmental consequences. To reduce the risk of failure, each element of the pump solution - whether a drive, motor, bearing, coupling or gearing - must be properly maintained at the right times in their life cycle. From the moment you make the first enquiry to the disposal and recycling of each component, the services offered by ABB span the entire life cycle of your pump. Throughout the value chain, training, technical support and customized

Services to match your needs

Your service needs depend on your operation, life cycle of your equipment and business priorities. We have identified our customers' four most common needs and defined service options to satisfy them. What is your choice to keep your drives at peak performance?

Is uptime your priority?

Keep your drives running with precisely planned and executed maintenance.

Example services include:

- ABB Ability Life Cycle Assessment
- Installation and Commissioning
- Spare Parts
- Preventive Maintenance
- Reconditioning
- ABB Drive Care agreement
- Drive Exchange

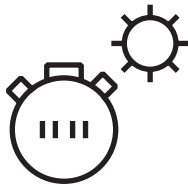

Operational efficiency

Is rapid response a key consideration?

If your drives require immediate action, our global network is at your service.

Example services include:

- Technical Support
- On-site Repair
- ABB Ability Remote Assistance
- Response time agreements
- Training

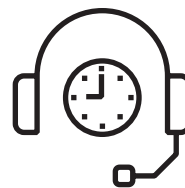

Rapid response

Drives service

Your choice, your future

The future of your drives depends on the service you choose.

Whatever you choose, it should be a well-informed decision. No guesswork. We have the expertise and experience to help you find and implement the right service for your drive equipment. You can start by asking yourself these two critical questions:

- Why should my drive be serviced?
- What would my optimal service options be?

From here, you have our guidance and full support along the course you take, throughout the entire lifetime of your drives.

Your choice, your business efficiency

ABB Drive Care agreement lets you focus on your core business. A selection of predefined service options matching your needs provides optimal, more reliable performance, extended drive lifetime and improved cost control. So you can reduce the risk of unplanned downtime and find it easier to budget for maintenance.

We can help you more by knowing where you are!

Register your drive at www.abb.com/drivereg for extended warranty options and other benefits.

Option code	Description
+P932	ACQ580 extension of warranty to 60 months from delivery

Need to extend your assets' lifetime?

Maximize your drive's lifetime with our services.

Example services include:

- ABB Ability Life Cycle Assessment
- Upgrades, Retrofits and Modernization
- Replacement, Disposal and Recycling

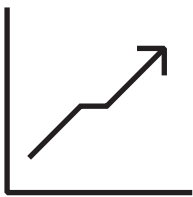

Life cycle management

Is performance most critical to your operation?

Get optimal performance out of your machinery and systems.

Example services include:

- ABB Ability Remote Services
- Engineering and Consulting
- Inspection and Diagnostics
- Upgrades, Retrofits and Modernization
- Workshop Repair
- Tailored services

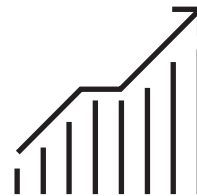

Performance improvement

A lifetime of peak performance

You're in control of every life cycle phase of your drives. At the heart of drive services is a four-phase product life cycle management model. This model defines the services recommended and available throughout drives lifespan.

Now it's easy for you to see the exact service and maintenance available for your drives.

ABB drives life cycle phases explained:

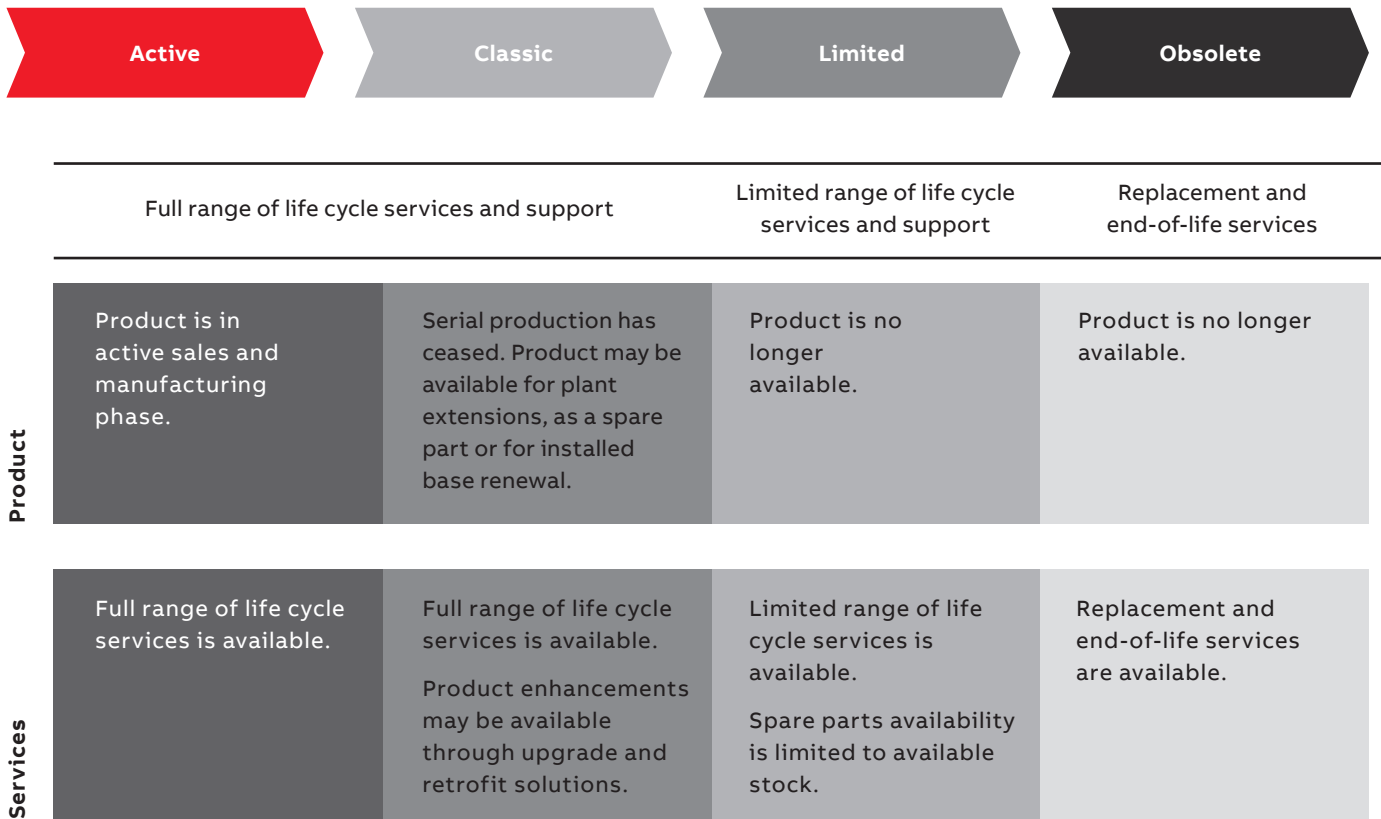

Keeping you informed

We notify you every step of the way using life cycle status statements and announcements.

Your benefit is clear information about your drives' status and precise services available. It helps you plan the preferred service actions ahead of time and make sure that continuous support is always available.

Step 1

Life Cycle Status Announcement

Provides early information about the upcoming life cycle phase change and how it affects the availability of services.

Step 2

Life Cycle Status Statement

Provides information about the drive's current life cycle status, availability of product and services, life cycle plan and recommended actions.

—
For more information, please contact
your local ABB representative or visit

abb.com/drives
abb.com/drivespartners
abb.com/motors&generators

Online manuals for wall-mounted ACQ580 drives



Online manuals for ACQ580 drive modules



Online manuals for cabinet-built ACQ580 drives

