

STACKABLE CHECK VALVES

AM5-CP-*

100 l/min 32 MPa (320 bar)

1 DESCRIPTION

Pilot operated check valve. All the internal part are made with high strenght steel and are machined with accuracy in order to assure the requested tightness. The controlled lines are A, B or AB. The standard surface treatment of the body is phosphate coated. Plugs are zinc coated.

2 ORDERING CODE

(1)	(2)	(3)	(4)	(5)	(6)
AM5	-	CP	-	-	/ 10

- (1) AM5 : stackable valve CETOP 05 - Pressure 32 MPa (320 bar)
- (2) CP : check valve, pilot operated (hydraulically)
- (3) Service lines where the controls operates:
 AB: p.o. checks on A and B. Fluid flows A->A1 and B->B1 and flow A1 ->A (or B1->B) is permitted only when B (or A) is pressurized
 A: p.o. check on A; flow A1->A is permitted only when B is pressurized
 B: p.o. check on B; flow B1->B is permitted only when A is pressurized
- (4) Check valve opening (cracking) pressure (Pm) for free flow A->A1 and B->B1 no designation (standard): Pm approx 0.2 MPa (2 bar)
- (5) Code reserved for special variants (materials, seals, surface treatments, etc.)
- (6) Design number (progressive) of the valves.

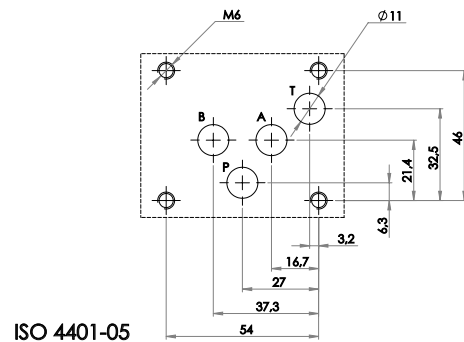
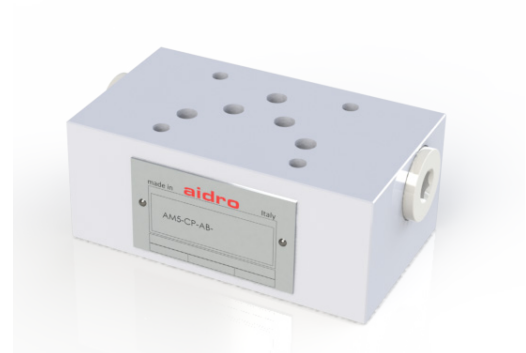

AM5-CP-AB

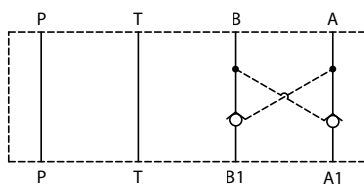

AM5-CP-A

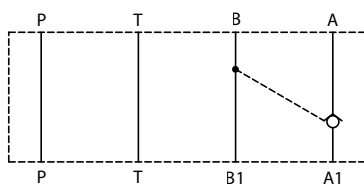

AM5-CP-B

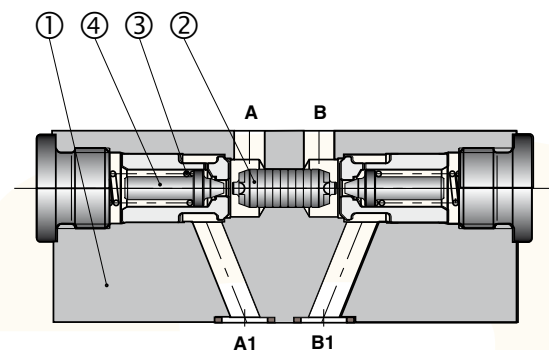
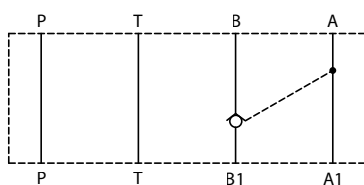

Fluid flows freely on P and T lines; on service lines A and/or B with p.o. check, fluid flows from A -> A1 (and/or B -> B1) overcoming the force of spring acting on poppet 4, and fluid is blocked from A1-> A (and/or B1-> B). When, by switching the solenoid operated 4-way directional valve, pressure is made available at, for instance, port B fluid flows B -> B1 and the pilot piston 2, shifting from its central position, forces poppet 4, on service line A, to open and permit flow A1 -> A. The valve housing 1 is phosphatate coated.

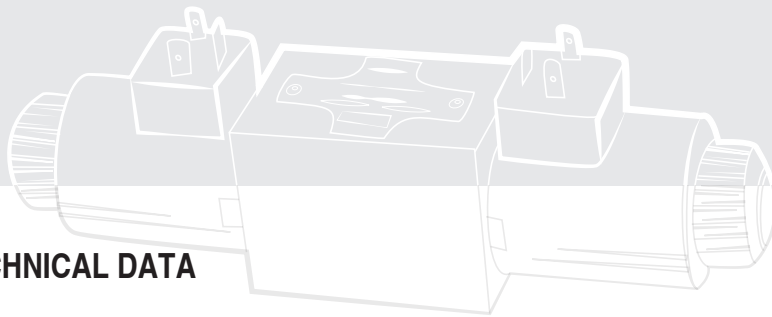

3 TECHNICAL DATA

Maximum rec. flow rate	100 l/min	Piloting pressure:
Maximum nominal pressure	32 MPa (320 bar)	To shift the pilot piston and to open the check in A the piloting pressure must be, at B:
Pressure drops	see 4	$P_p = P_b = \frac{P_{a1} + P_m - P_a}{5,6} + P_a$
Pilot area ratio piston/poppet	approx 5,6	where: P_p = piloting pressure; P_b = pressure in B;
Installation and dimensions	see 5	P_a = pressure in A; P_{a1} = pressure in A1;
Mass	approx 3 kg	P_m = check valve opening pressure (spring)
		or to open the check in B:
		$P_p = P_a = \frac{P_{b1} + P_m - P_b}{5,6} + P_b$

4 TYPICAL DIAGRAMS

Typical Δp -Q curves for valves AM5-CP-AB in standard configuration, with mineral oil at 36 cSt and at 50°C.

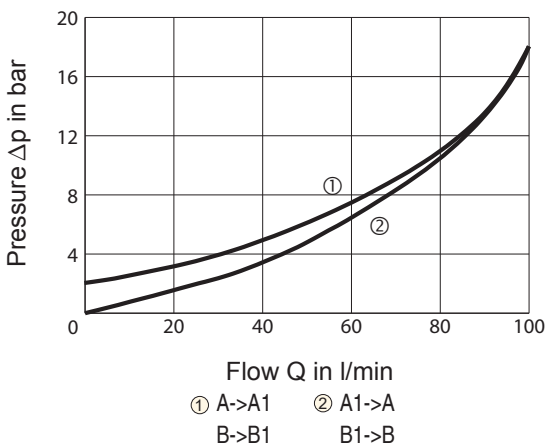

5 INSTALLATION DIMENSIONS

Seals:
5 x OR 12,5 x 1,68
or
5 x QR14S 12,42 x 1,68

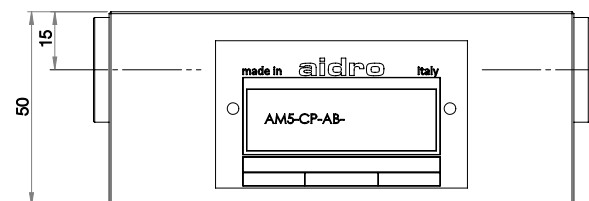
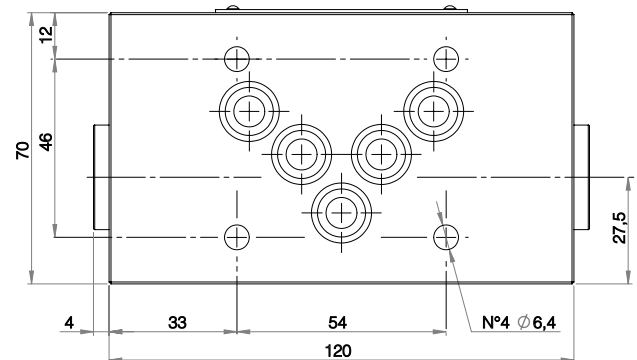

6 HYDRAULIC FLUIDS

Seals and materials used on standard valves AM5-* are fully compatible with hydraulic fluids of mineral oil base, upgraded with antifoaming and antioxidizing agents. The hydraulic fluid must be kept clean and filtered to ISO 4406 class 19/17/14, or better, and used in a recommended viscosity range from 10 cSt to 60 cSt.

All stackable valves AM5-CP-* conform with ISO and CETOP specifications for mounting surface dimensions and for valves height (50mm). Leakage between valve and mounting surface is prevented by the positive compression on their seats of seals (of OR type or Quading type).