

# **LONCIN**

## **OWNER'S MANUAL**

---

---

### LC2000i



Read this manual carefully before operating this machine.

## **FOREWORD**

Thank you for purchasing our generator set (hereinafter referred to as a generator).

- The copyright of the Manual is reserved to our company.
- No part of this publication may be reproduced, transmitted, distributed or stored without prior written permission of our company.
- Our company adheres to a strategy of sustainable development, so we reserve the right to make changes or improvements without notice to any product described in this publication.
- In order to check the manual in any time, please take this manual with yourself.
- This manual should be considered a permanent part of the generator and should remain with it if it is resold.
- This manual contains the information about how to use the generator correctly, please read it carefully before operating the generator. Safe and correct operation of the generator will give you the best results.

## Safety Warnings

Personal safety and property safety of you and others are very important. .  
Please read these messages which is preceded by a symbol  or NOTICE carefully.

### DANGER

You WILL be SERIOUSLY HURT if you don't follow instructions.

### WARNING

You CAN be SERIOUSLY HURT if you don't follow instructions.

### CAUTION

You CAN be HURT if you don't follow instructions.

### NOTICE

Your generator or other property could be damaged if you don't follow instructions.

# CONTENTS

SAFETY INFORMATION.....	6
LOCATION OF IMPORTANT LABELS.....	10
DESCRIPTION.....	12
Control panel .....	12
CONTROL FUNCTION.....	13
3 in 1 switch knob (including start/stop switch, fuel valve and chock) .....	13
Oil warning light (red).....	14
Overload indicator light (Red).....	14
AC pilot light (Green) .....	15
DC protector.....	15
ESC switch.....	16
Fuel tank cap.....	16
Fuel tank cap air vent knob.....	16
Ground (Earth) terminal.....	17
Parallel Operation Outlets terminal .....	17
PREPARATION.....	18
Fuel.....	18
Engine oil.....	19
Pre-operation check.....	20
OPERATION .....	21
Starting the engine .....	21
Stopping the engine .....	23
Alternating Current (AC) connection .....	25
AC parallel operation .....	27
Application range.....	29
PERIODIC MAINTENANCE .....	30
Maintenance chart.....	30
Spark plug inspection.....	31
Carburetor adjustment.....	33

Engine oil replacement.....	33
Air filter .....	34
Muffler screen and spark Arrester.....	35
Fuel tank filter.....	37
STORAGE.....	39
Drain the fuel.....	39
Engine .....	40
TROUBLESHOOTING .....	40
Engine won't start .....	40
Generator won't produce power .....	41
PARAMETERS .....	41
WIRING DIAGRAM.....	42

## SAFETY INFORMATION

Read and understand this owner's manual before operating your generator. It will help you avoid accidents if you get familiar with your generator's safe operation procedures.

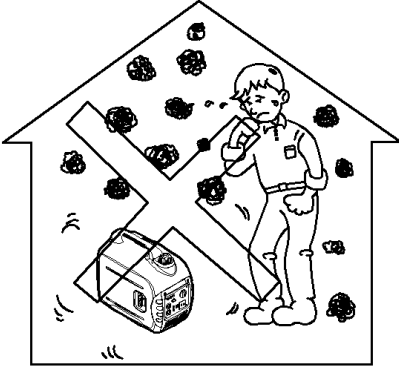

Never use it indoors

Never directly connect it to a home power system

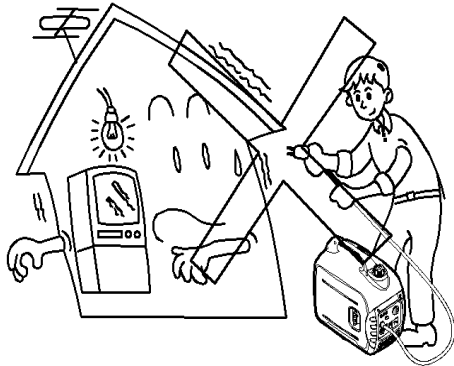

Never use it in a wet condition

Keep it at least 1m away from Inflammables

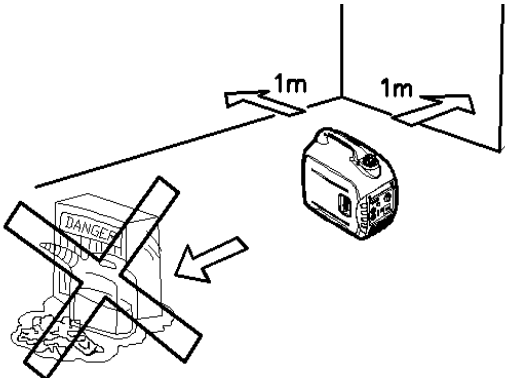

Never smoke when fueling

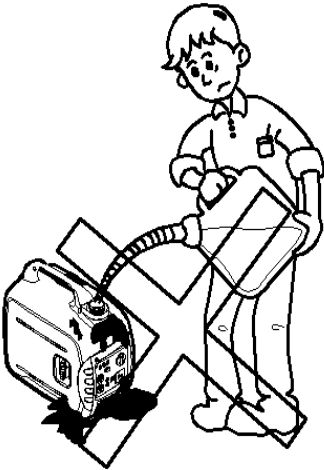

Don't spill when fueling

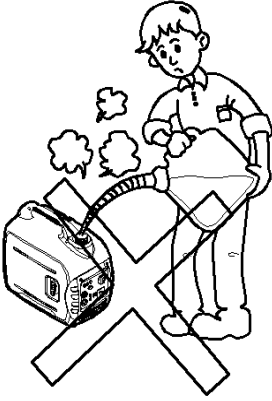

Stop the engine before fueling

○ RIGHT

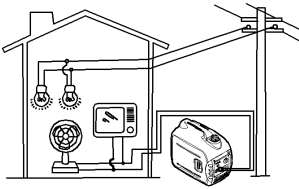

× WRONG

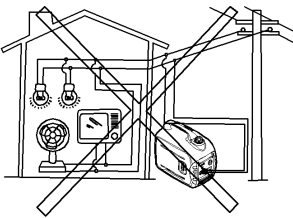

## Connections to a Home Power Supply

### NOTICE

If the generator is to be connected to a home power supply as a standby, connection shall be performed by a professional electrician or by another person with proficient electrical skill. When the loads are connected to the generator, please carefully check whether electrical connections are safe and reliable. Any improper connection may cause damage to the generator, or cause a fire.

○ RIGHT

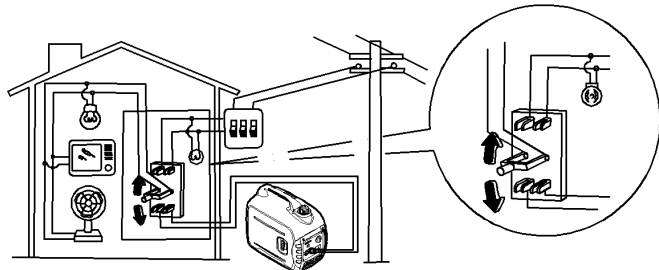



## Generator Ground Circuit

In order to prevent electric shock due to shoddy electrical appliances or wrong use of electricity, the generator must be grounded with a good-quality insulated conductor.

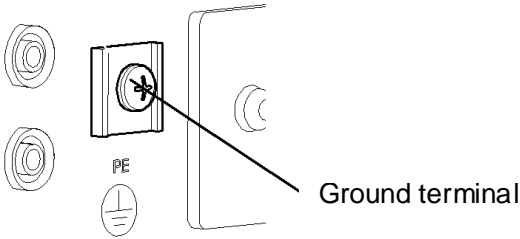

### NOTICE

Make sure the control panel, louver and the inverter bottom side cooling well and without chips, mud and water come in. It may damage the generator, inverter or alternator if the cooling vent blocked.

Do not mix the inverter with other stuff If moving, storing or running the unit. It may cause inverter damage or bring property safety issue when the inverter in leakage.

## LOCATION OF IMPORTANT LABELS

Please read the following labels carefully before operation this machine.

**TIP:** Maintain or replace safety and instruction labels, as necessary.

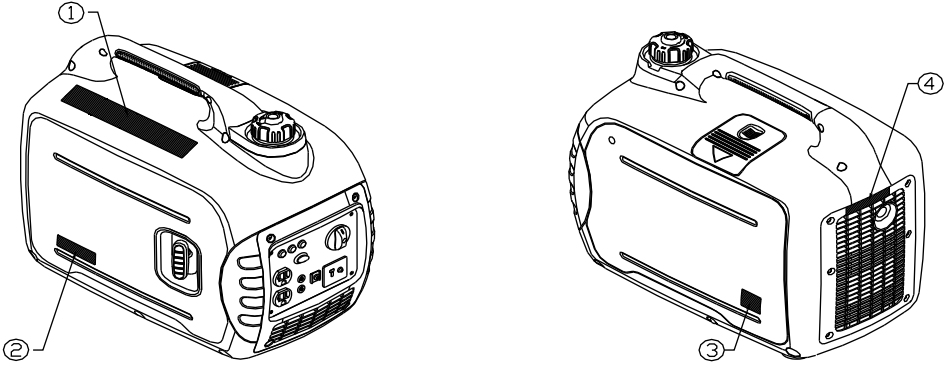

①

### **WARNING**

- Among engine exhaust air, there is toxic CO. So never use in an enclosed room without good ventilation.
  - Gasoline is highly flammable and explosive. Before refueling, stop the engine and keep heat, sparks, and flame away.
  - Operate only in dry areas away from moisture, rain, snow or standing water.
  - Before operation. Be sure to add specified engine oil into the crankcase.
- Please refer to the **OWNER'S MANUAL** for further information.

### **WARNING**

- Make sure the ground wire be connected as the electricity component requirement before start.
- Generator electrical backfeed utility system can cause serious injury or death to utility workers and cause property damage.
- Do not connect to any building electrical system unless using an approved device installed by a qualified electrician that disconnects utility main supply before connecting the generator.

②230V 50Hz

## LC2000i

Inverter Generator

GENERATING SET ISO 8528 (Low Power Generating Set)

Rated Power COP 1.6kW	50Hz	AC 230V 7A DC 12V 8.3A
Rated Power factor 1.0	G2 / IP23M	Maximum elevation 1000m
Fire Protection ISO 6826	Quality CLASS A	Max.ambient temperature 40°C

Loncin Motor Co.,Ltd.

No.99 Hualong Road,Jiulong Industrial Park,Jiulongpo District,Chongqing,China

③



④



## DISCRIPTION

- ① Garrying handle
- ② Fuel tank cap air vent knob
- ③ Fuel tank cap
- ④ Control panel
- ⑤ Recoil starter
- ⑥ Oil filler cap
- ⑦ Louver
- ⑧ Muffler
- ⑨ Spark plug maintenance cover

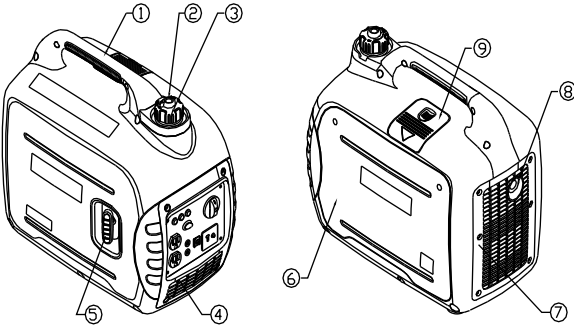

## Control panel

### A. 120V 60Hz

- ① Oil warning light
- ② Overload indicator light
- ③ AC pilot light
- ④ ESC(Engine Smart Control)
- ⑤ 3 in 1 switch knob (including start/stop switch, fuel valve and chock)
- ⑥ AC receptacle
- ⑦ Parallel receptacle
- ⑧ Ground (earth) terminal
- ⑨ DC receptacle
- ⑩ DC protector

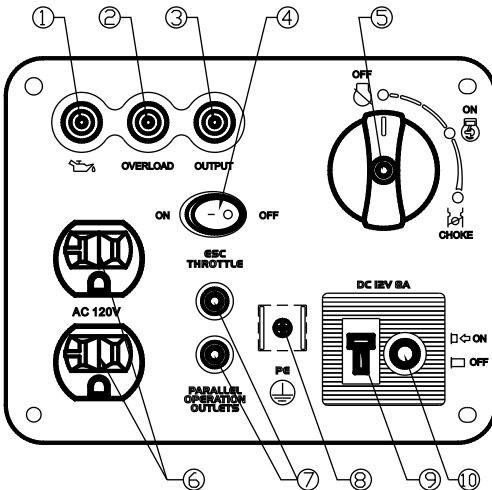

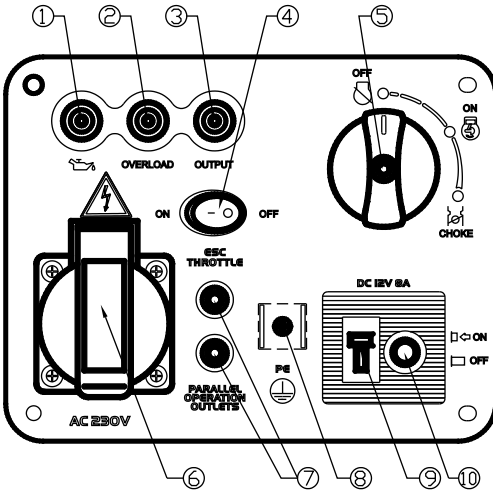



## B. 230V 50Hz

- ① Oil warning light
- ② Overload indicator light
- ③ AC pilot light
- ④ ESC(Engine Smart Control)
- ⑤ in 1 switch knob (including start/stop switch, fuel valve and choke)
- ⑥ AC receptacle
- ⑦ Parallel receptacle
- ⑧ Ground (earth) terminal
- ⑨ DC receptacle
- ⑩ DC protector

## CONTROL FUNCTION

### 3 in 1 switch knob

- ① Engine switch \fuel valve  "OFF"; Ignition circuit is switched off. Fuel is switched off. The engine will not run.
- ② Engine switch \fuel valve \ choke  "ON" Ignition circuit is switched on. Fuel is switched on. choke is switched on. The engine can be running.
- ③ Engine switch \fuel valve \ choke  "ON" Ignition circuit is switched on. Fuel is switched on. choke is switched off. The engine can be start.

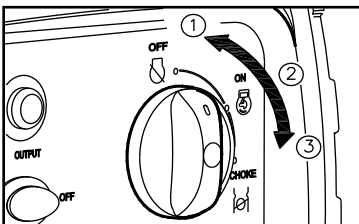

**TIP:** The choke "  " is not required to start a warm engine.

## Oil warning light (red)

When the oil level falls below the lower level, the oil warning light comes on and then the engine stops automatically. Unless you refill with oil, the engine will not start again.

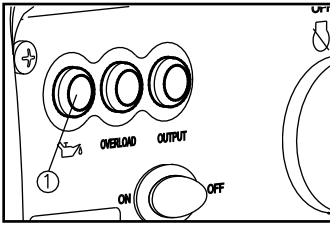

**Tip:** If the engine stalls or does not start, turn the engine switch to “ON” and then pull the recoil starter.

If the oil warning light flickers for a few seconds, the engine oil is insufficient. Add oil and restart.

## Overload indicator light (Red)

The overload indicator light ① comes on when an overload of a connected electrical device is detected, the inverter control unit overheats, or the AC output voltage rises. Then, the AC protector will trip, stopping power generation in order to protect the generator and any connected electric devices. The AC pilot light (Green) will go off and the overload indicator light (Red) will stay on, but the engine will not stop running.

When the overload indicator light comes on and power generation stops, proceed as follows:

1. Turn off any connected electric devices and stop the engine.
2. Reduce the total wattage of connected electric devices within the rated output.
3. Check for blockages in the cooling air inlet and around the control unit. If any blockages are found, remove.
4. After checking, restart the engine.

**TIP:** The overload indicator light may come on for a few seconds at first when using electric devices that require a large starting current, such as a compressor or a submersible pump. However, this is not a malfunction.

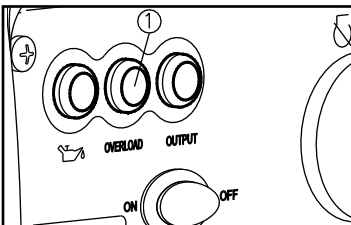

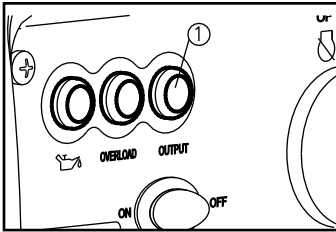

## AC pilot light (Green)

The AC pilot light ① comes on when the engine starts and produces power.

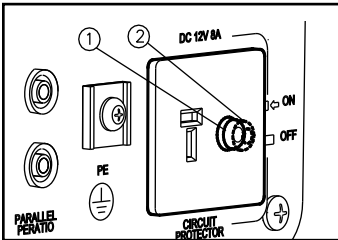

## DC protector

The DC protector turns to “OFF” ② automatically when electric device being connected to the generator is operating and current above the rated flows. To use this equipment again, turn on DC protector by pressing its button to “ON” ①

① “ ON”

Direct current is output.

② “ OFF”

Direct current is not output.

## **⚠ CAUTION**

Reduce the load of the connected electric device below the specified rated output of the generator if the DC protector turns off. If the DC protector turns off again, stop using the device immediately and consult a LONCIN dealer.

## Engine smart control (ESC)

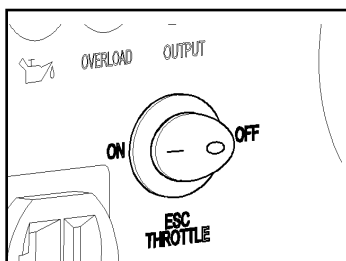

- "ON"  
When the ESC switch is turned to "ON", the economy control unit controls the engine speed according to the connected load. The results are better fuel consumption and less noise
- "OFF"  
When the ESC switch is turned to "OFF", the engine runs at the rated r/min (5000r/min) regard-less of whether is a load connected or not.

**Tip:** The ESC must be turned to "OFF" when using electric devices that require a large starting current, such as a compressor of a submersible pump

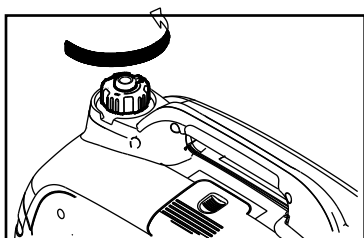

## Fuel tank cap

Remove the fuel tank cap by turning it counterclockwise.

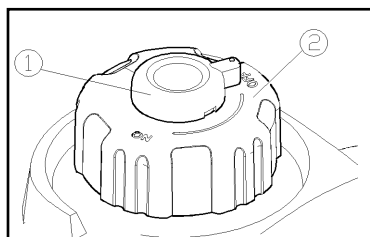

## Fuel tank cap air vent knob

The fuel tank cap ② is provided with an air vent knob to ① stop fuel flow. The air vent knob must be turned to "ON". This will allow fuel to flow to the carburetor and the engine to run. when the engine is not in use, turn the air vent knob to "OFF" to stop fuel flow.



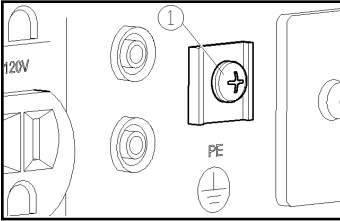

## Ground (Earth) terminal

Ground (Earth) terminal ① connects the earth line for prevention of electric shock. When the electric device is earthed, always the generator must be earthed.

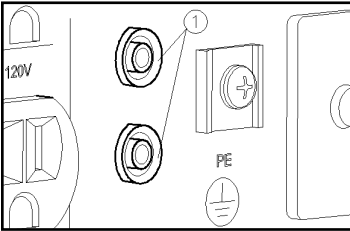

## Parallel Operation Outlets

This is the terminal ① for connecting special cables for parallel running of two LC2000i. The parallel running requires two LC2000i and the special cables. (The rated output in parallel running is 3.0Kva and the rated current is 25.0 A/120V 13A/230V.) The handling, operation procedure and the notes on usage are described in the PARALLEL RUNNING KIT OWNER'S MANUAL included in the Parallel Running Kit. Consult a LONCIN dealer for this Parallel Running Kit.

# PREPARATION

## Fuel

### **⚠ DANGER**

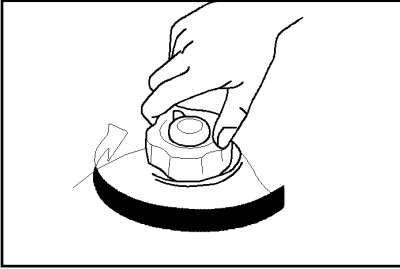

- Fuel is highly flammable and poisonous. Check “SAFETY INFORMATION”(See page 1) carefully before filling.
- Do not overfill the fuel tank, otherwise it may overflow when the fuel warms up and expands.
- After fill the fuel, make sure the fuel tank cap is tightened securely.

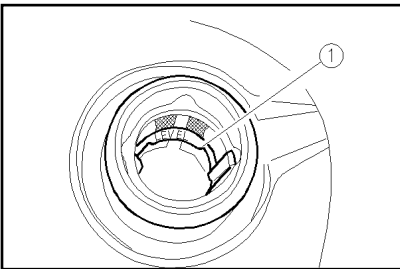

### **NOTICE**

- Immediately wipe off spilled fuel with a clean, dry, soft cloth, since fuel may deteriorate painted surfaces or plastic parts.
- Use only unleaded gasoline. The use of leaded gasoline will cause severedamage to internal engine parts.

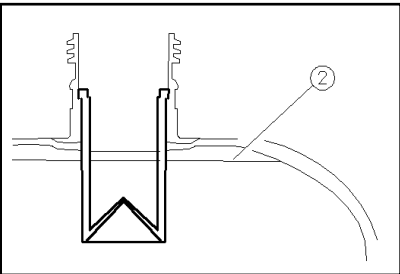

Remove the fuel tank cap and fill the fuel into the tank up to the red level.

- ① Red line
- ② Fuel level

Recommended fuel:  
Unleaded gasoline  
Fuel tank capacity:  
Total: 4.0L(1.06 US gal, 0.88 Imp gal)

## Engine oil

### NOTICE

The generator has been shipped without engine oil. Do not start the engine till fill with the sufficient engine oil.

- 1、 Place the generator on a level surface.
- 2、 Remove the screws① and then remove the cover②.
- 3、 Remove the oil filler cap③.
- 4、 Fill the specified amount of the recommended engine oil, and then install and tighten the oil filler cap.
- 5、 Install the cover and tighten the screws.

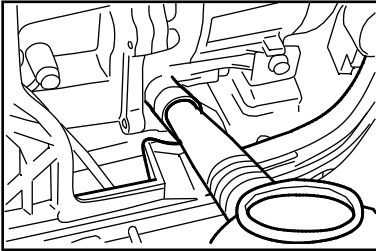
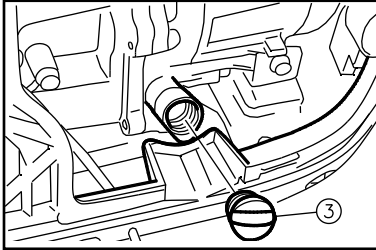
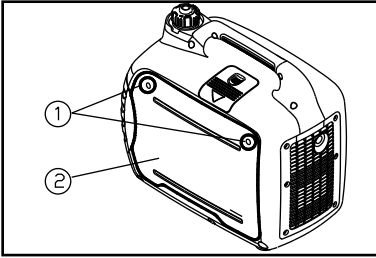

Recommended engine oil:

SAE 10W -30

Recommended engine oil grade:

API Service SE type or higher

Engine oil quantity:

0.35 L (0.42 US qt, 0.35 Imp qt)

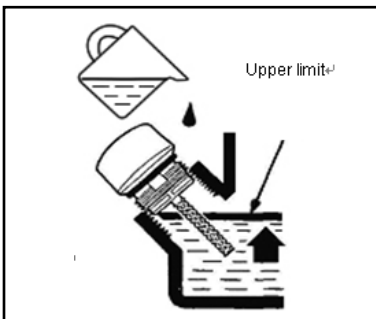

## PRE-OPERATION CHECK

### **⚠ DANGER**

If any item in the Pre-operation check is not working properly, have it inspected and repaired before operating the generator. The condition of a generator is the owner's responsibility. Vital components can start to deteriorate quickly and unexpectedly, even if the generator unused.

**TIP:** Pre-operation checks should be made each time the generator is used.

### **Pre-operation check**

#### **Fuel (See page 18)**

- Check fuel level in fuel tank.
- Refuel if necessary.

#### **Engine oil (See page 19)**

- Check oil level in engine.
- If necessary, add recommended oil to specified level.
- Check generator for oil leakage.

#### **The point where abnormality was recognized by use**

- Check operation.
- If necessary, consult a LONCIN dealer.

## OPERATION

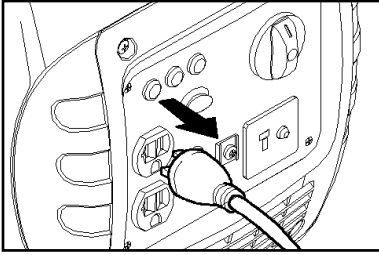

### ⚠ WARNING

- Never operate the engine in a closed area or it may cause unconsciousness and death within a short time. Operate the engine in a well ventilated area.
- Before starting the engine, do not connect any electric devices.

### NOTICE

- The generator has been shipped without engine oil. Do not start the engine till fill with the sufficient engine oil.
- Do not tilt the generator when adding engine oil.  
This could result in overfilling and damage to the engine,

### TIP:

The generator can be used with the rated output load at standard atmospheric conditions.

“Standard atmospheric conditions “

Ambient temperature 25°C

Barometric pressure 100kPa

Relative humidity 30%

The output of the generator varies due to change temperature, altitude(lower air pressure at higher altitude) and humidity.

The output of the generator is reduced when the temperature, the humidity and the altitude are higher than standard atmospheric conditions.

Additionally, the load must be reduced when using in a confined areas, as generator cooling is affected.

## Starting the engine

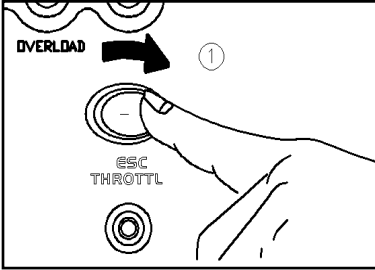

1. Turn the ESC switch to "OFF" ①

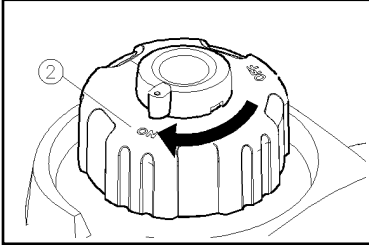

2. Turn the air vent knob to "ON" ②.

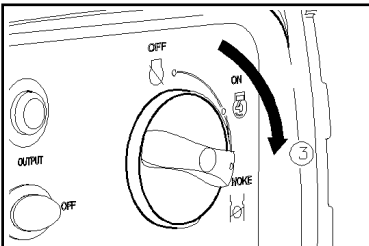

3. Turn the 3 in 1 switch to "CHOCK" ③
  - a. Ignition circuit is switched on.
  - b. Fuel is switched on.
  - c. chock is switched off

**TIP:** The choke is not required to start a warm engine. Push the choke knob in to the position ⑤ "ON".

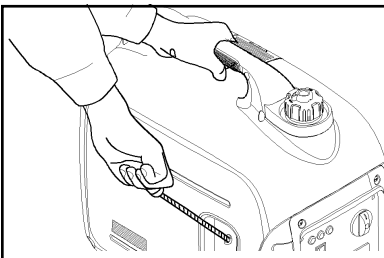

4. Pull slowly on the recoil starter until it is engaged, then pull it briskly.

**TIP:** Grasp the carrying handle firmly to prevent the generator from falling over when pulling the recoil starter.

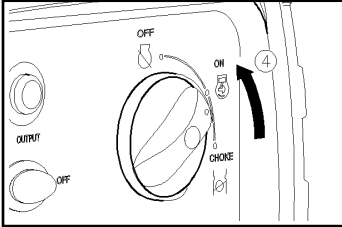

5. After the engine starts, warm up the engine until the engine does not stop when the choke knob is returned to the **5** “ON” position **4**.

**TIP:** When starting the engine, with the ESC “ON”, and there is no load on the generator:

- in ambient temperature below 0°C(32°F), the engine will run at the rated r/min (5000r/min) for 5 minutes to warm up the engine.
- In ambient temperature below 5°C(41°F), the engine will run at the rated r/min (5000r/min) for 3 minutes to warm up the engine.

The ESC unit operates normally after the above time period, while the ESC is “ON”.

## Stopping the engine

**TIP:** Turn off any electric devices.

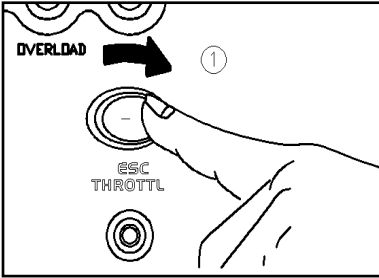

1. Turn the ESC to "OFF" ①

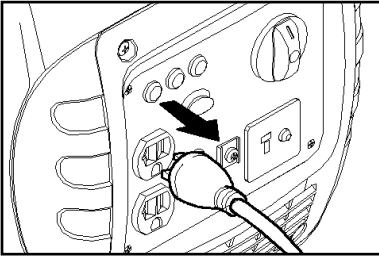

2. Disconnect any electric devices.

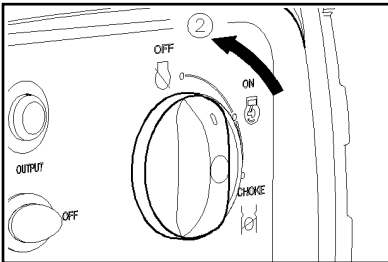

3. Turn the 3 in 1 switch to  "OFF" ②  
a. Ignition circuit is switched off.  
b. Fuel is switched off.

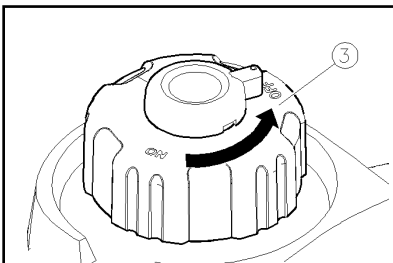

4. Turn the fuel tank cap air vent knob to "OFF",  
③ after the engine has completely cooled down.



## Alternating Current (AC) connection

### WARNING

Be sure any electric devices are turned off before plugging them in.

### NOTICE

- **Be sure all electric devices including the lines and plug connections are in good condition before connection to the generator.**
- **Be sure the total load is within generator rated output.**
- **Be sure the receptacle load current is within receptacle rated current.**

**TIP:** Make sure to ground (Earth) the generator.

When the electric device is earthed, always the generator must be earthed.

1. Start the engine.
2. Turn the ESC to “ON”.
3. Plug in to AC receptacle.
4. Make sure the AC pilot light is on.
5. Turn on any electric devices

**TIP:** The ESC must be turned to “OFF” to increase engine speed to rated rpm. If the generator is connected to multiple loads or electricity consumers, please remember to first connect the one with the highest starting current.. and last connect the one with the lowest starting current.

## Battery Charging

### TIP

- The generator DC rated voltage is 12V.
  - Start the engine first, and then connect the generator to the battery for charging.
  - Before starting to charge the battery, make sure that the DC protector is turned on.
1. Start the engine.
  2. Connect the red battery charger lead to the positive (+) battery terminal.

3. Connect the black battery charger lead to the negative (-) battery terminal.
4. Turn the ESC “off” to start battery charging.

## NOTICE

- Be sure the ESC is turned off while charging the battery.
- Be sure to connect the red battery charger lead to the positive (+) battery terminal, and connect the black lead to the negative (-) battery terminal. Do not reverse these positions.
- Connect the battery charger leads to the battery terminals securely so that they are not disconnected due to engine vibration or other disturbances.
- Charge the battery in the correct procedure by following instructions in the owner’s manual for the battery.
- The DC protector turns off automatically if current above the rated flows during battery harging. To restart charging the battery, turn he DC protector on by pressing its button to “ON”. If the DC protector turns off again, top charging the battery immediately and consult a LONCIN dealer.

## TIP

- Follow instructions in the owner’s manual for the battery to determine the end of battery charging.
- Measure the specific gravity of electrolyte to determine if the battery is fully charged. At full charge, the elecroyte specific gravity is between 1.26 and 1.28.
- It is advisable to check the specific gravity of the electrolyte at least once every hour to prevent overcharging the battery.

## WARNING

**Never smoke or make and break connections at the battery while charging. Sparks may ignite the battery gas.**

**Battery electrolyte is poisonous and dangerous, causing severe burns, etc. contains sulfuric (sulphuric) acid. Avoid contact with skin, eyes or clothing.**

**Antidote:**

**EXTERNAL- Flush with water.**

**INTERNAL- Drink large quantities of water or milk. Follow with milk of magnesia, beaten egg or vegetable oil . Call physician immediately.**

**EYES: Flush with water for 15 minutes and get prompt medical attention.**

**Batteries produce explosive gases. Keep sparks, flame, cigarettes, etc., away. Ventilate when charging or using in closed space. Always cover eyes when working near batteries.**

**KEEP OUT OF REACH OF CHILDREN.**

## AC parallel operation

Before connection an appliance to either generator, make sure that it is in good working order and that its electrical rating does not exceed that of the receptacle.

Most motorized appliances require more than their electrical rating for startup. When an electrical motor is started, the overload indicator (red) may come on. This is normal if the overload indicator (red) goes off within 4 seconds. If the overload indicator (red) stays on, consult your generator dealer.

During parallel operation, the ESC switch should be in the same position on both generator.

1. Connect the parallel operation cable between the LC2000i to either an LC2000i or another LC2000i Companion generator following the instructions supplied with the cable kit.

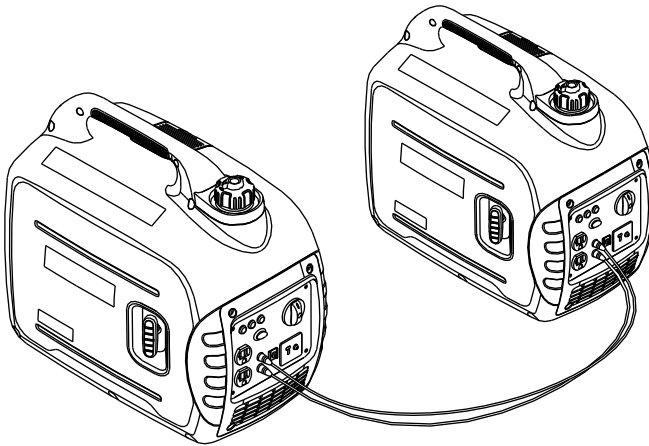

2. Start the engines and make sure the output indicator (green) on each generator comes on .
3. Plug an appliance into the AC receptacle.
4. Turn on the appliance.

If the generator are overload, or if there is a short circuit in a connected appliance, the overload indicator (red) will go ON. The overload indicator (red) will stay ON, and after about 4 seconds, current to the connected appliance(s) will shut off, and the output indicator (green) will go OFF. Stop both engines and investigate the problem. Determine if the cause is a short circuit in a connected appliance or an overload, Correct the problem and restart the generator.

## AC Parallel Operation Applications

Both types of LC2000i generators (Standard and Companion )can be connected to each other to increase the available power using a parallel cable kit .

Follow the instructions included with the parallel operation cable kit. Before connection an appliance or power cord to the generator;

### TIP

- Make sure that it is in good working order. A faulty appliance or power cord can create a potential for electrical shock.
- If an appliance begins to operate abnormally, becomes sluggish, or stops suddenly, turn it off immediately. Disconnect the appliance and determine whether the problem is the appliance, and determine whether the problem is the appliance or the rated load capacity of the generator has been exceeded.
- Make sure that the combined electrical rating of the tools or appliance do not exceed that of the generator. Never exceed the maximum may be used for no more than 30 minutes. Never connect different generator models.
- For parallel operation, use only a LONCIN approved parallel operation cable kit then connecting one LC2000i Companion to either an LC2000i or another LC2000i Companion generator.
- Never connect or remove the parallel operation cable when the generator is running.
- For single generator operation, the parallel operation cable must be removed.

### WARNING

Substantial overloading that continuously lights the overload indicator (red) may damage the generator. Marginal overloading that temporarily lights the overload indicator (red) may shorten the service life of the generator.

Limit operation requiring maximum power to 30 minutes.

Maximum power in parallel operation is; 4.0kVA .





For continuous operation, do not exceed the rated power.

Rated power in parallel operation is: 3.2kVA .

The total power requirements (VA) of all appliances connected must be considered. Appliance and power tool manufacturers usually list rating information near the model number or serial number.

## Application range

When using the generator, make sure the total load is within rated output of a generator. Otherwise, generator damage may occur

AC				DC 
Power factor	1	0.8-0.95	0.4-0.75 (Efficiency 0.85)	
LC2000i	~1,600W	~1,280W	~544W	Rated voltage 12V Rated current 8.3A

### TIP

- “~” means below.
- Application wattage indicates when each device is used by itself.
- The simultaneous usage of AC and DC power is possible but total wattage should not exceed the rated output.

EX:

Generator rated output		1,600VA
Frequency	Power factor	
AC	1.0	~1,600W
	0.8	~1,280W
DC	---	100W (12V/8.3A)

The overload indicator light ① comes on when total wattage exceeds the application range. (See page 14 for more details.)

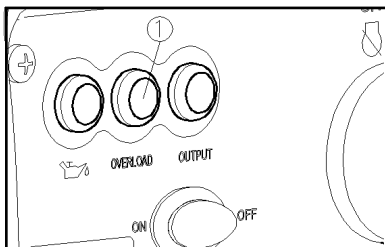

## NOTICE

- Do not overload. The total load of all electrical appliances must not exceed the supply range of the generator. Overloading will damage the generator.
- When supplying precision equipment, electronic controllers, PCs, Electronic computers, microcomputer based equipment or battery chargers, keep the generator a sufficient distance away to prevent electrical interference from the engine. Also ensure that electrical noise from the engine does not interfere with any other electrical devices located near the generator.
- If the generator is to supply medical equipment, advice should first be obtained from the manufacturer, a medical professional or hospital.
- Some electrical appliances or general-purpose electric motors have High starting currents, and cannot therefore be used, even if they lie within the supply ranges given in the above table. Consult the equipment manufacturer for further advice.

# PERIODIC MAINTENANCE

Safety is an obligation of the owner. Periodic inspection, adjustment and lubrication will keep your generator in the safest and most efficient condition possible. The most important points of generator inspection, and lubrication are explained on the following pages.

**⚠ WARNING**

If you are not familiar with maintenance work, have a LONCIN dealer do it for you

## Maintenance chart

**⚠ WARNING**

Stop the engine before starting maintenance work.

**NOTICE**

Use only LONCIN specified genuine parts for replacement. Ask an authorized LONCIN dealer for further attention.

Item	Routine	Preoper ation check	Every	
			6 months or 100 Hr	12 month s or 300 Hr
Spark plug	<ul style="list-style-type: none"> <li>· Check condition.</li> <li>· Clean and replace if necessary.</li> </ul>		○	
Fuel	<ul style="list-style-type: none"> <li>· Check fuel level and leakage.</li> </ul>	○		
Fuel hose	<ul style="list-style-type: none"> <li>· Check fuel hose for cracks or damage.</li> <li>· Replace if necessary.</li> </ul>	○		
Engine oil	<ul style="list-style-type: none"> <li>· Check oil level in engine</li> </ul>	○		
	<ul style="list-style-type: none"> <li>· Replace</li> </ul>		○(*1)	
Air filter Element	<ul style="list-style-type: none"> <li>· Check condition.</li> <li>· Clean.</li> </ul>		○(*2)	

Muffler screen	<ul style="list-style-type: none"> <li>· Check condition.</li> <li>· Clean and replace if necessary.</li> </ul>		○	
Spark arrester	<ul style="list-style-type: none"> <li>· Check condition.</li> <li>· Clean and replace if necessary.</li> </ul>		○	
Fuel filter	<ul style="list-style-type: none"> <li>· Clean and replace if necessary.</li> </ul>			○
Crankcase breather hose	<ul style="list-style-type: none"> <li>· Check breather hose for cracks or damage.</li> <li>· Replace if necessary</li> </ul>			○
Cylinder head	<ul style="list-style-type: none"> <li>· Decarbonize cylinder head</li> <li>· More frequently if necessary</li> </ul>			★
Valve clearance	<ul style="list-style-type: none"> <li>· Check and adjust when engine is cold.</li> </ul>			★
Fittings/ fasteners	<ul style="list-style-type: none"> <li>· Check all fittings and fasteners.</li> <li>· Correct if necessary.</li> </ul>			★
The point where abnormality was recognized by use			○	

\*1.....Initial replacement of the engine oil is after one month or 20 hours of operation.

\*2.....The air filter element needs to be cleaned more frequently when using in unusually wet or dusty areas.

★.....Since these items require tools, date and technical skills, have a LOOCIN dealer perform the service.



## Spark plug inspection

The spark plug is important engine components, which should be checked periodically.

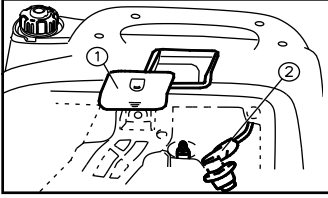

1. Remove the cap ① and spark plug cap ②, and Insert the tool ④ through the hole from the outside of the cover.

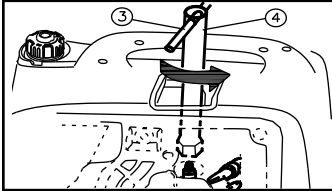

2. Insert the handlebar ③ into the tool ④ and turn it counterclockwise to remove the spark plug.
3. Check for discoloration and remove the carbon. The porcelain insulator around the center electrode of spark plug should be a medium-to-light tan color.

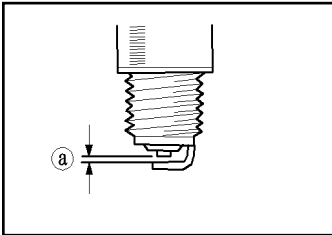

4. Check the spark plug type and gap.

Standard Spark Plug:

E6TC/E6RTC

BP6HS / BPR6HS (NGK)

L87YC / R L87YC (CHAMPION)

W16FP / W16FPR (DENSO)

W6BC / WR6BC (BOSCH)

If need EMC Certification, engine

must use E6RTC spark plug

Spark Plug Gap:

0.6-0.7mm (0.024-0.028in)

### TIP

The spark plug gap should be measured with a wire thickness gauge and, If necessary, to adjusted specification.

5. Install the spark plug.

Spark Plug Torque:

20.0 N\*m (2.0kgf\*m, 14.8 lbf\*ft)

## TIP

If a torque wrench is not available when installing a spark plug, a good estimate of the correct torque is 1/4-1/2 turn past finger tight. However, the spark plug should be tightened to the specified torque as soon as possible.

6. Install the spark plug cap and spark plug cover.

## Carburetor adjustment

The carburetor is a vital part of the engine. Adjusting should be left to a LONCIN dealer with the professional knowledge, specialized date, and equipment to do so properly.

## Engine oil replacement

### **⚠ WARNING**

**Avoid draining the engine oil immediately after stopping the engine. The oil is hot and should be handled with care to avoid burns.**

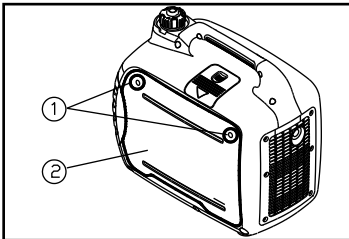

1. Place the generator on a level surface and warm up the engine for several minutes. Stop the engine and turn the 3 in 1 switch knob, fuel tank cap air vent knob to "OFF".

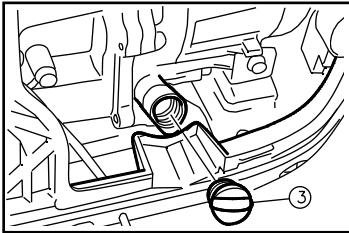

2. Remove the screws ① and then remove the cover ②.

3. Remove the oil filler cap ③.

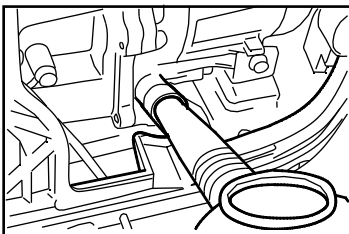

4. Place an oil pan under the engine. Tilt the generator to drain the oil completely.

5. Replace the generator on a level surface.

## NOTICE

**Do not tilt the generator when adding engine oil. This could result in overfilling and damage to the engine.**

6. Add engine oil to the upper level.

Recommended engine oil:  
SAE 10W -30  
Recommended engine oil grade:  
API Service SE type or higher  
Engine oil quantity:  
0.35 L (0.42 US qt, 0.35 Imp qt)

7. Wipe the cover clean, and wipe up any spilled oil.

## NOTICE

**Be sure no foreign material enters the crankcase.**

8. Install the oil filler cap.  
9. Install the cover and tighten the screws.

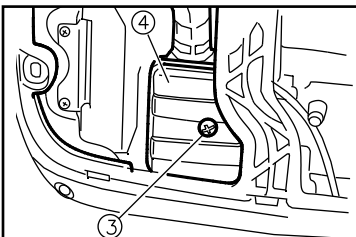
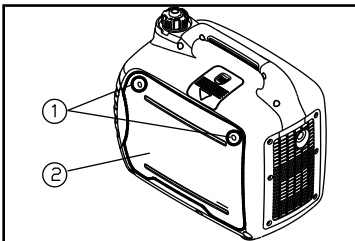

## Air filter

1. Remove the screws ①, and then remove the cover ②

2. Remove the screw ③ and then remove the air filter case cover ④

3. Remove the foam element □.

4. Wash the foam element in solvent and dry it.

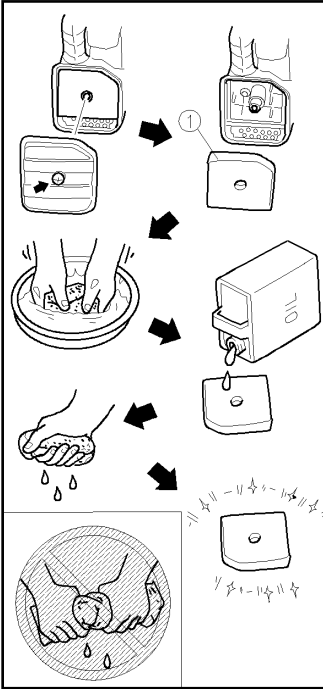

5. Oil the foam element and squeeze out excess oil. The foam element should be wet but not dripping.

### NOTICE

**Do not wring out the foam element when squeezing it. This could cause it to tear.**

6. Insert the foam element into the air filter case.

### TIP

Be sure the foam element sealing surface matches the air filter so there is no air leak.

**The engine should never run without the foam element; excessive piston and cylinder wear may result.**

7. Install the air filter case cover in its original position and tighten the screw.

8. Install the cover and tighten the screws.

## Muffler screen and spark arrester

### ⚠ WARNING

**The engine and muffler will be very hot after the engine has been run. Avoid touching the engine and muffler while they are still hot with any part of your body or clothing during inspection or repair.**

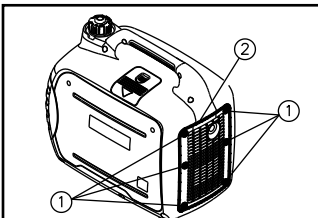

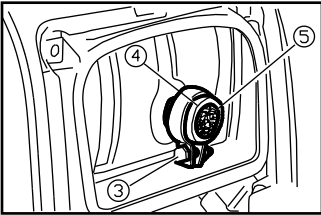

1. Remove the screws ① and then pull outward on the areas of the cover ② shown.

2. Loosen the bolt ③ and then remove the muffler cap ④, the muffler screen ⑤ and spark arrester ⑥.

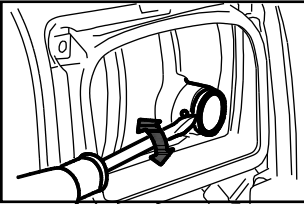

3. Clean the carbon deposits on the muffler screen and spark arrester using a wire brush.

## NOTICE

**When cleaning, use the wire brush lightly to avoid damaging or scratching of muffler screen and spark arrester.**

4. Check the muffler screen and spark arrester. Replace them if damaged.

5. Install the spark arrester.

## ⚠ WARNING

Never use an engine without an appropriate spark arrester in the forest areas! Doing so may cause a fire!

## TIP

Align the spark arrester projection ⑦ with the hole ⑧ in the muffler pipe.

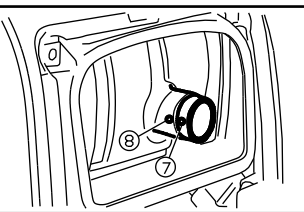
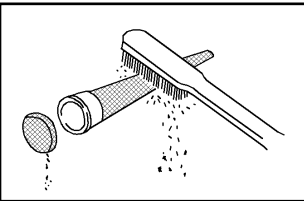
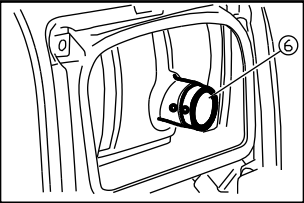

6. Install the muffler screen and the muffler cap.

7. Install the cover and tighten the screws.

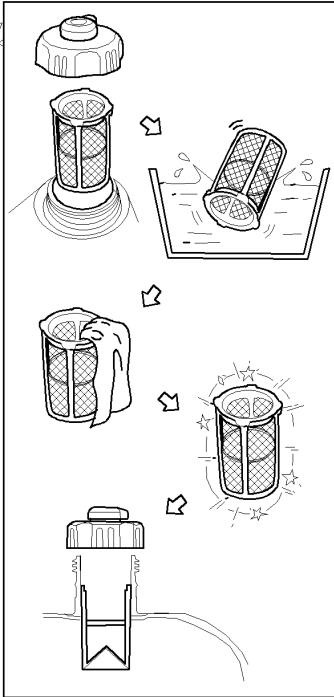

## Fuel tank filter

### **⚠ WARNING**

**Never use the gasoline while smoking or in the vicinity of an open flame.**

1. Remove the fuel tank cap and filter.
2. Clean the filter with gasoline.
3. Wipe the filter and install it.
4. Install the fuel tank cap.

**Be sure the fuel tank cap is tightened securely.**

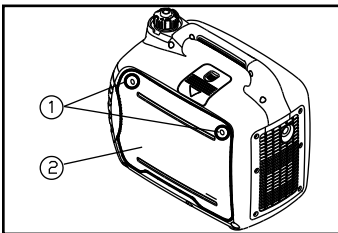

## Fuel filter

1. Remove the screws①, and then remove the cover②, and drain the fuel③.

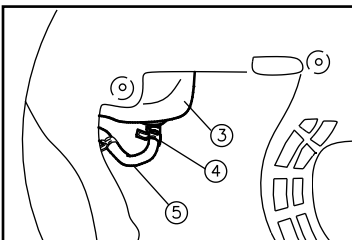

2. Hold and move up the clamp④, then take off the hose⑤ from the tank

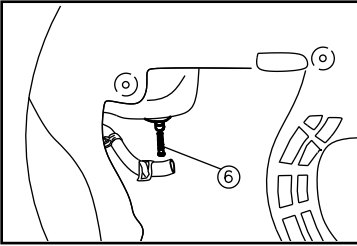

3. Take out the fuel filter⑥

4. Clean the filter with gasoline
5. Dry the filter and put it bank into tank
6. Install the hose and clamp, then open the fuel valve to check whether it is leak
7. Install the cover and tighten the screws.

## STORAGE

Long term storage of your machine will require some preventive procedures to guard against deterioration.

### Drain the fuel

1. Turn the 3 in 1 switch to "OFF" ①
2. Remove the fuel tank cap, remove the filter . Extract the fuel from the fuel tank into an approved gasoline container using a commercially available handsiphon. Then, install the fuel tank cap.

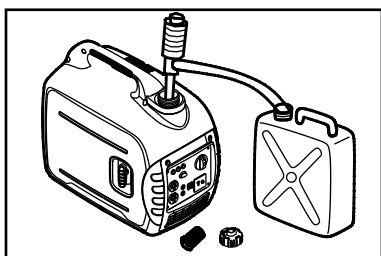
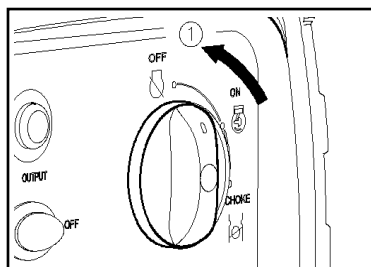

### **⚠ WARNING**

**Fuel is highly flammable and poisonous. Check "SAFETY INFORMATION" (See page 1) carefully.**

### **NOTICE**

**Immediately wipe off spilled fuel with a clean, dry, soft cloth, since fuel may deteriorate painted surfaces or plastic parts.**

3. Start the engine ( See Page 18 ) and leave it run until it stops. The engine stops in approx. 20 mins. Time by running out of fuel.

### **TIP**

- Do not connect with any electrical devices. (unloaded operation)
  - Duration of the running engine depends on the amount of the fuel left in the tank.
4. Remove the screws, and then remove the cover.
  5. Drain the fuel from the carburetor by loosening the drain screw on the carburetor float chamber.



6. Turn the 3 in 1 switch to “OFF”.
7. Tighten the drain screw
8. Install the cover and tighten the screws.
9. Turn the fuel tank cap air vent knob to “OFF” after the engine has completely cools down.

## **Engine**

Perform the following steps to protect the cylinder, piston ring, etc. from corrosion.

1. Remove the spark plug, pour about one table- spoon of SAE 10W-30 into the spark plug hole and reinstall the spark plug. Recoil start the engine by turning over several times (with 3 in 1 switch knob off) to coat the cylinder walls with oil.
2. Pull the recoil starter until you feel compression. Then stop pulling. (This prevents the cylinder and valves from rusting).
3. Clean exterior of the generator. Store the generator in a dry, well-ventilated place, with the cover placed over it.

## TROUBLESHOOTING

### Engine won't start

#### 1. Fuel systems

No fuel supplied to combustion chamber.

- No fuel in tank...Supply fuel.
- Fuel in tank....Fuel tank cap air vent knob and fuel cock knob to "ON".
- Clogged fuel filter .... Clean fuel filter.
- Clogged carburetor.... Clean carburetor

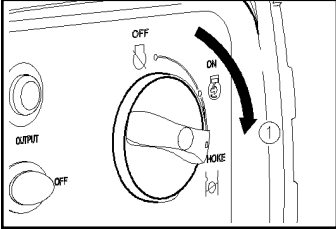
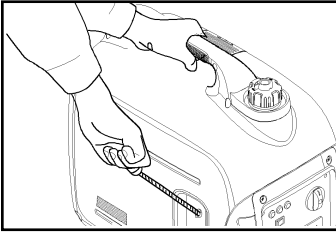

#### 2. Engine oil system

Insufficient

- Oil level is low.... Add engine oil.

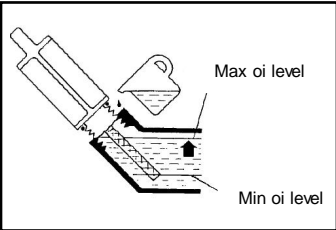

#### 3. Electrical systems

- Put the 1 in 3 switch to "CHOKE" and pull the recoil starter...Poor spark.
- Spark plug dirty with carbon or wet.... Remove carbon or wipe spark plug dry.
- Faulty ignition system.... Consult a LONCIN dealer

### Generator won't produce power

- Safety device (DC protector) to "OFF" .... Press the DC protector to "ON".
- The AC pilot light (Green)go off .... Stop the engine, then restart.

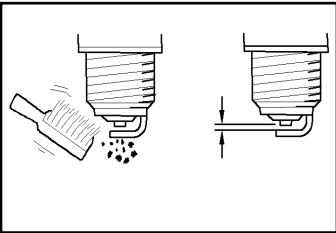

## 11. Parameters

	Model No.	LC2000i
Generator	Type	Inverter
	Rated frequency /Hz	50/60
	Rated voltage /V	230/120
	Max. output power /kVA	1.8
	Rated output power /kVA	1.6
	Power factor	1.0
	AC output quality	ISO8528 G2
	THD /%	≤5
	Noise Level dB/Lpa (3/4 load、7m)	63.5
	DC Output / V-A	12-8.3
	Overload Protect	DC
AC		Control by inverter overload protect program
Engine	Engine	LC148F
	Engine type	Single cylinder, 4-Stroke, forced air cooling, OHV
	Displacement /cc	79
	Fuel type	Unleaded Gasoline
Engine	Fuel tank capacity /L	4.0
	Continue Running Time (at rated	4
	Fuel Tank Capacity /mL	350ml
	Spark Model No.	E6TC/E6RTC
	Starting mode	Recoil starter
Generator set	Length Width Height /mm	499×285×455
	Net weight /kg	21

# 12. WIRING DIAGRAM

## A. 60Hz, 120V Without Parallel Receptacle

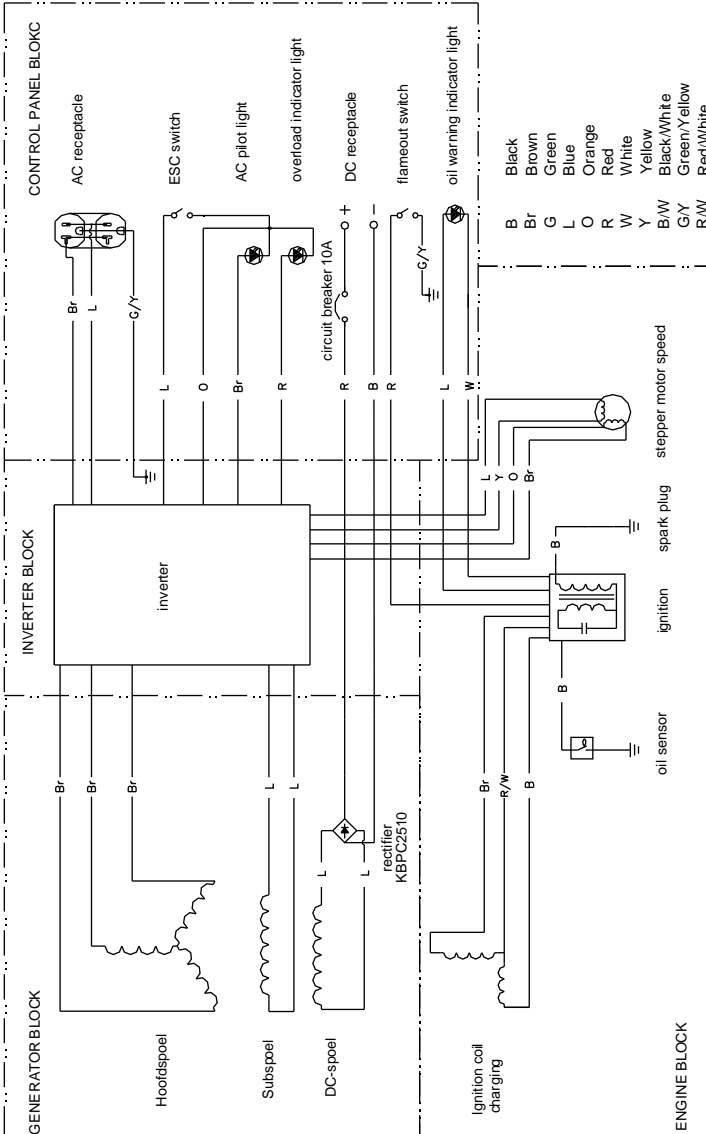

# B.60Hz,120V With Parallel Receptacle

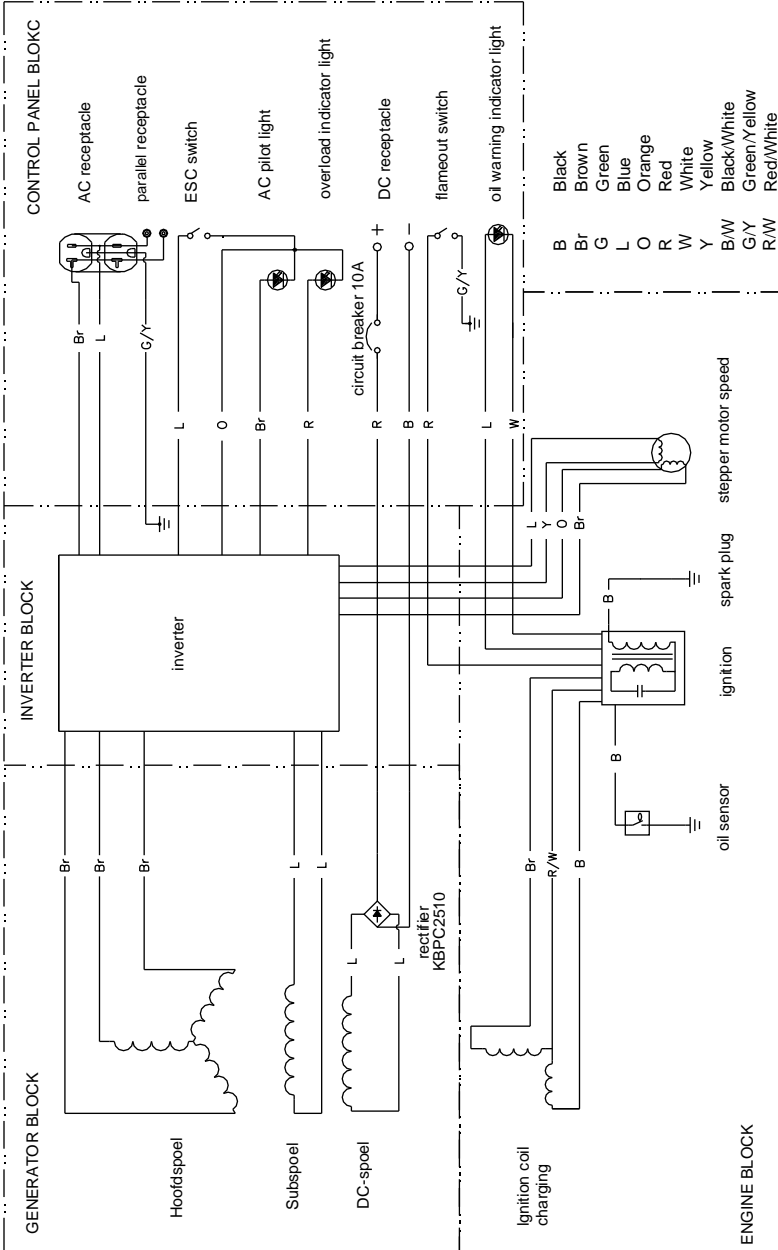

# C.50Hz,230V Without Parallel Receptacle

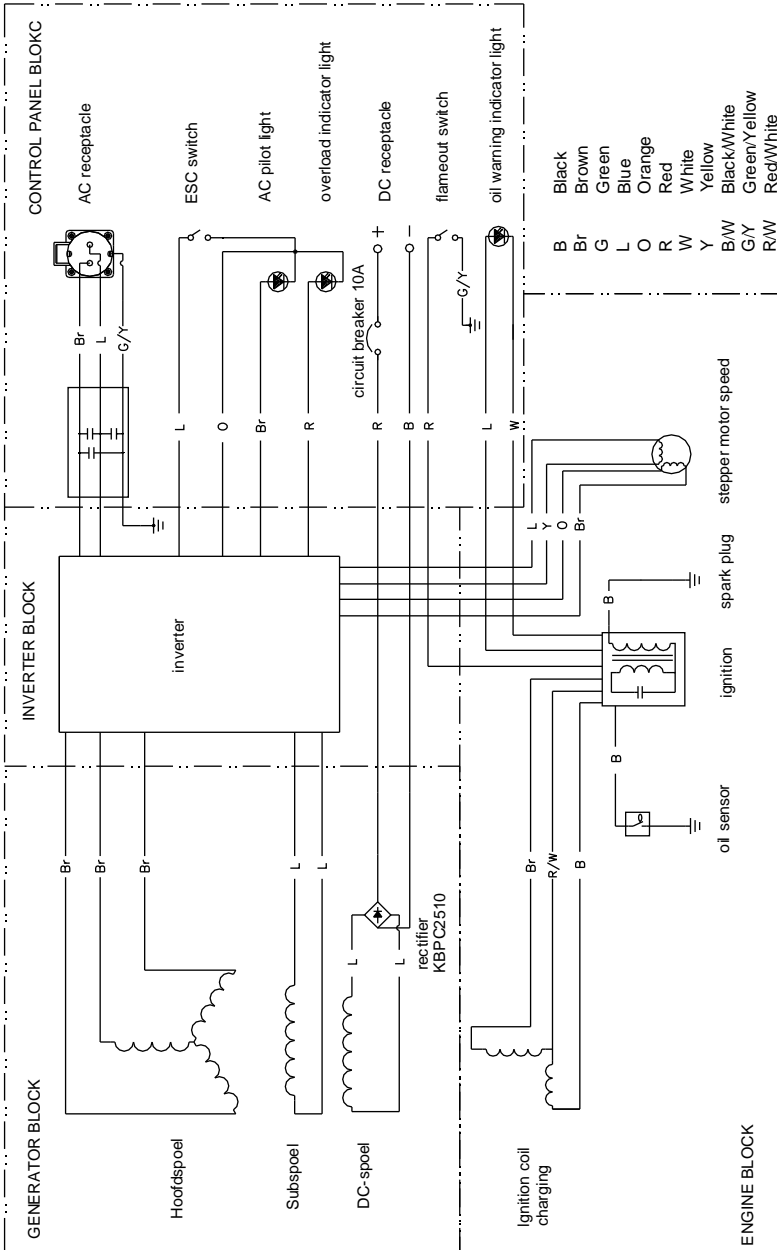

# D.50Hz,230V With Parallel Receptacle

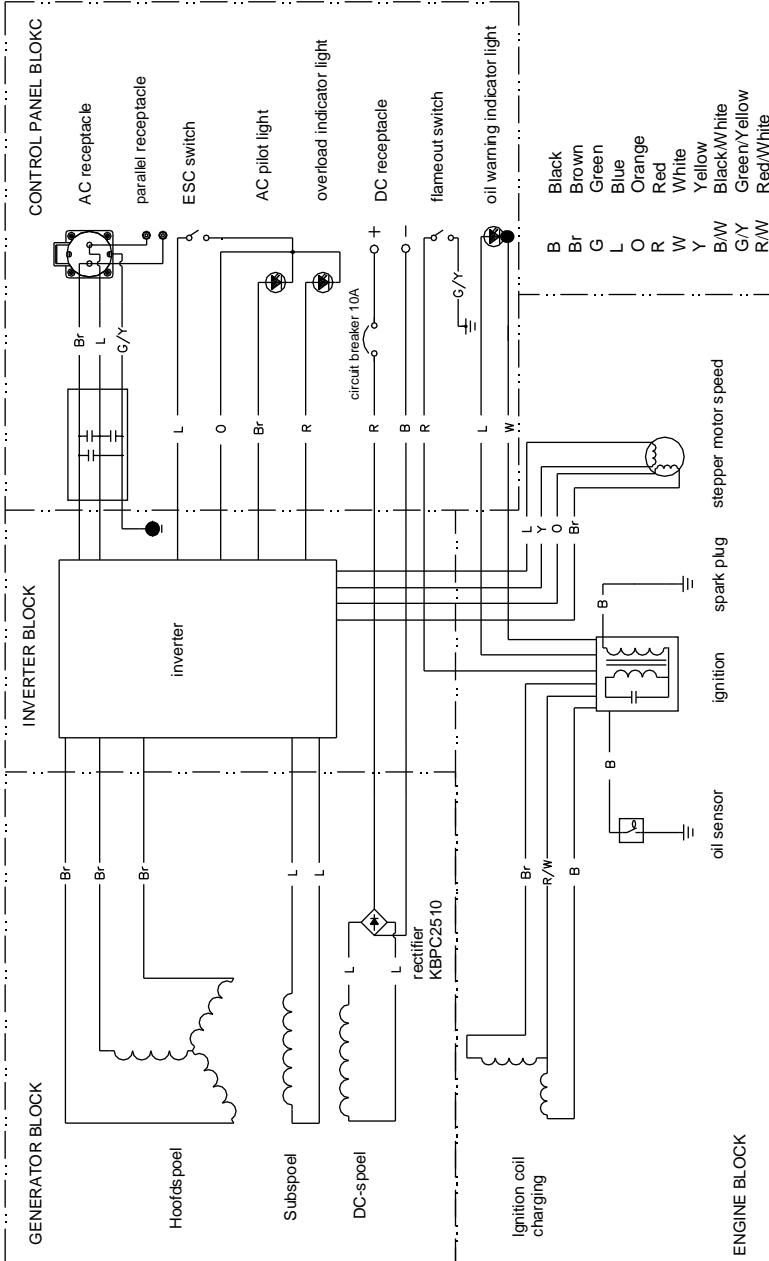

LONCIN MOTOR CO., LTD.

99 Hualong Road, Jiulongpo District, Chongqing, China

PostCode: 400052

Tel: 86 23 8906 7577

Fax: 86 23 8906 7533

Email: [service@loncinengine.com](mailto:service@loncinengine.com)

Web site: [www.loncinengine.com](http://www.loncinengine.com)