



ⓘ Discontinued

Main

Range	TeSys
Product name	TeSys GV7
Device short name	GV7R
Device application	Motor
Poles description	3P
Network type	AC
Utilisation category	AC-3 conforming to IEC 60947-4-1
Network frequency	50/60 Hz conforming to IEC 60947-4-1
Breaking capacity	35 kA Icu at 440 V AC 50/60 Hz conforming to IEC 60947-2 85 kA Icu at 220/240 V AC 50/60 Hz conforming to IEC 60947-2 36 kA Icu at 380/415 V AC 50/60 Hz conforming to IEC 60947-2 25 kA Icu at 500 V AC 50/60 Hz conforming to IEC 60947-2 8 kA Icu at 660/690 V AC 50/60 Hz conforming to IEC 60947-2
[Ics] rated service short-circuit breaking capacity	100 % at 440 V AC 50/60 Hz conforming to IEC 60947-2 100 % at 220/240 V AC 50/60 Hz conforming to IEC 60947-2 100 % at 380/415 V AC 50/60 Hz conforming to IEC 60947-2 50 % at 500 V AC 50/60 Hz conforming to IEC 60947-2 50 % at 660/690 V AC 50/60 Hz conforming to IEC 60947-2
Thermal protection adjustment range	48...80 A
Trip unit technology	Thermal-magnetic

Complementary

Mounting mode	By screws By clips
Mounting support	Kit for fixing the switchgear Rail Panel mounting Flush
Mounting position	Vertical
Motor power kW	37 kW at 400...415 V AC 50/60 Hz 45 kW at 500 V AC 50/60 Hz 55 kW at 500 V AC 50/60 Hz 55 kW at 660...690 V AC 50/60 Hz
Control type	Rocker lever
[Ue] rated operational voltage	690 V AC 50/60 Hz conforming to IEC 60947-2
[Ui] rated insulation voltage	750 V AC 50/60 Hz conforming to IEC 60947-2

[I _{th}] conventional free air thermal current	80 A conforming to IEC 60947-4-1
[U _{imp}] rated impulse withstand voltage	IEC 60947-2 8 kV
Power dissipation per pole	5 W
Power dissipation per pole	5 W
Mechanical durability	50000 cycles
Electrical durability	30000 cycles for AC-3 at 440 V In 50000 cycles for AC-3 at 440 V In/2
Maximum operating rate	25 cyc/h
Rated duty	Continuous conforming to IEC 60947-4-1
Connection pitch	35 mm without spreaders 45 mm with spreaders
Connections - terminals	Bars Cable with lug - external diameter: 10 mm Screw Bare cable connectors 1.5...95 mm ²
Tightening torque	10 N.m on screw M6 screw type 15 N.m on bare cable connectors for cable 1.5...95 mm ²
Mechanical robustness	Shocks: 15 Gn for 11 ms conforming to IEC 60068-2-27 Vibrations: 2.5 Gn, 0...25 Hz conforming to IEC 60068-2-6
Suitability for isolation	Yes conforming to IEC 60947-1
Phase failure sensitivity	Yes conforming to IEC 60947-4-1 § 7-2-1-5-2
Height	161 mm
Width	105 mm
Depth	111 mm
Net weight	2.04 kg

Environment

Standards	VDE 0660 NF C 63-650 EN/IEC 60947-4-1 NF C 63-120 NF C 79-130 VDE 0113 EN/IEC 60947-2 EN/IEC 60947-1
Product certifications	DNV UL
Protective treatment	TC
IP degree of protection	IP405 conforming to IEC 60529 (with terminal shrouds)
Pollution degree	3
Ambient air temperature for operation	-25...70 °C
Ambient air temperature for storage	-55...95 °C
Fire resistance	960 °C conforming to IEC 60695-2-1
Operating altitude	2000 m

Packing Units

Package 1 Weight	1.932 kg
Package 1 Height	14.000 cm
Package 1 width	14.200 cm
Package 1 Length	17.500 cm

Offer Sustainability

EU RoHS Directive	Pro-active compliance (Product out of EU RoHS legal scope) EU RoHS Declaration
Environmental Disclosure	Product Environmental Profile

Contractual warranty

Warranty	18 months
----------	-----------

GV7R

Dimensions

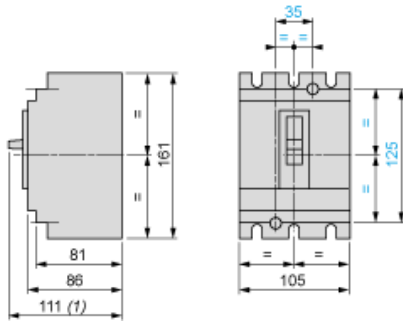

(1) 126 for GV7R.220.

Minimum Electrical Clearance

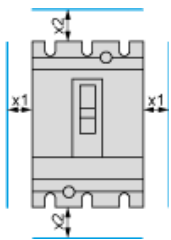

	x1	x2
Painted or insulated metal plate, insulation or insulated bar	0	30
Bare metal plate	$U \leq 440 \text{ V}$	35
	$440 \text{ V} < U < 600 \text{ V}$	35
	$U \geq 600 \text{ V}$	35

GV7R

Panel Mounting

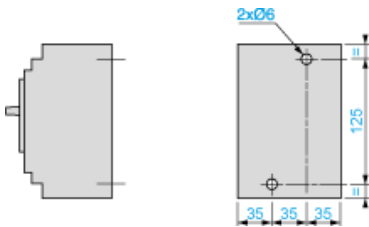

Mounting on 2 Mounting Rails DZ5 MB201

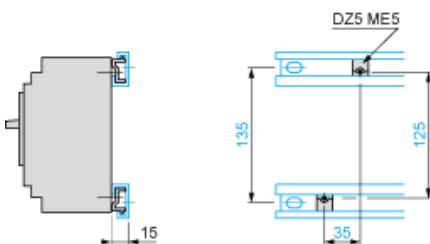

Flush-Mounting

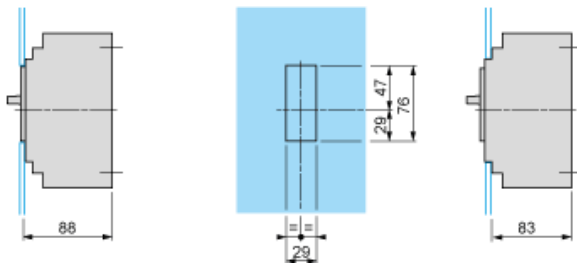

1 circuit breaker GV7R

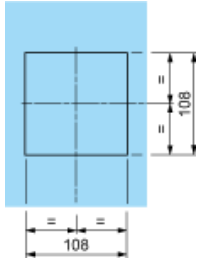

n circuit breakers GV7R side by side

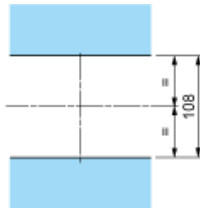

Connection

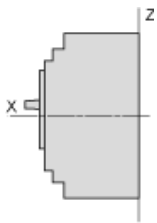

Smooth terminals

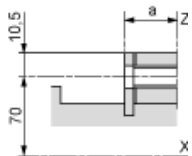

	a
GV7R.40...R.150	19.5
GV7R.220	21.5

Connectors

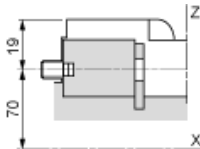

Motor Circuit Breakers

GV7 R

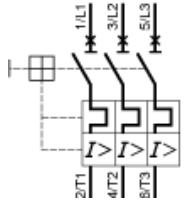

GV7RE80 is replaced by:



Thermal magnetic motor circuit breakers GV4PE80B

Motor circuit breaker, TeSys GV4, 3P, 80A, Icu 25kA, thermal magnetic, Everlink terminals

Qty 1

Reason for Substitution: End of life | Substitution date: 15 April 2019
