

YHL 4 POMPA HELICAL GEAR PUMP

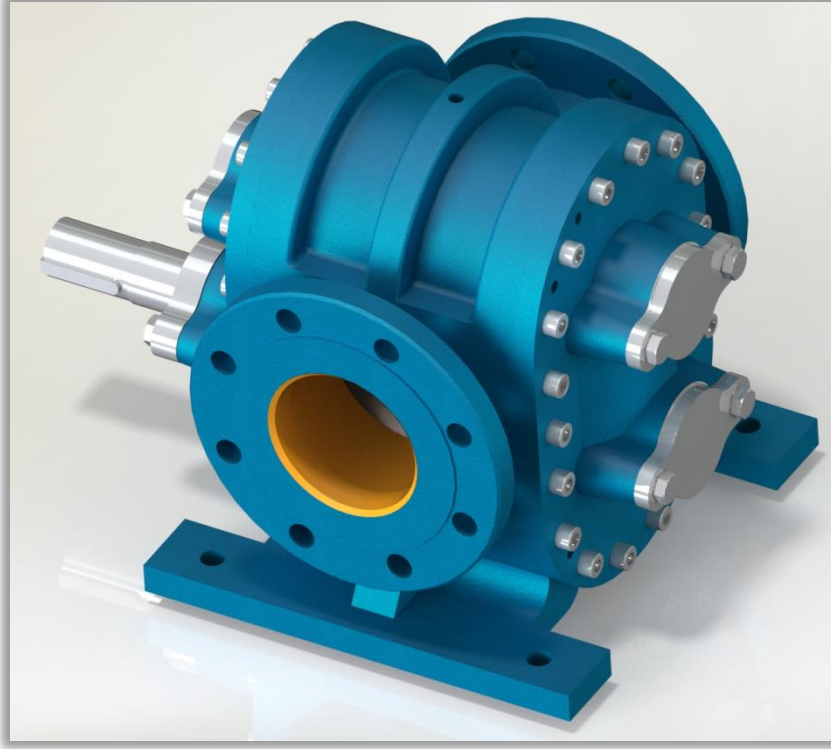
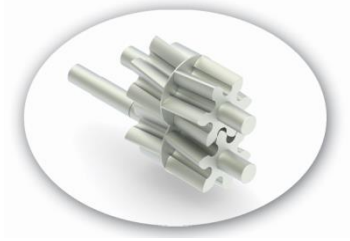

POMPA DEĞERLERİ / PUMP PROPERTIES	
Q	:76 m ³ /h
Hm	:1 ~ 15 Bar
T	:0 ~ 350 °C
n	:1 ~ 450 d/d
Visc.	:100 ~ 250000 SSU

KULLANIM ALANLARI

- Endüstriyel uygulamalarda,
- Melas,
- Petrol,
- Yakıt,
- Yüksek hacim transferlerinde.

USE AREAS

- Industrial applications
- Transfer of molasses,
- Petroleum,
- Fuel,
- High volume transfer

MALZEME SEÇENEKLERİ

- Pompa Gövdesi, Kapaklar, Dişliler :
Dökme (pik) demir, çelik döküm, paslanmaz AISI 304 / 316 döküm, sfero döküm
- Yataklar : Snbz 12 bronz, rulman, karbon grafit, ina burc
- Sızdırmazlık: Yumuşak salmastra, mekanik salmastra.

MATERIAL OPTIONS

- Pump Body, covers and gears: Cast iron, steel cast, stainless AISI 304 / 316 cast.
- Bearings: Snbz 12 bronze, bearing, carbon graphite, Ina bushing bearing.
- Sealing: Soft seal, mechanical seal

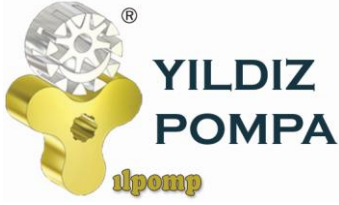

YHL 4 POMPA HELICAL GEAR PUMP



HELİS DİŞLİ POMPA ÇALIŞMA PRENSİBİ / WORKING PRINCIPLE OF HELICAL GEAR PUMP

Bu pompalar da dişli pompa prensibiyle çalışır. Pompa mili, motordan almış olduğu dairesel hareketi, mil üzerindeki dişli (çeviren) ile, diğer dişliye (çevrilen) ters yönde iletir. Dişliler birbirinden ayrılırken, dişlilerin arasına sıvı dolar. Bu sıvı, dönme hareketi ile basma bölgesine taşınarak, dişliler iç içe girerken basma kanalına atılır. Sıvının viskozitesine bağlı olarak 20 Bar'a kadar basınç elde edilir.

Helis dişli olması nedeniyle, sessiz çalışması istenen ve kesintisiz debiye ihtiyaç duyulan yerler için ve fazla koyu olmayan, orta basınçlı ortamlarda kullanılabilir.

These pumps work same gear pumps. Pump shaft transmits circular movement with own gear to other gear on inverse side. While gears leave from other, liquid get full between gears. While gears become close, this liquid moves with rotary motion to outlet. We can have pressure until 20 Bar according to liquid viscose.

Also they are good in where there is a need for uninterrupted capacity for less viscous and medium pressure places.

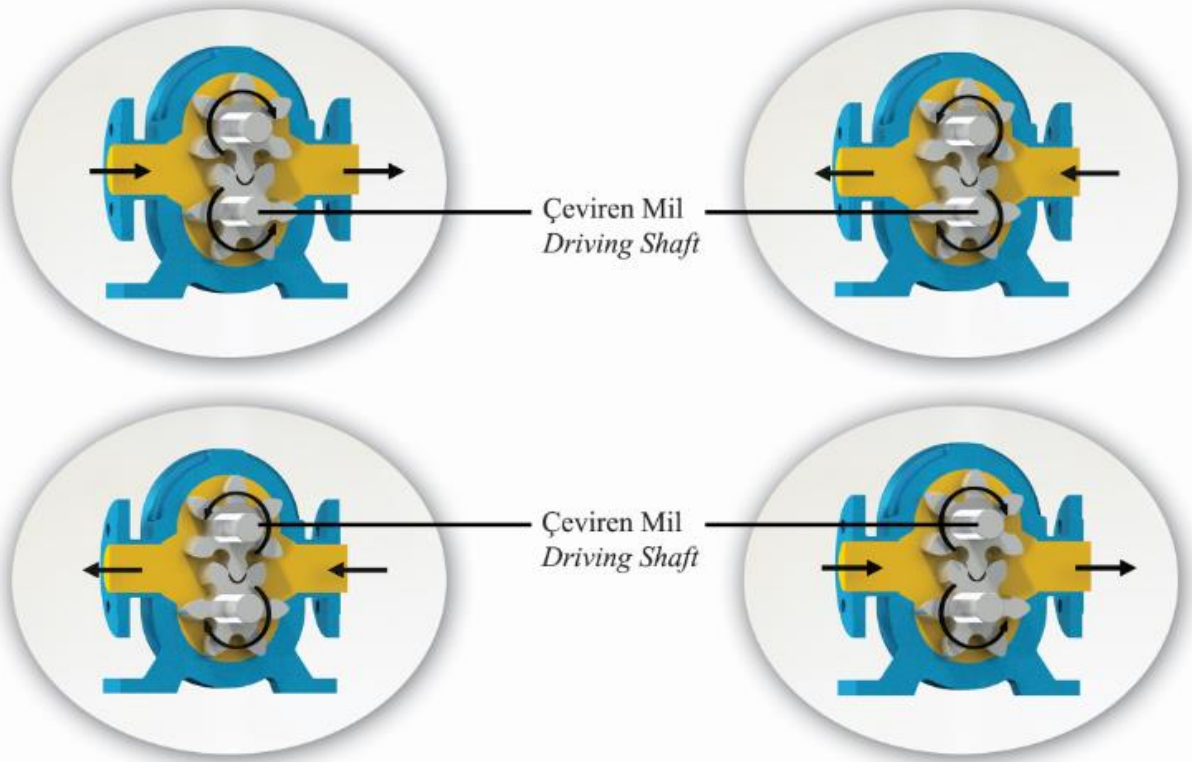

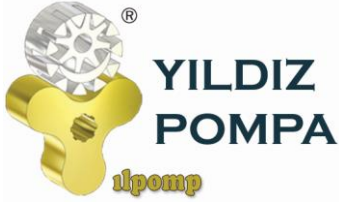

YHL 4 POMPA HELICAL GEAR PUMP

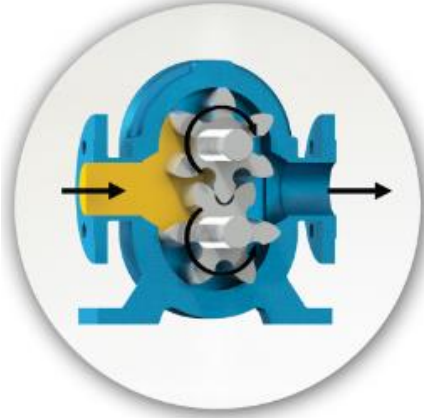
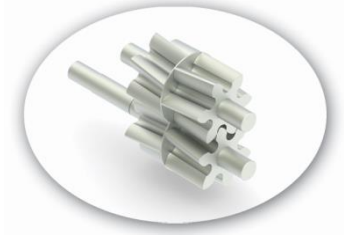

Yandaki renkli kısım sıvının pompa gövdesindeki emiş ağzı alanına, çeviren dişli ve çevrilen dişli dişleri arasındaki dişli boşlukları alanına girişini gösterir. İki siyah ok pompanın dönüş ve sıvının ilerleyişini gösterir.

Picture on the side illustrates the entrance of space between rotating and rotated gears, passing by pump port. Black arrows shows pump's rotation direction and progressing of the liquid inside the pump.

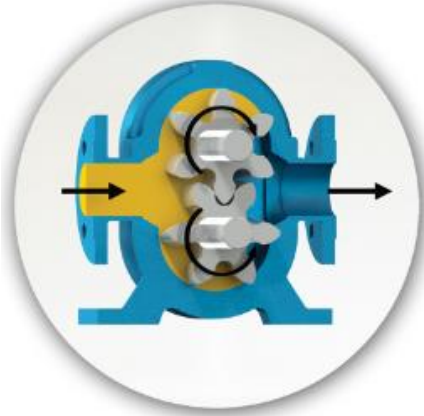

Dişliler ile pompa gövdesi arasında sıvının ilerleyişine dikkat edin. Dişliler birbirlerinin arasında değil, gövde ile dişli boşlukları arasında akışkanı taşımaktadırlar. Bu resim pompanın iç kısmının dolup sıvının boşaltma ağzı alanına itilmesinden hemen önceki durumunu göstermektedir.

Pay attention to liquid progress in the gap between gears' teeth and pump casing. Liquid is transferred not through the gears, but between each gear and pump casing. This picture illustrates the progress of the liquid up to pump discharge area.

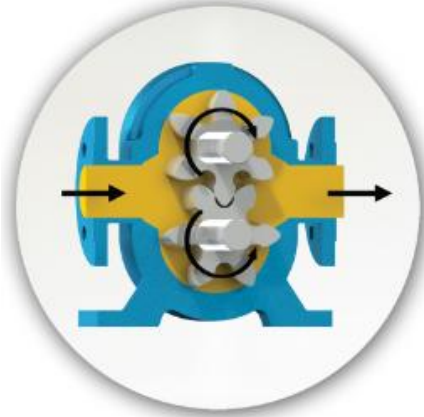

Bu görüntü pompanın tamamen dolup taşıdığı durumu ve sıvının boşaltma işlemini, boşaltma ağzından ilerleyişini göstermektedir. Sıvıyı boşaltma ağzından dışarı doğru iten, çeviren ve çevrilen dişlilerin dişleri birbiri içine geçer.

In this figure, liquid is illustrated during filling all pump inner spaces and flowing out of the pump discharge port. Gears' teeth mesh in and, thus, forces the liquid outside of discharge port.

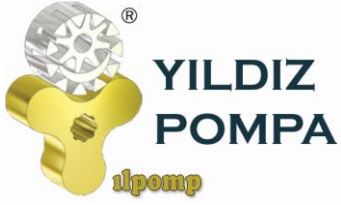

YHL 4 POMPA HELICAL GEAR PUMP

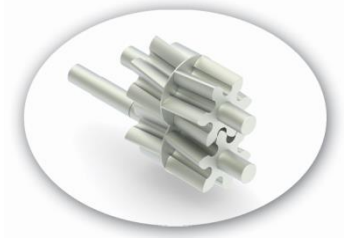

YHL4" POMPASINA AİT KAPASİTE VE GÜÇ TABLOSU / CAPACITY AND POWER TABLE					
KAPASİTE (m ³ /h) CAPACITY (Q)	DEVİR (d/d) SPEED (rpm)	ÇIKIŞ BASINCI / PRESSURE			VİSKOZİTE VISCOSITY
		0 Bar	3,5 Bar	7 Bar	
31	200	15 HP	20 HP	25 HP	25000 SSU
48	300	20 HP	25 HP	30 HP	7500 SSU
68	400	20 HP	25 HP	40 HP	2500 SSU
75	440	20 HP	25 HP	40 HP	750 SSU
78	500	15 HP	20 HP	40 HP	100 SSU

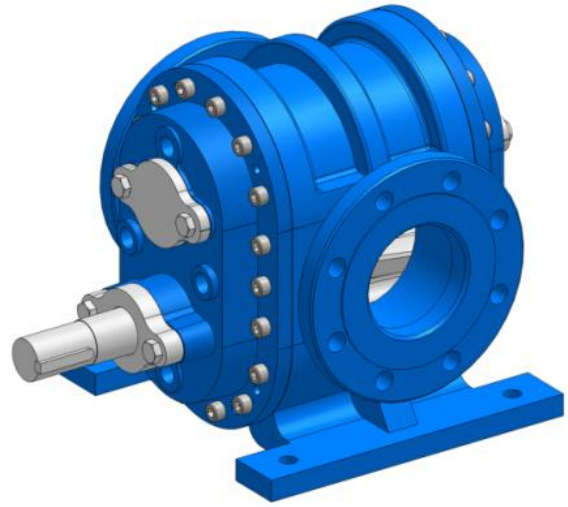
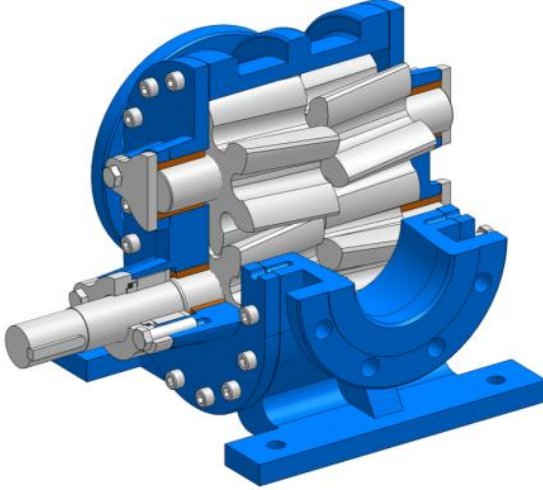

KAPASİTE EĞRİLERİ / CAPACITY GRAPHS

YILDIZ POMPA MAKINA SAN. TIC. LTD. STI. Aydınlı Mh. Birlik Org. San. Böl. 5.Sk. No:7 Tuzla / İSTANBUL
Tel : (0216) 378 64 21



**YILDIZ
POMPA**

ilpomp

YHL 4 POMPA HELICAL GEAR PUMP

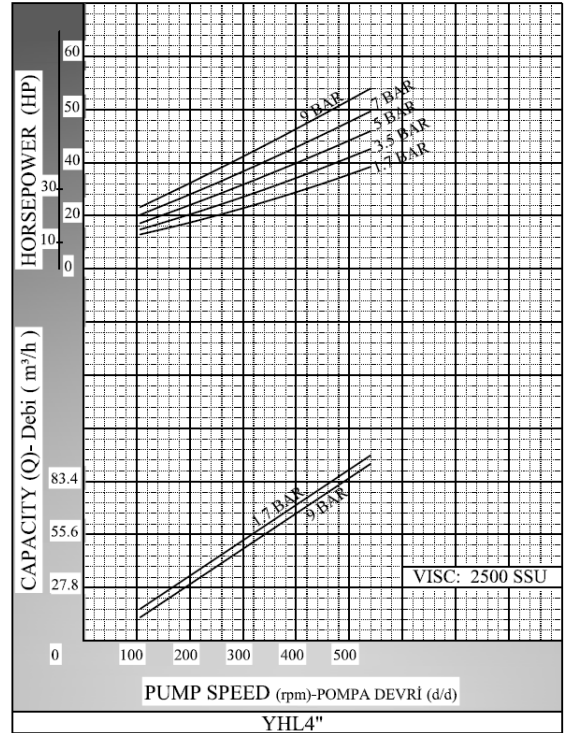
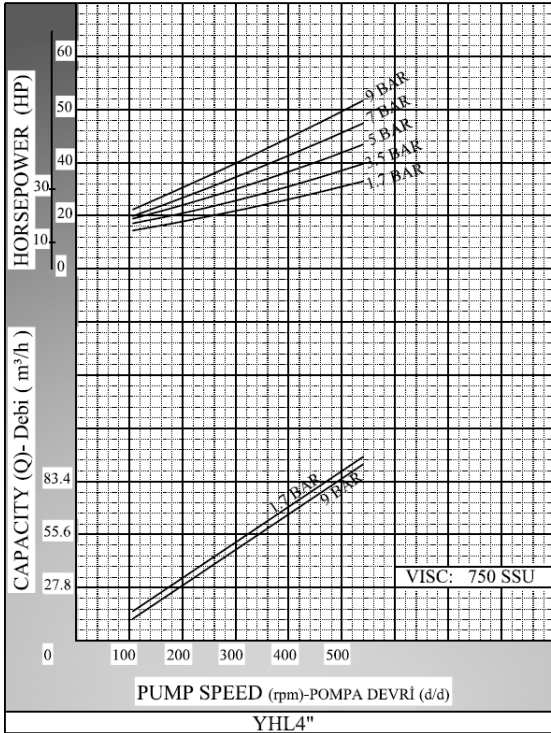
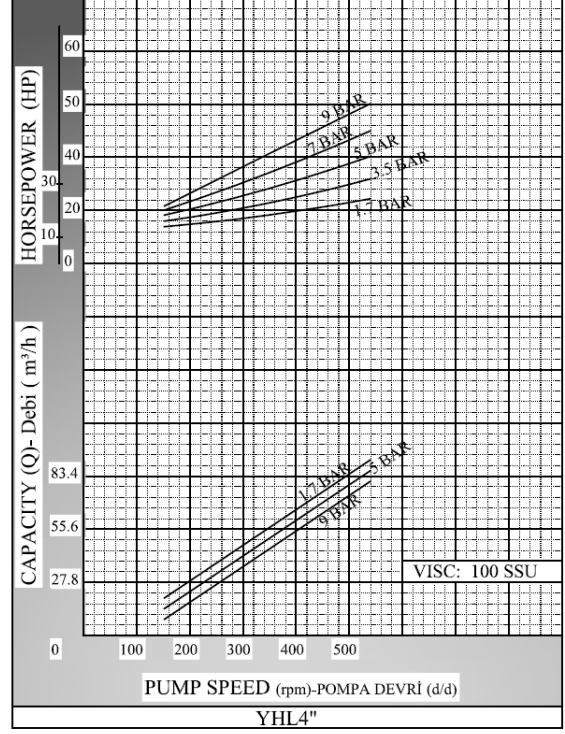
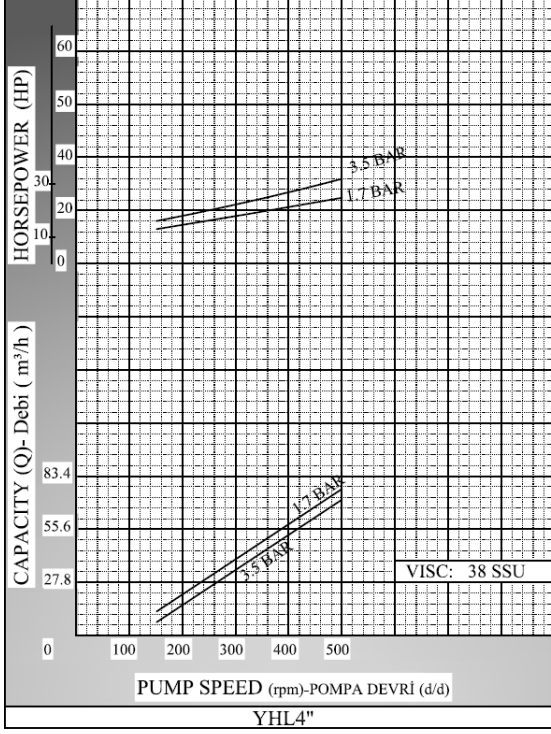
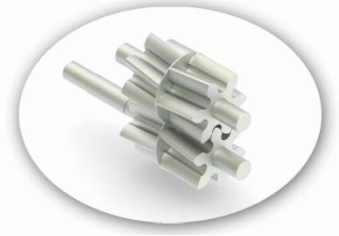



YHL 4 POMPA HELICAL GEAR PUMP

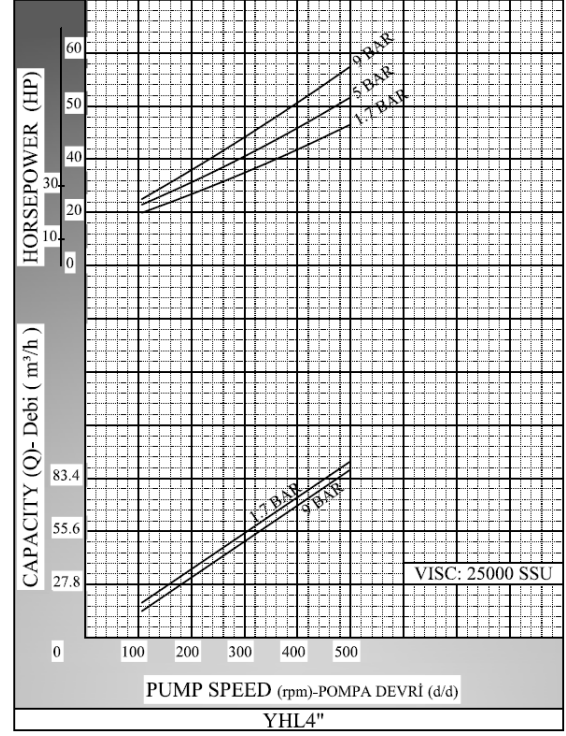
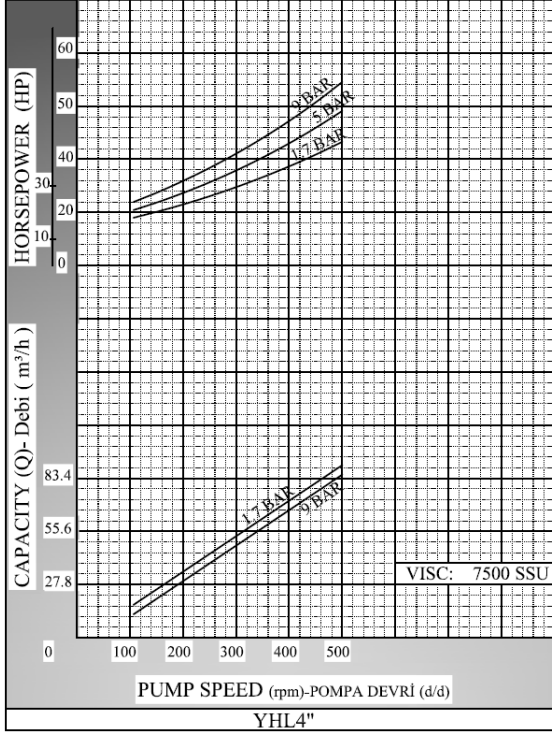
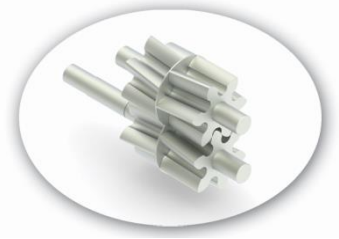

POMPA BOYUT ÖLÇÜLERİ / PUMP DIMENSIONS

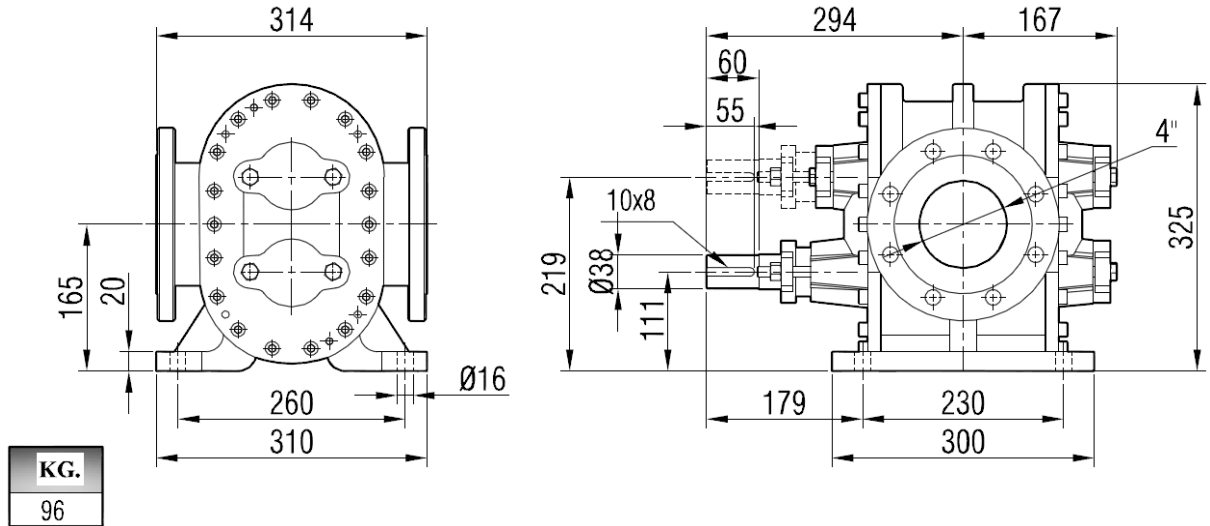

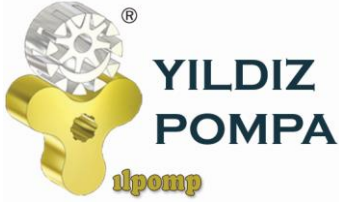

YHL 4 POMPA HELICAL GEAR PUMP



AKUPLAJ ÖLÇÜLERİ / COUPLING DIMENSIONS REDÜKTÖR AKUPLERLİ / GEARBOX DRIVE

YHL 4"

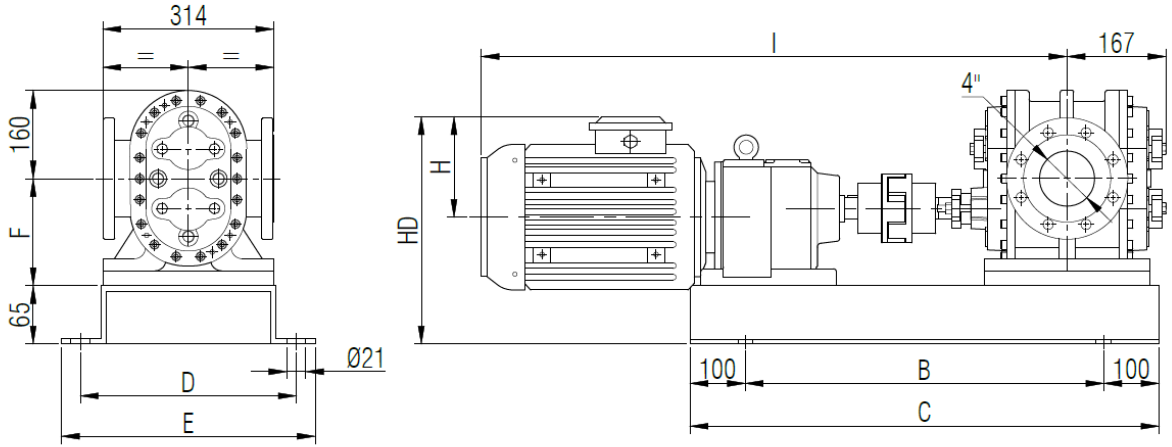

MOTOR GÜÇ VE DEVİRLERİ / MOTOR POWER AND SPEED	I	HD	H	B	C	D	E	F	kg.	
15 hp / 11 kw 205/450 d/d (rpm)	İRAM72/C132M	1064	371	182	680	880	390	430	194	221
20 hp / 15 kw 130/450 d/d (rpm)	İRAM82/160L	1249	457	225	830	1030	450	490	234	357
25 hp / 18,5 kw 180/450 d/d (rpm)	İRAM82/180M	1261	480	248						377
30 hp / 22 kw 260/450 d/d (rpm)	İRAM82/180L	1299								402

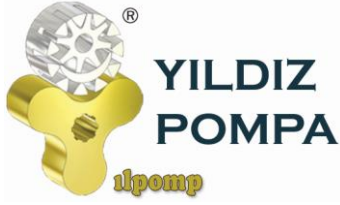

YHL 4 POMPA HELICAL GEAR PUMP

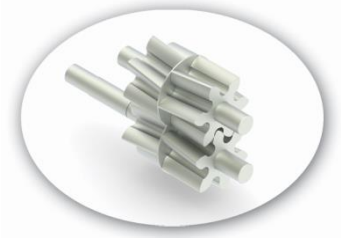

YEDEK PARÇA LİSTESİ / SPARE PARTS LIST YUMUŞAK SALMASTRALI / SEALED WITH SOFT SEAL

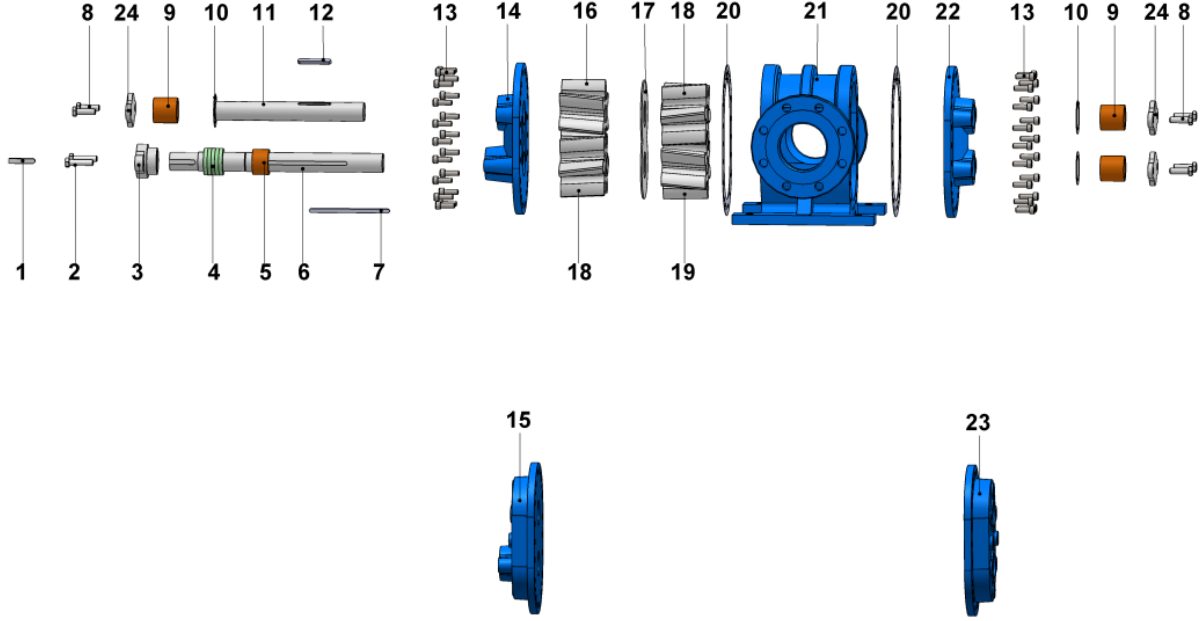

No	PARÇA İSMİ	PART NAME	ADET/ QTY.
1	KAPLİN KAMASI 10x8x55 AB	COUPLING KEY 10x8x55 AB	1
2	M12x50 6 KÖŞELİ CİVATA	HEX BOLT M12x50	2
3	YUMUŞAK SALMASTRA BASKISI	PACKING PRESS	1
4	YUMUŞAK SALMASTRA	SOFT SEAL / PACKING GLAND	1
5	SALMASTRA BURCU	SEAL BUSHING	1
6	UZUN MİL	DRIVING SHAFT	1
7	8x7x170 A UZUN MİL KAMA A	DRIVING SHAFT KEY 8x7x170 A	1
8	M12x40 6 KÖŞELİ CİVATA	HEX BOLT M12x40	6
9	BURÇ	BUSHING	3
10	BURÇ KAPAĞI O-RİNG'İ	BUSHING COVER O-RING	3
11	KISA MİL	DRIVEN SHAFT	1
12	KISA MİL KAMA 8x7x80 A	DRIVEN SHAT KEY 8x7x80 A	1
13	İMBUS CİVATA M10x30	İMBUS BOLT M10x30	36
14	ÖN KAPAK	FRONT COVER	1
15	ÖN CEKETLİ KAPAK	JACKETED FRONT COVER	1
16	KAMASIZ SAĞ HELİS DİŞLİ	RIGHT HELICAL GEAR (without KEY)	1
17	ARA SAC	INTERVAL SHEET METAL	1
18	KAMALI FATURALI SOL HELİS DİŞLİ	LEFT HELICAL GEAR (w/ KEY & SHOULDER)	2
19	KAMALI SAĞ HELİS DİŞLİ	RIGHT HELICAL GEAR (w/ KEY)	1
20	GÖVDE CONTASI	CASING GASKET	2
21	GÖVDE	CASING	1
22	ARKA KAPAK	BACK COVER	1
23	ARKA CEKETLİ KAPAK	JACKETED BACK COVER	1
24	BURÇ KAPAĞI	BUSHING COVER	3

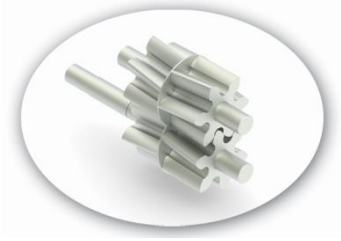

YEDEK PARÇA LİSTESİ / SPARE PARTS LIST
MEKANİK SALMASTRALI / SEALED WITH MECHANICAL SEAL

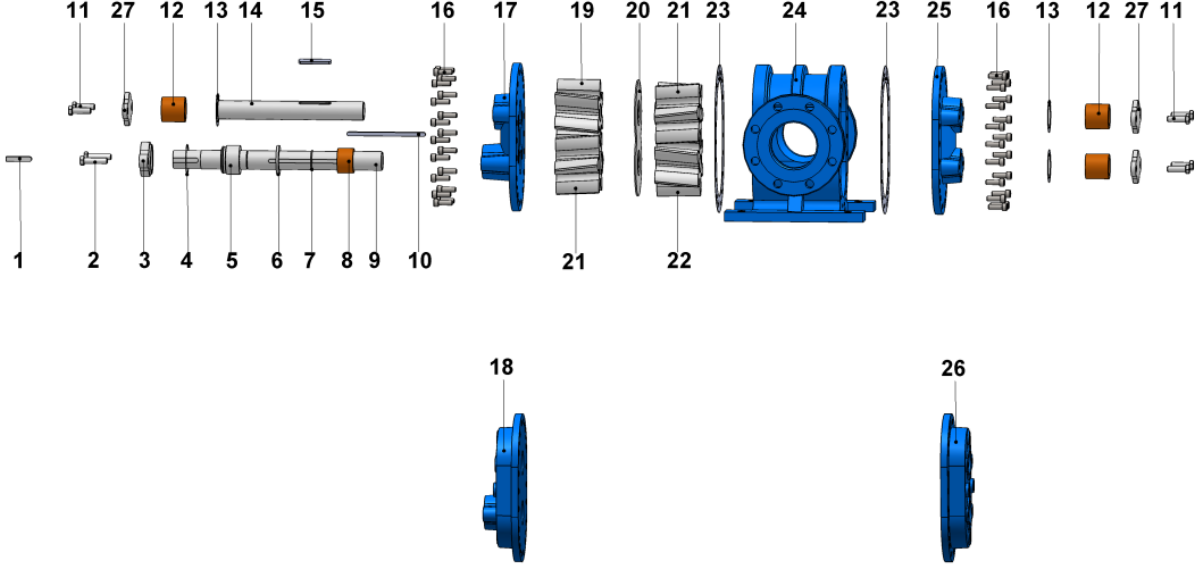

No	PARÇA İSMİ	PART NAME	ADET/ QTY.
1	KAPLİN KAMASI 10x8x55 AB	COUPLING KEY 10x8x55 AB	1
2	M12x50 6 KÖŞELİ CİVATA	HEX BOLT M12x50	2
3	MEKANİK SALMASTRA KAPAĞI	MECHANICAL SEAL COVER	1
4	MEKANİK SALMASTRA KAPAK O-RİNG'İ	MECHANICAL SEAL COVER O-RING	1
5	MEKANİK SALMASTRA	MECHANICAL SEAL	1
6	MEKANİK SALMASTRA PULU	MECHANICAL SEAL WASHER	1
7	40'LIK DIŞ SEGMAN	EXTERNAL CIRCLIP (ø40)	1
8	SALMASTRA BURCU	SEAL BUSHING	1
9	UZUN MİL	DRIVING SHAFT	1
10	8x7x170 A UZUN MİL KAMA A	DRIVING SHAFT KEY 8x7x170 A	1
11	M12x40 6 KÖŞELİ CİVATA	HEX BOLT M12x40	6
12	BURÇ	BUSHING	3
13	BURÇ O-RİNG'İ	BUSHING O-RING	3
14	KISA MİL	DRIVEN SHAFT	1
15	KISA MİL KAMA 8x7x80 A	DRIVEN SHAFT KEY 8x7x80 A	1
16	IMBUS CİVATA M10x30	IMBUS BOLT M10x30	36
17	ÖN KAPAK	FRONT COVER	1
18	ÖN CEKETLİ KAPAK	JACKETED FRONT COVER	1
19	SAĞ HELİS DİŞLİ KAMASIZ	RIGHT HELICAL GEAR (without KEY)	1
20	ARA SAC	INTERVAL SHEET METAL	1
21	KAMALI FATURALI SOL HELİS DİŞLİ	LEFT HELICAL GEAR (w/ KEY & SHOULDER)	2
22	KAMALI SAĞ HELİS DİŞLİ	RIGHT HELICAL GEAR (w/ KEY)	1
23	GÖVDE CONTASI	CASING GASKET	2
24	GÖVDE	CASING	1
25	ARKA KAPAK	BACK COVER	1
26	ARKA CEKETLİ KAPAK	JACKETED BACK COVER	1
27	BURÇ KAPAĞI	BUSHING COVER	3