

MC9 series

Multi-channel Temperature Controller

MANUAL

Thank you very much for purchasing HANYOUNG product.
Please read this manual carefully and keep this for future use.



www.famcocorp.com
E-mail: info@famcocorp.com
@famco_group

Tel: ۰۲۱-۴۸۰۰۰۰۴۹
Fax: ۰۲۱-۴۴۹۹۴۶۴۲

تهران، کیلومتر ۲۱ بزرگراه لشگری (جاده مخصوص کرج)
روبروی پالایشگاه نفت پارس، پلاک ۱۲

Introduction

This user guide is protected by copyright and we have all the rights related to it. Without prior authorization from HANYOUNG, this guide and any parts contained in this guide cannot be reproduced, copied, or translated in other languages.

Contents of this guide will be provided in this form and can be edited or changed without prior noticed.

This guide includes implied guarantee or suitability for a certain purpose, and it does not offer any guarantee for those that do not limit this matter.

Every programs contained in this product is protected by copyright. Without prior authorization from HANYOUNG, this product and any parts contained in this product cannot be reproduced, copied, or translated in another language.

Every title, symbols, figures, service marks, and etc. in this guide or the product are legally registered.

HANYOUNG NUX

#1381-3, Juan 5-dong, Nam-gu, Incheon, Korea

TEL: +82 32 876 4697 FAX: +82 32 876 4696

<http://www.hynux.net>

INDEX

1 Before Starting	1-1. Check Contents	3
	1-2. Safety Information	4
2 Install	2-1. Suffix Code	6
	2-2. Input Type & Range Code	8
	2-3. Rating	9
	2-4. Dimensions & Panel Cutout	10
	2-5. Terminal Arrangement	111
	2-6. Name & Function	4
3 Basic Operation	3-1. Flowchart of Parameter	151
	3-2. Parameter Range & Initial Value	617
	3-3. Monitor Display	181
	3-4. Operation Mode	92
	3-5. Function Mode	3
	3-6. Setup Mode	29
4 Setting Method	4-1. Setting each Channel	33
5 Function	5-1. RUN/STOP	34
	5-2. Batch Setting	35
	5-3. Alarm	39
	5-4. Multi-Memory Zone	40
	5-5. Scan	41
	5-6. RUN/STOP Selection	42
6 Specification	6-1. Input	43
	6-2. Output	44
	6-3. Communication	44
	6-4. Error Code	

1 BEFORE STARTING

Thanks for purchasing Multi-channels temperature Controller.

This manual shows how to install and use.

The contents of this paragraph are as follows.

- Check the contents of the product
- Safety Information
- Damaged product

In case the product has external damage or some contents are missing, please contact the place where you purchased or our sales department.

1 – 1. Check Contents

■ Check packing contents

Please check whether the following packing contents are included or not.

- Instruction Manual
- MC9 Main Body
- Fixing pin : 2 pcs
- Impedance 250Ω in case of Input V DC : 8 pcs

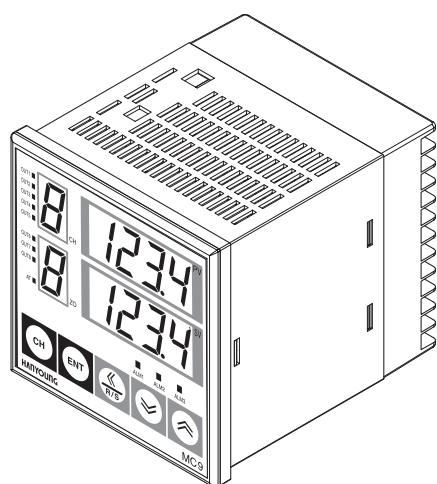

Impedance 250Ω

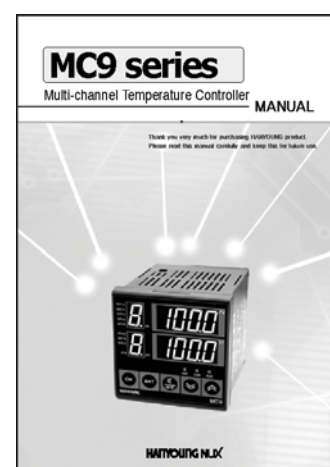
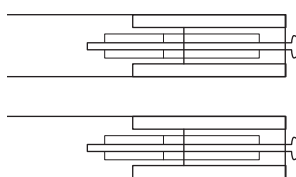

1 – 2. Safety Information

■ Safety notice for this user manual

- Please make this manual to be delivered to the final user and to be placed where can be found and seen easily.
- Please install and operate this product after reading this manual carefully.
- This manual contains detailed information about the product and any matter not mentioned in this manual cannot be guaranteed.
- This manual is written carefully, but please call us if you find any error, parts that can be improved, and omission.
- Contents of this user manual can be edited without prior notice for improvement and modification of the product.

■ Safety notice for the product

- For safety and security of the system that is connected to the product, please read and follow this manual carefully.
- We are not responsible for any damage and safety problem due to the disregard of the manual or lack of care.
- Please install any extra safety circuitry or other safety materials outside the product for safety of the program that is connected to the product.
- Do not disassemble, repair or reconstruct the product. It can cause electric shock, fire, and errors.
- Do not give impact to products. It can cause of damage or malfunction.

■ Notice about responsibilities

- Unless it is included company's conditions for warrantee, we are not responsible for any warranties or guarantees.
- We are not responsible for any damages and indirect loss of the use or third person due to unpredicted natural disasters.

■ Notice about quality guarantee conditions

- The warranty for this product is valid for 1 year from purchase, and we will fix any breakdowns and faults from proper uses as it is mentioned in this manual for free.
- After the warranty period, repair will be charged according to our standard policies.

- Under following conditions, repair will be charged even during warranty period.
- Breakdowns due to user's misuses
- Breakdowns due to natural disasters
- Breakdowns due to moving the product after installation.
- Breakdowns due to modification of the product
- Breakdowns due to power troubles
- Please call our customer service for A/S due to breakdowns.

■ Notice for installation

Please

- In case of electrical wiring, please power all the of products off.
- Please do not touch the product with wet hands. It can cause electric shock.
- Do not expose the product to any gas pipe, lightening rods, or electrical wires. It can cause explosion and ignition.
- Please do not transfer electricity before installation of this product is completed. It can cause breakdowns.
- It can cause electrical shock and fire when improper power source is used.
- Please do not install the product inclined.
- Please avoid installing the product for following places where
- People can touch terminal unintentionally.
- it is exposed to mechanical shock or vibration
 - Danger of corrosion or combustion of gas exist
 - Temperature changes too frequently
 - Temperature is either too high (Over 50°C) or too low (Below 0°C) (If you use our product below 10°C, please run warming up over 30 minutes)
- It is exposed to direct rays
- It is exposed to electromagnetic waves too much
- Humid place (Over 85% humidity places)
- It has many combustible objects
- It has dusts and salinity
- It is exposed to an object that generates heat
- It is exposed to noise.

2 INSTALL

2 – 1. Suffix Code

■ Suffix Code of 4 channels

MODEL	CODE	CONTENTS
MC9-4	<input type="checkbox"/> + <input type="checkbox"/> <input type="checkbox"/> + <input type="checkbox"/> <input type="checkbox"/> + <input type="checkbox"/> + <input type="checkbox"/>	4 Channels Temp. Controller
Control Direction	D	Direct operation
	R	Reverse operation
	W	Heating / Cooling
Input	<input type="checkbox"/> <input type="checkbox"/>	Refer to inputs sheet
Output1~4(Heating Output)	M	Relay
	S	SSR
	T	TRIAC
	4	Current (4 – 20 mA)
	5	Current (0 – 20 mA)
Output 5-8 (Cooling Output) In case of D&R, N is fixed. In case of W, choose among M, S, T, 4 & 5	N	NONE
	M	Relay
	S	SSR
	T	TRIAC
	4	Current (4 – 20 mA)
Option(Alarm, Communication, (Contact Input & HBA) * Loading Alarm Output AL1 basically	5	Current (0 – 20 mA)
	N	None
	1	AL 2, 3
	2	AL2, 3 + RS232 + Contact Input
	3	AL2, 3 + RS422/485 + Contact Input
Power Voltage	4	AL 2, 3 + HBA
	1	24 V a.c / d.c (50/60 Hz) – Not ready
	2	100 – 240 V a.c (50 / 60 Hz)
	3	100 V d.c

■ Suffix Code of 8 channels

MODEL	CODE						CONTENTS
MC9-8	<input type="checkbox"/>	<input type="checkbox"/>	<input type="checkbox"/>	<input type="checkbox"/>	<input type="checkbox"/>	<input type="checkbox"/>	Digital Multi channels Temp. controller
Control Direction	D						Direct operation
	R						Reverse Operation
Input	<input type="checkbox"/>	<input type="checkbox"/>					Refer to inputs sheet
Output 1~4	M						Relay
	S						SSR
	T						TRIAC
	4						Current (4 – 20 mA)
	5						Current (0 – 20 mA)
Output 5~8	N						NONE (Input 5 – 8 : Indicator)
	M						Relay
	S						SSR
	T						TRIAC
	4						Current (4 – 20 mA)
Option(Alarm,Communication, (Contact Input & HBA) * Loading Alarm Output AL1, AL2 & AL3 basically	N						None
	2						RS 232 + Contact Input
	3						RS 422 / 485 + Contact Input
	4						HBA
Power Voltage	1						24 V a.c / d.c (50/60 Hz) – Not ready
	2						100 – 240 V a.c (50 / 60 Hz)
	3						100 V d.c

2 – 2. Input Type & Range Code

Input Type	Input Range (°C)	Code
K	-200 ~ 1370	K0
	-199.9 ~ 999.9	K1
J	-200 ~ 1200	J0
	-199.9 ~ 999.9	J1
R	0 ~ 1700	R0
	0.0 ~ 999.9	R1
S	0 ~ 1700	S0
	0.0 ~ 999.9	S1
B	0 ~ 1800	B0
	0.0 ~ 999.9	B1
E	-200 ~ 1000	E0
	-199.9 ~ 999.9	E1
N	-200 ~ 1300	N0
	-199.9 ~ 999.9	N1
T	-199.9 ~ 400.0	T0
W	0 ~ 2300	W0
PL2	0 ~ 1390	A0
U	-199.9 ~ 600.0	U0
L	-199.9 ~ 900.0	L0
Pt100	-199.9 ~ 600.0	D0
JPt100	-199.9 ~ 500.0	P0
0-5 V	-199.9 ~ 999.9	V0
1-5 V	-199.9 ~ 999.9	V1
0-10 V	-199.9 ~ 999.9	V2

2 – 3. Rating

Items	Description
Power Voltage	100 – 240 V a.c, (50 – 60 Hz) ($\pm 10\%$)
Consumption	Maximum 4W
Input Type	Thermocouple : K, J, R, S, B, E, N, T, W5RE/W26RE, PL2, U, L RTD : Pt 100 Ω (DIN), Pt100 Ω (KS/JIS) Direct Voltage : 0 – 5 V, 0 – 10 V, 1 – 5 V
Display Extent	Thermocouple : ($\pm 0.3\%$ of span + 1 Digit) or $\pm 2\text{ }^{\circ}\text{C}$ [2°F] Irrespective of any side, Bigger side RTD : ($\pm 0.3\%$ of span + 1 Digit) or $\pm 0.8\text{ }^{\circ}\text{C}$ [$1.6\text{ }^{\circ}\text{F}$] Irrespective of any side, Bigger side Direct Voltage : ($\pm 0.3\%$ of span + 1 Digit)
Effect of Signal Resistance	About 0.2 $\mu\text{V} / \Omega$
Effect of Input Resistance	About 0.01 % / Ω
Input Impedance	About 1 M Ω
Allowable Input Voltage	TC, RTD : 5 ~ - 2 V V d.c : 12.5 ~ - 5 V
Extent of RJC	$\pm 1.5\text{ }^{\circ}\text{C}$ (0 ~ 50 $^{\circ}\text{C}$), $\pm 1\text{ }^{\circ}\text{C}$ (10 ~ 35 $^{\circ}\text{C}$)
Burn Out Scale	Direct Control : Down-scale Reverse Control : Up-scale
Control Type	ON/OFF, P, PI, PD, PID Control Direct Control & Reverse Control
Contact Input	On : less than 2 k Ω , Off : over 15 k Ω
Sampling Cycle	1s
Control Output	<ul style="list-style-type: none"> Relay Output : 250 V a.c, 3A Resistive Load, Proportional Time : 0 ~ 100 ms Time Resolution : 0.1 % or 10 ms Voltage Pulse: Off :less than 0.1V d.c, On: over 12 V d.c Load :over 600 Ω Time Proportional 0~100s Current Output: 0 -20 mA d.c, 4-20 mA d.c Resistive Load : less than 600 Ω Extent : $\pm 1\%$ of span Triac : 200 V a.c, 0.5 A(Ambient Temperature is less than 40 C) Zero Crossing function.

Alarm Output	Alarm 1, 2, 3 : 250 V a.c, 1 A (Resistive Load) HBA : Current Transformer(CT) 0 ~100 A (J&D ELETRONIC. Co., Ltd) Extent : $\pm 5\%$ of span or ± 2 A Bigger side
Insulation Resistance	Measure & Power terminal : 20 M Ω in 500 V d.c
Dielectric Strength	Power & Measure terminal : 1 min in 2300 V a.c
Memory Backup	Memory by EEPROM Life span of EEPROM: 100,000 writing possible, Storage data for almost 10 years
Setting Method	Digital setting by +/- key LED display
Display Type	7 Segments High LED display
Others	Zone function, HBA(Heater Break Alarm), Rate function, Input compensation, Channel enable, Input filter, Memory, Scan, Auto-tuning, Alarm Output, Heating/Cooling
Operation Condition	Ambient Temperature : 0 ~ 50 $^{\circ}$ C Ambient Humidity : 35 ~ 85 % R.H.(No condensation)

2 - 4. Dimentions & Panel Cutout

(Unit : mm)

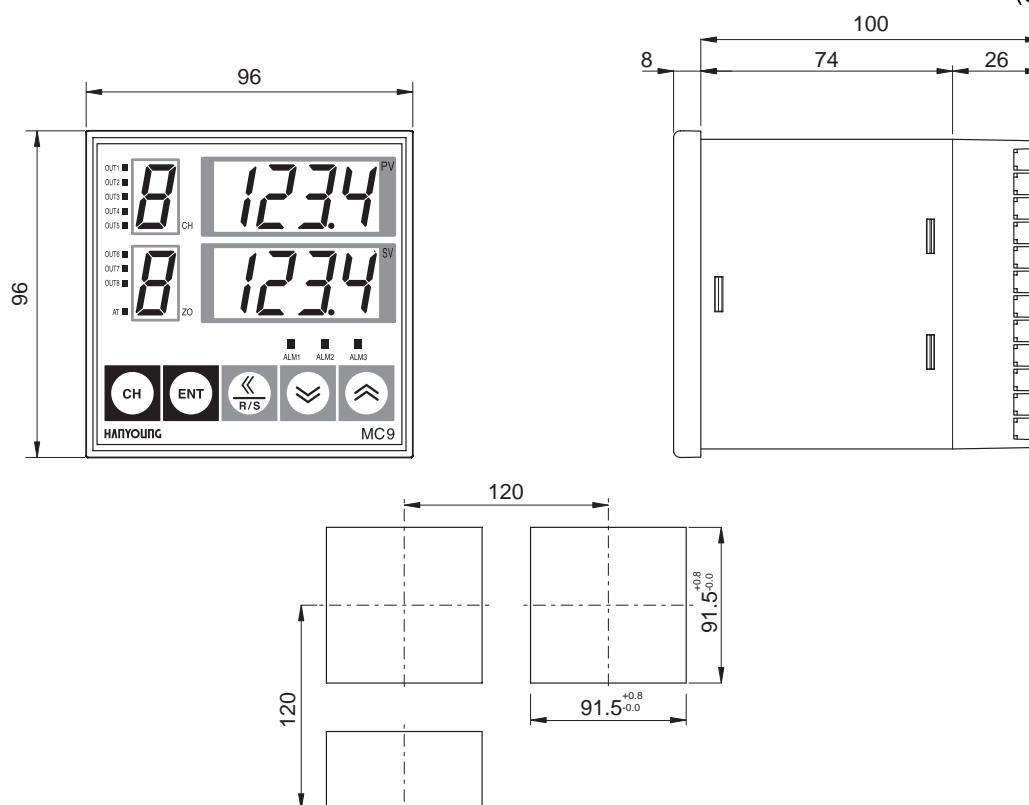

www.famcocorp.com

E-mail: info@famcocorp.com

@famco_group

Tel: ۰۲۱-۴۸۰۰۰۰۴۹

Fax : ۰۲۱ - ۴۴۹۹۴۶۴۲

تهران، کیلومتر ۲۱ بزرگراه لشگری (جاده مخصوص کرج)

روبروی پالایشگاه نفت پارس، پلاک ۱۲

2 – 5. Terminal Arrangement

■ Connections

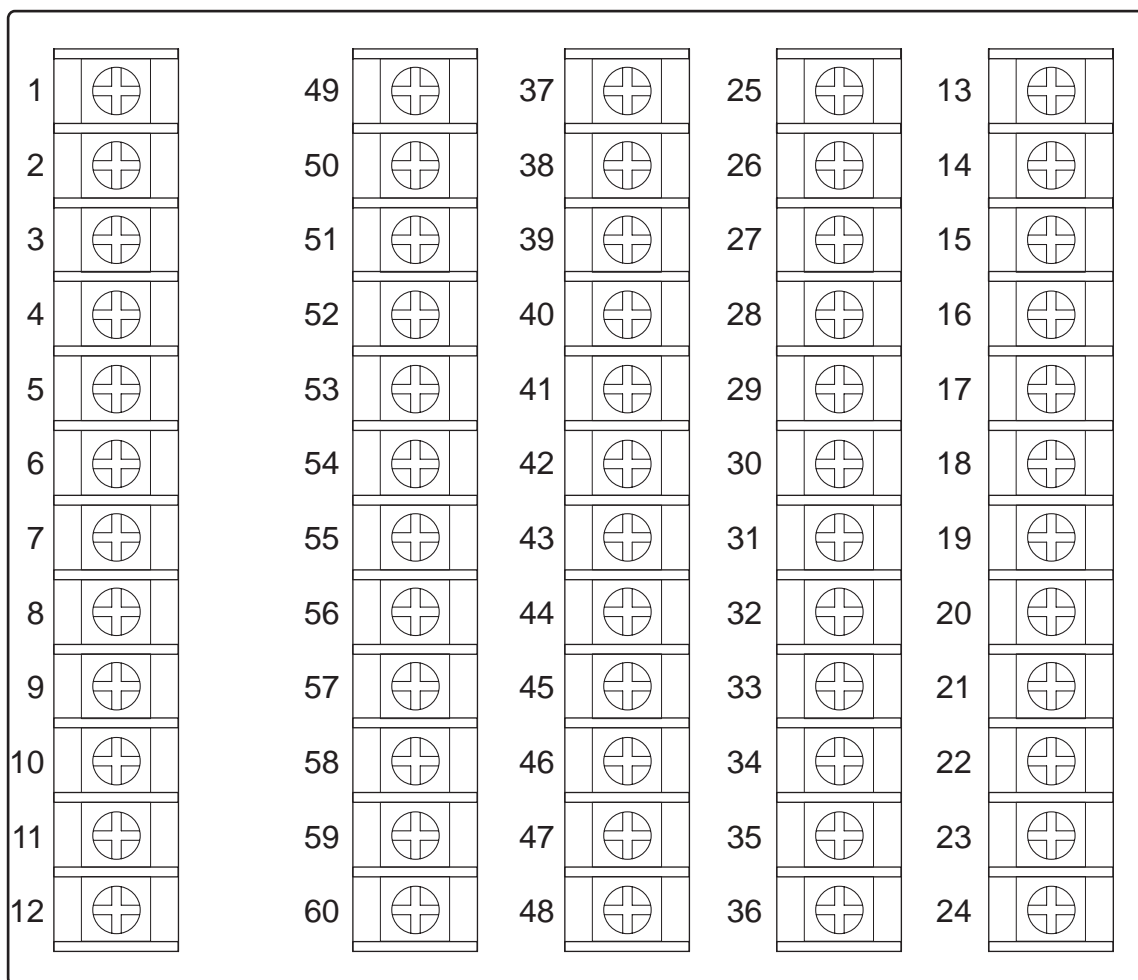

■ Output 1 (out 1 ~ 4)

NO	Description
1	 100-220 V a.c Voltage Input
2	
3	 NO Alarm 1 Output
4	
5	 NO Output 1 (1) Relay (2) SSR / Current (3) Triac
6	
7	 NO Output 2 (1) Relay (2) SSR / Current (3) Triac
8	
9	 NO Output 3 (1) Relay (2) SSR / Current (3) Triac
10	
11	 NO Output 4 (1) Relay (2) SSR / Current (3) Triac
12	

■ Output 2 (out 5 ~ 8)

NO	Description
49	 NO Alarm 2 Output
50	
51	 NO Alarm 3 Output
52	
53	 NO Output 5 (1) Relay (2) SSR / Current (3) Triac
54	
55	 NO Output 6 (1) Relay (2) SSR / Current (3) Triac
56	
57	 NO Output 7 (1) Relay (2) SSR / Current (3) Triac
58	
59	 NO Output 8 (1) Relay (2) SSR / Current (3) Triac
60	

■ Option 1 (1)-DI/COM

NO	Description
37	
38	
39	
40	
41	
42	
43	
44	
45	
46	
47	
48	

■ Option 2 (2)-HBA

NO	Description
37	
38	
39	
40	
41	
42	
43	
44	
45	
46	
47	
48	

■ Input (1) 1 ~ 4 Channels

NO	Description
13	
14	
15	
16	
17	
18	
19	
20	
21	
22	
23	
24	

■ Input (2) 5 ~ 8 Channels

NO	Description
25	
26	
27	
28	
29	
30	
31	
32	
33	
34	
35	
36	

2 -6. Name & Function

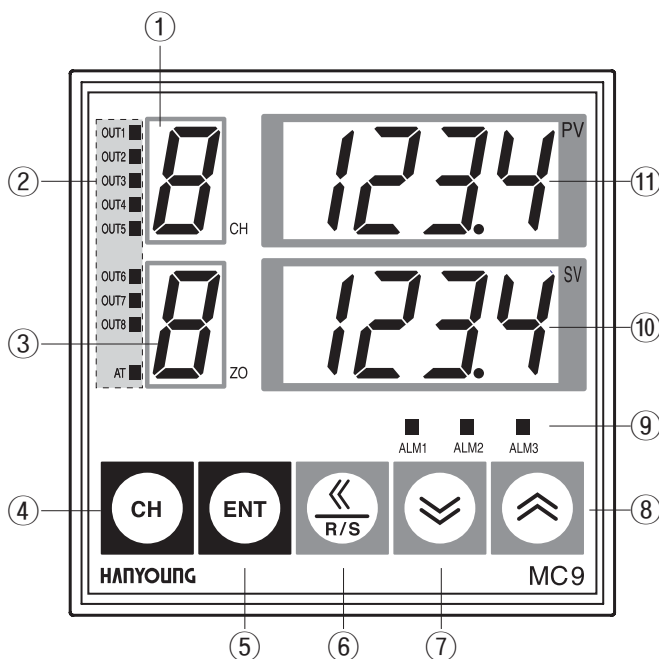

- ① : Window for displaying Channel ("A" Batch Setting)
- ② : Indicate Lamp(Output 1~8,AT)
- ③ : Window for displaying Memory Zone (Display Memory Zone)
- ④ : Key for changing Chanel
- ⑤ : Setting Key
- ⑥ : Shift & Reset Key
- ⑦ : Key for decreasing Set-values(SV)
- ⑧ : Key for increasing Set-Values(SV)
- ⑨ : Alarm Output Lamp(Alarm 1~3)
- ⑩ : Window for displaying Set-Values (SV window)
- ⑪ : Window for displaying Process-Values (PV window)

NO.	Paramete	Description
①	Channel Display	Monitor screen: Displays the channel of PV/SV currently. Screen except Monitor: Displays Parameter Channel for setting currently.
②	Output/AT	Lights Lamp when Output 1~8 is on. Flickers Lamp when the displayed channel is in AT currently.
③	Memory Range	Monitor screen: Displays the number of controlling Zone currently. Screen except Monitor: Displays the number of Parameter Zone for setting currently.
④	CH Key	Monitor screen: Press this key for 1 sec to change Auto-scan during scanning each. Channel to scan is changed by pressing CH Key during scanning each. Screen except Monitor: Changes the Channel number of Parameter for setting currently.
⑤	ENT key	Saves Parameter changed or turns into the next Parameter.
⑥	⏪ key	Monitor screen: Starting or finishing Control by pressing for 1 sec. Screen except Monitor: Operating by Shift-Key.
⑦	⏴ key	Decreases Parameter Values.
⑧	⏵ key	Increases Parameter Values.
⑨	ALM1~3	Lights Lamp when Alarm Output is on.
⑩	SV Window	Monitor screen: Displays Set-Value(SV). Screen except Monitor: Displays Parameter Value.
⑪	PV Window	Monitor screen: Displays Process-Value(PV). Screen except Monitor: Displays Parameter name as an abbreviation.

3 Basic Operation

3 - 1. Flowchart of Parameter

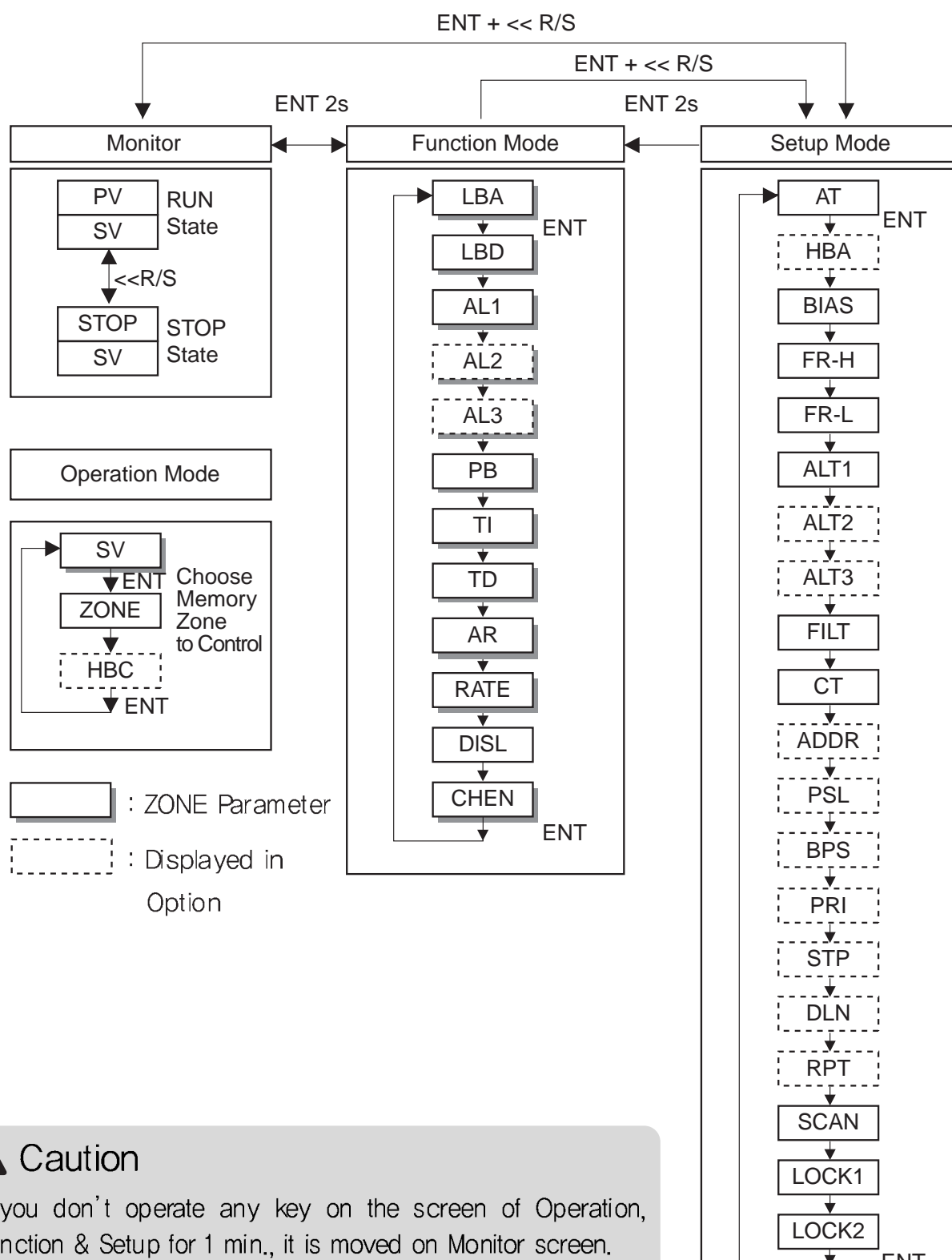

⚠ Caution

If you don't operate any key on the screen of Operation, Function & Setup for 1 min., it is moved on Monitor screen.

www.famcocorp.com

E-mail: info@famcocorp.com

@famco_group

Tel: ۰۲۱-۴۸۰۰۰۰۴۹

Fax: ۰۲۱-۴۴۹۹۴۶۴۲

تهران، کیلومتر ۲۱ بزرگراه لشگری (جاده مخصوص کرج)

روبروی پالایشگاه نفت پارس، پلاک ۱۲

3 – 2. Parameter Range & Initial Value

Signal	Name	Range	Initial Value	Unit	Area	CH
SV	Set Value	EU(0 ~ 100 %)	EU(0 %)	EU	○	○
ZONE	Memory Zone	1 ~ 8	1	ABS	○	○
HBC	Heater Break Current	0.0 ~ 100.0	0.0	Ampere	×	○
LBA	Loop Break Alarm	OFF, 0.1 ~ 200.0	8.0	Min	○	○
LBD	Loop Break Alarm Deadband	EUS(0 ~ 100 %)	EUS (0 %)	EUS	○	○
AL1	Alarm 1	Refer to 5 – 3 Alarm			○	○
AL2	Alarm 2				○	○
AL3	Alarm 3				○	○
PB	Proportional Band	EU(0 ~ 100 %)	30.0 °C /3.0 %	EU	○	○
TI	Time of Integral	0 ~ 3600	240	sec.	○	○
TD	Time of Derivative	0 ~ 3600	60	sec.	○	○
AR	Anti-Reset Windup	0 ~ 100	0 (AUTO)	%	○	○
RATE	SV rate	EUS(0 ~ 100 %)	OFF	EUS	○	○
DISL	DI Select	0, 1	0		×	×
CHEN	Channel Enable	OFF, MONI, CONT	CONT	ABS	○	○
AT	Auto-Tuning	OFF, ON	OFF	ABS	○	○
HBA	Heater Break Alarm	OFF, 0.0 ~ 100.0	OFF	Ampere	×	○
BIAS	Bias	EUS(0 ~ 100 %)	0.0	EUS	×	○
FR-H	Range High Limit	FR-L~High Limit	High Limit	EU	×	×
FR-L	Range Low Limit	Low Limit~FR-H	High Limit	EU	×	×
ALT1	Alarm 1 type	0 ~ 16	0		×	×
ALT2	Alarm 2 type	0 ~ 16	0		×	×
ALT3	Alarm 3 type	0 ~ 16	0		×	×
FILT	Filter	OFF, 1 ~ 100	OFF	sec.	×	○
CT	Cycle Time	1 ~ 100	20/2	sec.	×	○
ADDR	Address	1 ~ 99	1	ABS	×	×
PSL	Protocol select	0, 1	0		×	×
BPS	Bits Per Second	0 ~ 3	3	ABS	×	×
PRI	Parity	0 ~ 2	0	ABS	×	×
STP	Stop Bit	1, 2	1	ABS	×	×
DLN	Data Length	7, 8	8	ABS	×	×
RPT	Response Time	0 ~ 10	0	ABS	×	×
SCAN	Scan Time	1 ~ 10	2	sec.	×	×
LOC1	Lock 1	Refer To LOC 1		ABS	×	×

www.famcocorp.com

E-mail: info@famcocorp.com

@famco_group

Tel: ۰۲۱-۴۸۰۰۰۰۴۹

Fax: ۰۲۱-۴۴۹۹۶۶۴۲

تهران، کیلومتر ۲۱ بزرگراه لشگری (جاده مخصوص کرج)

روبروی پالایشگاه نفت پارس، پلاک ۱۲

3 – 3. Monitor Display

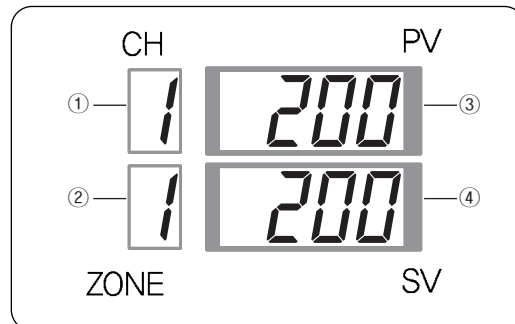

This screen is to check Process-Value(PV) & Set-Value(SV) come under Channel number displayed on CH window. Channel number is changed by pressing CH key (Each Scan), and automatically it is changed by doing CH key for 1 sec. over(Auto Scan).

Scanned time is decided in "Scan" Parameter in that time(Refer to "SCAN" in Setup Mode).

* If SV Rate is operated, Rated SV is displayed.

* If PV is on stop running, it displays STOP(Refer to 5-1. RUN/STOP). In case of an error, it displays ERROR(Refer to 6-4. Error Code).

- ① Monitor screen: Displays the channel of PV/SV currently.
Screen except Monitor: Displays the number of Parameter Channel (CH) for setting currently.
- ② Monitor screen: Displays the number of controlling Zone currently.
Screen except Monitor: Displays the number of Parameter Zone for setting currently.
- ③ Monitor screen: Displays current Process-Value(PV).
Screen except Monitor: Displays Parameter name as an abbreviation.
- ④ Monitor screen: Displays Set-Value(SV).
Screen except Monitor: Displays Parameter Value

3- 4. Operation Mode

Set SV & Zone to control. Also you can check HBA value in case of HBA option.

<p>CH PV</p> <p><input type="checkbox"/> <input type="checkbox"/></p> <p><input type="checkbox"/> <input type="checkbox"/></p> <p>1 0</p> <p>ZONE SV</p>	<p>Initial Value : 0 °C, 0.0 °C</p> <p>Setting range : Within input range.</p> <p>Contents : Set SV</p> <p> Allowable to set 8 SV in maximum from 1CH to 8CH.</p> <p> Allowable to set SV as the same value simultaneously from 1CH to 8CH.</p>
---	--

<p>CH PV</p> <p><input type="checkbox"/> <input type="checkbox"/></p> <p><input type="checkbox"/> <input type="checkbox"/></p> <p>1 1</p> <p>ZONE SV</p>	<p>Initial Value : 1</p> <p>Setting range : 1 ~ 8</p> <p>Contents : Set Memory range(ZONE) to control.</p> <p> Save Setting value per each channel to Memory zone in maximum 8(Available to create Setting value per each channel 8 * 8 Zone =64)</p>
---	---

3 – 5. Function Mode

If you press ENT key in monitor screen for 2 sec. , it enters into Function mode. Generally users create setting value easily on occasion in selecting function mode.

There are functions as follows ; LBA, Alarm 1, Alarm 2, Alarm 3

P, I, D needed to control,

Rate (In case SV is changed by AR value & Variation of SV)

CHEN(Not displayed a channel not to use)

You can select by ENT key. It is available to register and change setting value by using

⏪, ⏩, ⏴ keys.

■ Description of each parameter

● LBA : Control Loop Break Alarm

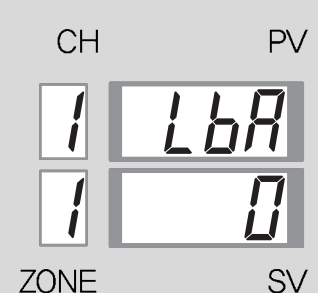
	Initial Value	: 8 min
	Setting range	: 0.1~200.0 min
	Contents	: LBA watches variation of PV and set time to detect any abnormal control loop. Displayed in case only LBA is set in alarm 1. If AT operates, double TI is set automatically. No operate in case LBA is Off.
	Operation	: In case output is 0% and control direction is direct If PV value is not rising over 2C(2F,2%) within setting time in LBA, it happens. In case output is 0% and control direction is reverse If PV value is not falling over 2C(2F,2%) within setting time in LBA, it happens. In case output is 100% and control direction is direct If PV value is not falling over 2C(2F,2%) within setting time in LBA, it happens. In case output is 100% and control direction is reverse If PV value is not rising over 2C(2F,2%) within setting time in LBA, it happens.

www.famcocorp.com

E-mail: info@famcocorp.com

@famco_group

Tel: ۰۲۱-۴۸۰۰۰۰۴۹

Fax: ۰۲۱-۴۴۹۹۴۶۴۲

تهران، کیلومتر ۲۱ بزرگراه لشگری (جاده مخصوص کرج)

روبروی پالایشگاه نفت پارس، پلاک ۱۲

● LBD : Control Loop Break Alarm Deadband

CH	PV	Initial Value : Voltage input : 0 °C, 0.0 °C Setting range : 0 ~ 100 sec Contents : Contents: Set all extents except the range of errors occurred. Displayed in case only LBA is set in alarm 1. Not operated if LBA setting value is set as "0".
1	Lbd	
1	1	
ZONE	SV	

● AL 1 : Alarm 1

CH	PV	Initial Value : Maximum value of range (Refer to Input type & Range code) Setting range : Range(Refer to Input type & Range code) Contents : Set the setting value of Alarm 1. Displayed in case only LBA is set in alarm 1. Not displayed if alarm type is FAIL or LBA(HBA).
1	AL 1	
1	0	
ZONE	SV	

● AL 2 : Alarm 2

CH	PV	Initial Value : Maximum value of range (Refer to Input type & Range code) Setting range : Range(Refer to Input type & Range code) Contents : Set the setting value of Alarm 2. Displayed in case only LBA is set in alarm 2. Not displayed if alarm type is FAIL or LBA(HBA).
1	AL 2	
1	0	
ZONE	SV	

● AL 3 : Alarm 3

CH	PV	Initial Value : Maximum value of range (Refer to Input type & Range code) Setting range : Range(Refer to Input type & Range code) Contents : Set the setting value of Alarm 3. Displayed in case only LBA is set in alarm 3. Not displayed if alarm type is FAIL or LBA(HBA).
1	AL 3	
1	0	
ZONE	SV	

www.famcocorp.com

E-mail: info@famcocorp.com

@famco_group

Tel: ۰۲۱-۴۸۰۰۰۰۴۹

Fax: ۰۲۱-۴۴۹۹۴۶۴۲

تهران، کیلومتر ۲۱ بزرگراه لشگری (جاده مخصوص کرج)

روبروی پالایشگاه نفت پارس، پلاک ۱۲

● PB : Proportional Band

CH	PV	Initial Value : 30 °C, 30.0 °C, Voltage input : 3.0 % Setting range : 0(0.0) ~ Maximum value of range Contents : Set PB to control P, PI, PD & PID. If you operates AT, it is set automatically.
1	Pb	
1	0	
ZONE	SV	

ON/OFF : If it set as PB=0, operate ON/OFF control.

● TI : Integral Time

CH	PV	Initial Value : 60 sec. Setting range : 1 ~ 3600 sec. Contents : Contents: Set Integral operation time.. If you operates AT, it is set automatically.
1	ti	
1	240	
ZONE	SV	

● TD : Derivative Time

CH	PV	Initial Value : 60 sec. Setting range : 1 ~ 3600 sec. Contents : Set Derivative operation time . If you operates AT, it is set automatically.
1	td	
1	60	
ZONE	SV	

● Anti Reset Windup

CH	PV	Initial Value : 0 (Auto) Setting range : 0 (Auto) ~ 100 % Contents : Set the range of valid operation in Integral operation to prevent from overshoot by the effect of over-integral. If set Ar=0 it operates automatically.
1	Ar	
1	100	
ZONE	SV	

● Rate : SV Rate

CH	PV	Initial Value : OFF Setting range : 0 (0.0) ~ maximum range / min Contents : Set SV variation per min. If it is Off, it doesn't operates. If you change SV in RUN, Rate operates. If you operate AT during Rate is operating, Rate is stopped at once and AT operates as new SV.
1	rATE	
1	off	
ZONE	SV	

● DISL : DI Select

CH	PV	Initial Value : 0 Setting range : 0, 1 Contents : Select whether you use DI function or now 0 : Not used DI 1 : Used DI
□	di SL	
□	0	
ZONE	SV	



● CHEN : Channel Enable

CH	PV	Initial Value : CONT Setting range : OFF, CONT, MONI Contents : Select whether you use each channel about each Memory zone or not. OFF : Appoint a channel not used. Not displayed a channel display in setting Off. CONT : become normal control condition. MONI : Displayed only PV value and Not
1	CHEN	
1	off	
ZONE	SV	

3 – 6. Setup Mode

If you press ENT key +  key in the monitor screen or Function mode, you can enter into Setup mode.

Generally Setup mode is used when user builds system. There are AT, HBA, BIAS, FILT, CT, Communication mode parameter, LOCK1/LOCK2 & etc.

You can register & change Setting value by choosing , ,  keys.

■ Description of each parameter

● AT : Auto – Tuning

<div style="display: flex; justify-content: space-around; margin-bottom: 5px;"> CH PV </div> <div style="display: flex; justify-content: space-around; margin-bottom: 5px;"> <div style="border: 1px solid black; padding: 2px; width: 30px; text-align: center;">1</div> <div style="border: 1px solid black; padding: 2px; width: 60px; text-align: center;">AT</div> </div> <div style="display: flex; justify-content: space-around; margin-bottom: 5px;"> <div style="border: 1px solid black; padding: 2px; width: 30px; text-align: center;"> </div> <div style="border: 1px solid black; padding: 2px; width: 60px; text-align: center;">OFF</div> </div> <div style="display: flex; justify-content: space-around;"> ZONE SV </div>	<p>Initial Value : OFF</p> <p>Setting range : OFF, ON</p> <p>Contents : Set whether At operates or not.</p> <p>AT operation : If you press ENT key after AT parameter is On, AT operates & AT lamp flickers.</p> <p>AT cancel : AT is cancelled automatically as follows: When AT parameter is Off When SV is changed Burn-out When ADC error happens Running is stopped When you operate AT of 8 channels simultaneously, channel parameter becomes "1->2->...->A" by pressing CH key. When "A" is shown, change Off in the window SV into On. AT of all channels operates by pressing ENT key simultaneously. When you operates AT in a channel only, AT is On after you choose channel by pressing CH key. AT operates in the channel wanted in that time.</p>
--	--

● HBA : Heater Break Alarm 1

<p>CH PV</p> <p>1 HBA</p> <p>OFF</p> <p>ZONE SV</p>	<p>Initial Value : OFF</p> <p>Setting range : 0.0 ~ 100.0 A</p> <p>Contents : If you choose HBA option & Alarm type, you can know Current value in detected in HBC of operation mode.</p> <p>Set HBA value as 85% of Current load. HBA can't be used in case of Current output. Set HBA SV a little bit lower when variation of power supply is big.</p> <p>Current detection extent : $\pm 5\%$ of span</p> <p>Current detection resolution: 0.5 A</p> <p>Detection method: Detect Heater Current after output is On(200ms). If On time(CT* output %) is less than 200ms, it doesn't proceed detection operation. Detection operation : When HBA value is bigger than HBC value after detection is finished, Alarm operates.</p>
---	--

● BIAS : PV Bias

<p>CH PV</p> <p>1 BIAS</p> <p>0</p> <p>ZONE SV</p>	<p>Initial value : 0 °C, 0.0 °C, Voltage input 0.0 %</p> <p>Setting range : EUS (0 ~ 100 %)</p> <p>Contents : If measured value is different from standard value as sensor compensation function, it is the function to meet by compensating as the amount of deviation.</p>
--	--

● FR-H : Range High Limit

<p>CH PV</p> <p>FR-H</p> <p>1300</p> <p>ZONE SV</p>	<p>Initial value : Upper of input range</p> <p>Setting range : FR-L~Upper of input range</p> <p>Contents : Set upper value in the input range for user. If input value is higher than this one, OVR or bout happens.</p>
---	--

www.famcocorp.com

E-mail: info@famcocorp.com

@famco_group

Tel: ۰۲۱-۴۸۰۰۰۰۴۹

Fax : ۰۲۱ - ۴۴۹۹۴۶۴۲

تهران، کیلومتر ۲۱ بزرگراه لشگری (جاده مخصوص کرج)

روبروی پالایشگاه نفت پارس، پلاک ۱۲

● FR-L : Range Low Limit

CH	PV	Initial value : Lower of input range
[]	Fr-L	
[]	-200	Setting method : Set the lower of input ~ FR-H
ZONE	SV	Contents : Set Lower value of input range. If input value is lower than this one, -OVR or bout happens.

● ALT1 : Alarm 1 type

CH	PV	Initial value : 0
[]	ALT1	
[]	0	Setting range : 0 ~ 16
ZONE	SV	Contents : Set type of Alarm 1 Refer to 5-3 Alarm

● ALT2 : Alarm 2 type

CH	PV	Initial value : 0
[]	ALT2	
[]	0	Setting range : 0 ~ 16
ZONE	SV	Contents : Set type of Alarm 2. Refer to 5-3. Alarm.

● ALT3 : Alarm 3 type

CH	PV	Initial value : 0
[]	ALT3	
[]	0	Setting range : 0 ~ 16
ZONE	SV	Contents : Set type of Alarm 3. Refer to 5-3. Alarm.

www.famcocorp.com

E-mail: info@famcocorp.com

@famco_group

Tel: ۰۲۱-۴۸۰۰۰۰۴۹

Fax: ۰۲۱-۴۴۹۹۴۶۴۲

تهران، کیلومتر ۲۱ بزرگراه لشگری (جاده مخصوص کرج)

روبروی پالایشگاه نفت پارس، پلاک ۱۲

● **FILT : Filter**

CH	PV	Initial value : OFF
[]	FILT	
1	OFF	Setting range : 0 ~ 120 s
ZONE	SV	Contents : Set the first time of delayed filter to remove any noise in the measured input value.

● **CT : Cycle Time**

CH	PV	Initial value : Relay 20 s, SSR & TRIAC : 2 s
1	CT	
[]	20	Setting range : 1 ~ 100 s
ZONE	SV	Contents : Set the cycle of control output. Set output cycle in case of Relay, Pulse & Triac output. It is not applied in case of Current output.

● **ADDR : Address**

CH	PV	Initial value : 1
[]	Add	
[]	0	Setting range : 1 ~ 99
ZONE	SV	Contents : If communication option is chosen, Parameter is displayed. It is appointed address of instrument in case of RS232/485/422 communication. Refer to Communication manual in detail.

● **BPS : Bits per Second**

CH	PV	Initial value : 0
[]	PSL	
[]	0	Setting range : 0, 1
ZONE	SV	Contents : Set type of Communication Protocol 0 : pc link sum None 1 : pc link sum Existed

● PRI : Parity

CH	PV	Initial value	: 0
[]	[Pri]	Setting range	: 0 ~ 2
[]	[OFF]	Contents	: Set Communication Parity If communication option is chosen, Parameter is displayed
ZONE	SV		0 : NONE 1 : EVEN 2 : ODD

● STP : Stop Bit

CH	PV	Initial value	: 1
[]	[STP]	Setting range	: 1 ~ 2
[]	[20]	Contents	: Set Communication Stop Bit. If communication option is chosen, Parameter is displayed
ZONE	SV		1 : 1 BIT 2 : 2 BIT

● DLN : Data Length

CH	PV	Initial value	: 7
[]	[dLn]	Setting range	: 7 ~ 8
[]	[OFF]	Contents	: Set Communication Data Length. . If communication option is chosen, Parameter is displayed
ZONE	SV		7 : 7 BIT 8 : 8 BIT

● RPT : Response Time

CH	PV	Initial value	: 0
[]	[RPT]	Setting range	: 0 ~ 10
[]	[20]	Contents	: Set Communication Response Time. If communication option is chosen, Parameter is displayed. Response time = Processing time + RPT * 20ms

www.famcocorp.com

E-mail: info@famcocorp.com

@famco_group

Tel: ۰۲۱-۴۸۰۰۰۰۴۹

Fax: ۰۲۱-۴۴۹۹۴۶۴۲

تهران، کیلومتر ۲۱ بزرگراه لشگری (جاده مخصوص کرج)

روبروی پالایشگاه نفت پارس، پلاک ۱۲

● SCAN : Scan Interval Time

<p>CH PV</p> <p><input type="checkbox"/> SCAN</p> <p><input type="checkbox"/> OFF</p> <p>ZONE SV</p>	<p>Initial value : 2 s</p> <p>Setting range : 1 ~ 100 s</p> <p>Contents : Set time until current displayed channel is changed into next channel.</p>
--	--

● LOC1 : Lock 1

<p>CH PV</p> <p><input type="checkbox"/> LOC1</p> <p><input type="checkbox"/> 0000</p> <p>ZONE SV</p>	<p>Initial value : 0000</p> <p>Contents : It is an equipment to limit a change of parameter setting by controlling key.</p> <p>DIGIT 1 : Prohibited the setting of all parameters except SV, Alarm1, Alarm2 & Alarm3.</p> <p>0 : Cancel 1 : Lock</p> <p>DIGIT 2 : Prohibited the setting of Alarm1, Alarm2 & Alarm3.</p> <p>0 : Cancel 1 : Lock</p> <p>DIGIT 3 : Prohibited the setting of SV.</p> <p>0 : Cancel 1 : Lock</p> <p>DIGIT 4 : Not used(Fixed "0")</p>
---	--

● LOC2 : Lock 2

<p>CH PV</p> <p><input type="checkbox"/> LOC2</p> <p><input type="checkbox"/> 0000</p> <p>ZONE SV</p>	<p>Initial value : 0000</p> <p>Contents : It is an equipment to limit prohibition of RUN/STOP & Zone change.</p> <p>DIGIT 1 : Prohibited a change of RUN/STOP</p> <p>DIGIT 2 : Prohibited a change of Zone</p> <p>DIGIT 3 : Not used (Fixed "0")</p> <p>DIGIT 4 : Not used(Fixed "0")</p>
---	---

4 Setting Method

4 – 1. Setting each Channel

There are some examples to change SV. Others are applied as same method.



■ SV value setting method

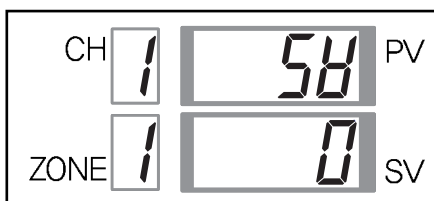

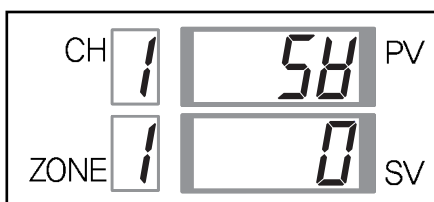

If you want SV value to change CH"1" in Zone "1" from 0C to 300C, please setup as following a procedure .



Pressing ENT button once in PV/SV display mode, SV setting mode is displayed like a figure of the left side.



If you press  button once, "0" of the first SV is flickered. If you press  button again, "00" is flickered and then do once more 0 of "000" is flickered.

And then make 3 By pressing  key. Pressing ENT key again, 300 is registered in setting above. Doing ENT key one more, it is moved on the range of Zone Memory. Ex) 0←0←0←0←0 Whenever you push  key, digit of SV is moved like a figure with flickering operation. Set by using ,  key in sequence of numbers wanted.

■ When you increase SV value(Changing 399 to 400)



● Press  key to flicker Number of 9 unit like Figure [A] once.

Press  key to change into "0" once.

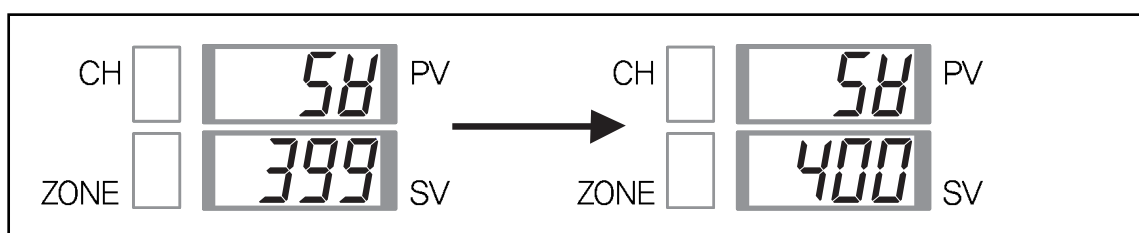
Changed into 400 in the window of SV display like a figure below.



■ When you decrease SV value(Changing 400 to 390)

- Press  key to flicker Number of 10 unit like Figure [A] twice.
- Press  key to change "0" of 10 unit into "9" once.
- Changed into 390 in the window of SV display like a figure below.

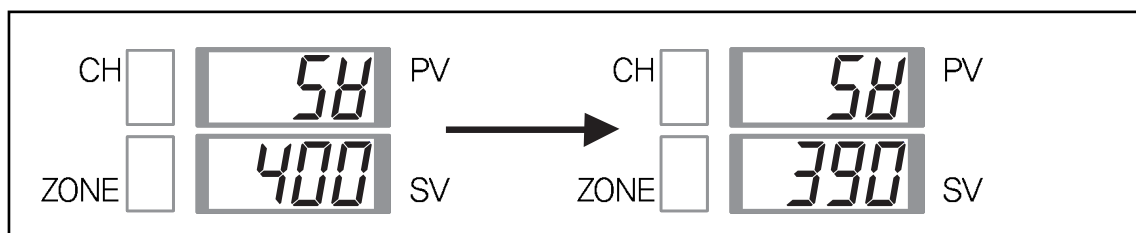



Figure [A]

Figure [B]

■ When you set a value in (-)(Changing 100 to -100)

- Press  key once to flicker Number 9 of unit like Figure [A] three times
- Press  key to change into "0" twice.
- Changed into -100 in the window of SV display like a figure below.

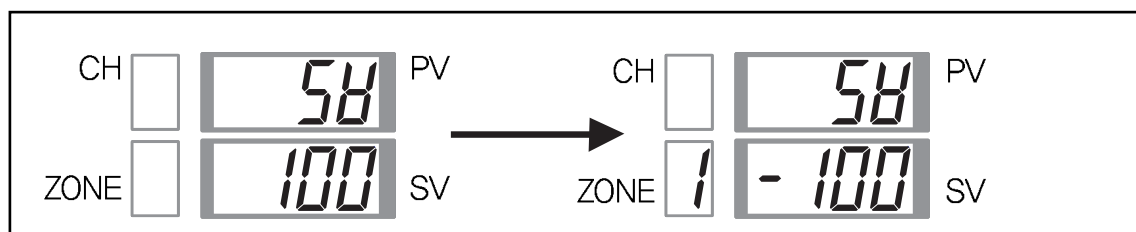
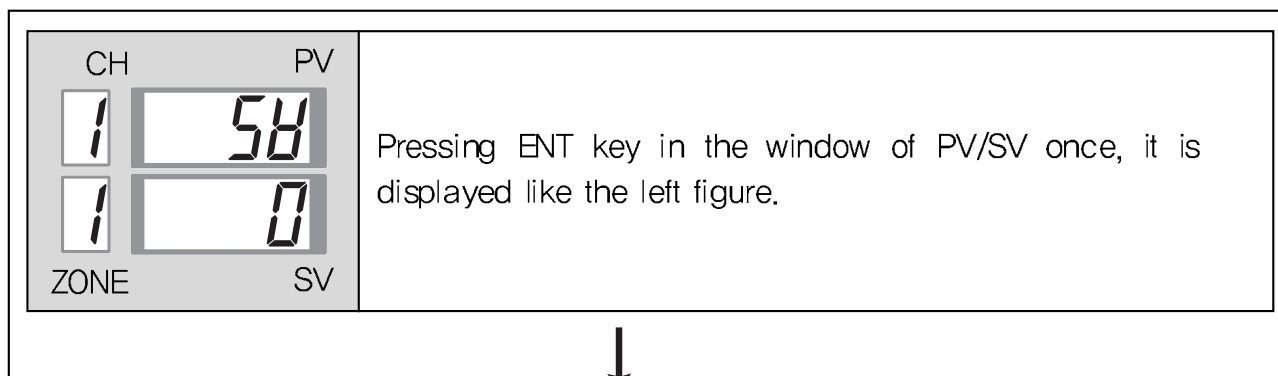

Figure [A]

Figure [B]

■ When you change SV of another Zone without changing current control Zone.

Current control Zone is Zone 1, and changeable Zone is Zone 2. in case of changing SV from 200 to 100 in the channel 2 of Zone 2.





	<p>Whenever you press key to change Zone from Num. 1 to Num.2, digit of SV is displayed in sequence as below. If cursor is come to Num. "1" of Zone, Num "1" is flickered. Pressing ^ key once in that time, "1" is changed into "2". Doing ENT key, a flickering operation of Num. "2" is stopped.</p> <p style="text-align: center;">1 ← 0 ← 0 ← 0 ← 0 ←</p>
--	--



	<p>Pressing CH key to change Num. "1" into "2" in channel number, Num. "1" is changed into Num. "2"</p>
--	---



	<p>Pressing key to change 200 into 100 in SV of Num. "2" three times. It is flickered in 100 by doing V key once. Pressing key once, 200 is changed into 100 and it is flickered in that time. And then Flickering operation is stopped & registered by doing ENT key.</p>
--	--



	<p>Pressing key in the left figure to change Zone number, Zone value is changed.</p>
--	---



	<p>Pressing ENT key in the window of PV/SV display once, it is shown like the left figure.</p>
--	--

■ When you set all SV at the same time["A"]

Set SV in channel 1~8 from 0C to 200C at the same time.

	<p>Pressing ENT key in the window of PV/SV display, it is displayed like the left window. Press CH key. Character "A" is displayed next to number in the window CH display and "----" is displayed in the window of SV display.</p>
--	---

	<p>Character "A" means collective setting. Whenever you press CH key, channel number is changed as follows: 1-2-3-4-5-6-7-8-A</p>
--	---

	<p>Cursor is move to the position of 100 unit by pressing key and 200 is set by pressing key twice. If you press ENT key, SV values of all channels are registered as 200 simultaneously. Parameter is changed into the next parameter.</p>
--	---

Caution

If this procedure is finished, SV of channel not used become collective setting.



5 Function

5 – 1. Run/Stop

● Without DI OPTION

- In PV/SV screen, you can change RUN ↔ STOP by pressing  key.
- In case of STOP, “*STOP*” will be displayed on PV window.

● With DI OPTION

- RUN/STOP DI(Terminal No.37–38) will be connected. By pressing  key, it starts to run on PS/SV screen.
- When RUN/STOP DI is disconnected, it stops running and “*dSTOP*” will be displayed.
- When it stops running by means of  key, “*STOP*” will show up.
- When it stops running by means of DI and  Key simultaneously, “*STOP*” will show up.

■ CONTROL ZONE CHANGE

● Without DI OPTION

- According to Zone's value, Control Zone will be decided.

● With DI OPTION

- According to Zone's value, Control Zone will be changed. In addition, you can change ZONE according to ZONE DI(Terminal No. 39–43). How to change ZONE through DI : Firstly select ZONE as terminal no. 40–42. After that you can list ZONT by connecting terminal no. 39–43.

Terminal NO.	ZONE							
	1	2	3	4	5	6	7	8
39 – 40	X	–	X	–	X	–	X	–
39 – 41	X	X	–	–	X	X	–	–
39 – 42	X	X	X	X	–	–	–	–

X : OPEN, – : COSED

■ Auto-tuning

Auto-Tuning calculate the most suitable PID and LBA value automatically and set yp PID and LBA value into each parameter.

● START Auto-Tuning

- Please select all parameters except for PID/LBA.
- Lock level 1 & Lock level 2 should be set up as “0000”.

 www.famcocorp.com

 E-mail: info@famcocorp.com

 @famco_group

 Tel: ۰۲۱-۴۸۰۰۰۰۴۹

 Fax : ۰۲۱ - ۴۴۹۹۶۶۴۲



تهران، کیلومتر ۲۱ بزرگراه لشگری (جاده مخصوص کرج)

روبروی پالایشگاه نفت پارس، پلاک ۱۲

● Operation

CH	PV	If you press  key, parameter which can operate Auto-Tuning will show up as left picture.
1	AT	
1	OFF	
ZONE	SV	



CH	PV	If you press  key one time,  key turns on and off a light. In this time, if your press “  ” key it stops turning on and off a light and then AT ramp will turn on and off a light.
1	AT	
1	ON	
ZONE	SV	

● Cancel Auto-Tuning

If the below conditions happened, Auto-Tuning will be cancelled.



- Burn-out or ADC error on account of broken sensor input cable.
- Auto-Tuning parameter was OFF during Auto-Tuning.
- In case of Power Off
- In case of changing into RUN/STOP mode.

After finishing Auto-Tuning, changed parameters are PB,AR,TI,TD and LBA. If AT is cancelled, controller will be back to the previous PID and LBA value and it starts control. After Auto-Tuning, If control is not working smoothly, please adjust value of PID integral number to meet suitable controller's value.

5 – 2. Batch Setting

This function is used when you want to set same value up from channel 1 to channel 8 in the designated zone.

1 → 2 → 3 → 4 → 5 → 6 → 7 → 8 → A

“A” will be shown om CH display window, “——” will be shown on SV window. At this time, please set set-value up by , ,  key. If you press ENT key, same value will be set up from channel 1 to channel 9.

5 – 3. Alarm

Alarm will act as a “OR” condition against all channels.

(* OR condition : If any channel out of total 8 channels exceeded alarm setting value, alarm output happened)

- Hysterisis against alarm is set up as “ 2 °C
- When setting Wait Alarm, in the below mentioned occasion, waiting movements will be operated.

In case of starting operation for the first time.

In case of changing set value

Set Value was changed due to the change of zone.

• Initial Value & Setting Range in accordance with Alarm Type

Alarm No	Alarm Type	Initial Value	Setting Range
0	No Alarm	-	-
1	Upper limit Alarm hysterisis	EUS (100 %)	EUS (-100~ 100 %)
2	Lower limit Alarm hysterisis	EUS (100 %)	EUS (-100~100 %)
3	Upper & Lower limit Alarm hysterisis	EUS (100 %)	EUS (0 ~ 100 %)
4	Alarm within it range	EUS (0 %)	EUS (0 ~ 100 %)
5	Upper limit hysterisis hold alarm	EUS (100 %)	EUS (-100 ~ 100 %)
6	Lower limit hysterisis hold alarm	EUS (100 %)	EUS (-100 ~ 100 %)
7	Upper&Lower limit hysterisis hold alarm	EUS (100 %)	EUS (0 ~ 100 %)
8	Hold alarm within range	EUS (0 %)	EUS (0 ~ 100 %)
9	Absolute upper limit alarm	EU (100 %)	EU (0 ~ 100 %)
10	Absolute lower limit alarm	EU (0 %)	EU (0 ~ 100 %)
11	Absolute upper limit hold alarm	EU (100 %)	EU (0 ~ 100 %)
12	Absolute lower limit hold alarm	EU (0 %)	EU (0 ~ 100 %)
13	SV upper limit alarm	EU (100 %)	EU (0 ~ 100 %)
14	SV lower limit alarm	EU (0 %)	EU (0 ~ 100 %)
15	LBA/HBA Alarm	-	-
16	FAIL alarm	-	-

※ If you select in Alarm No. 15 in ALT1, LBA Alarm will operate. If you select in Alarm No. 15 in ALT2,3, HBA alarm will operate.

※ HBA alarm could be operated only in case output type is RELAY or SSR output.

※ You can select within its setting range : -1999 ~ 9999

● Alarm operation

· High · Low deviation alarm

Alarm type	Alarm operation
High deviation alarm	
Low deviation alarm	
High · Low deviation alarm value	
Alarm within range	
High absolute alarm	
Low absolute alarm	
High SV alarm	
Low SV alarm	

■ Alarm hysteresis

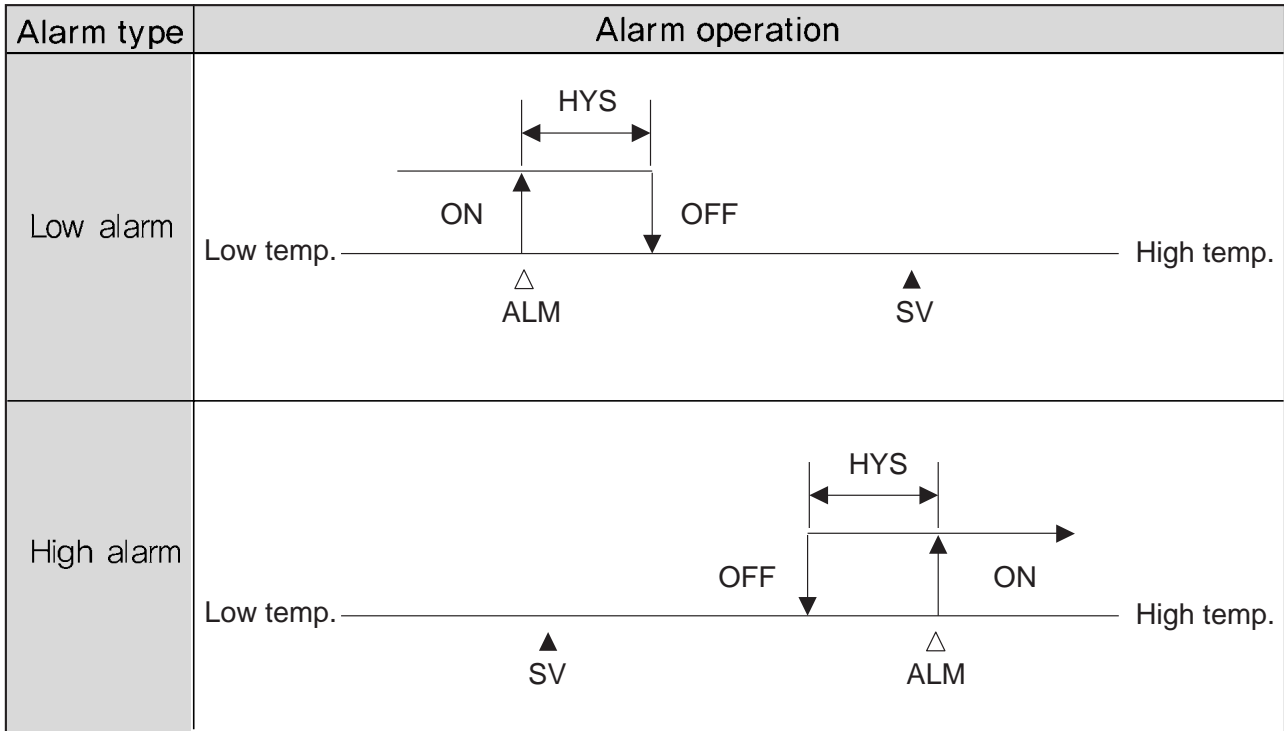

■ Alarm waiting operation

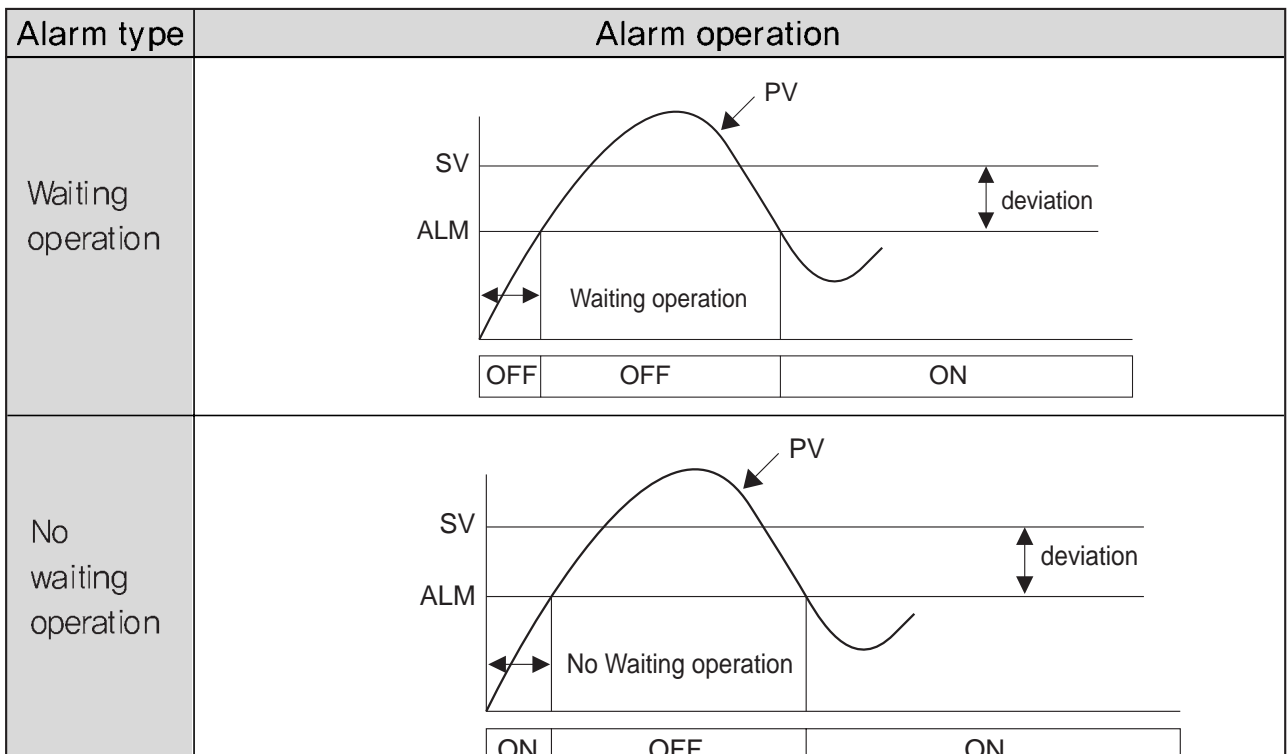

■ LBA (Loop Break Alarm)

If PV value is within P band, LBA does not operate. After it is out of P band, LBA begins to operate.

LBA operation

In case output is 0% and control direction is direct

If PV value is not rising over $2C(2F,2\%)$ within setting time in LBA, it happens.

In case output is 0% and control direction is reverse

If PV value is not falling over $2C(2F,2\%)$ within setting time in LBA, it happens.

In case output is 100% and control direction is direct

If PV value is not falling over $2C(2F,2\%)$ within setting time in LBA, it happens.

In case output is 100% and control direction is reverse

If PV value is not rising over $2C(2F,2\%)$ within setting time in LBA, it happens.

■ LBD (Control Loop Break Alarm Deadband)

- LBD sets Deadband of LBA.
- Although alarm happens, PV is still within LBD as LBA operation. Alarm is not happened in that time.

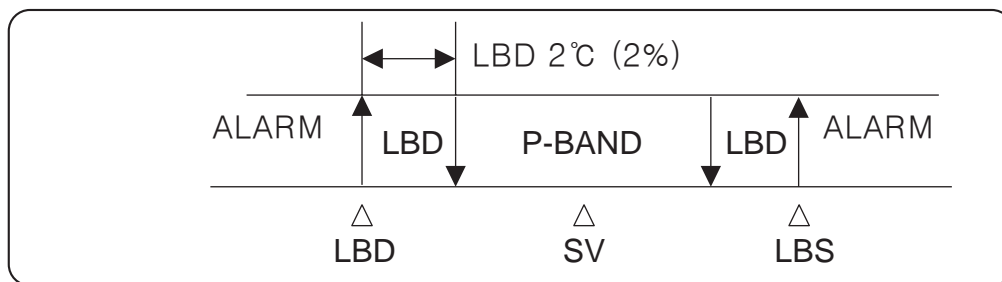

■ HBA (Heater Break Alarm)

- Parameter is displayed by option selection.
- Not used in case of current output
(Available to detect HBA in case Heater output is 0% or 100%).
- HBA consists from CT1 to CT8 as the concept of "OR".
(If CT of any channel is a cause of alarm, alarm is output.)
- Current detection range : 1 ~ 100 A
- Current detection status : $\pm 5\%$ of span
- Current detection resolution : 0.5 A
- Minimum detection time : 200 ms
- Detection method :
 - After output is happened(200ms), measure current by CT.
 - If On time(CT*output%) is not within 200ms in minimum, detection operation is happened.
- Operation method
- In case detected Current value(HBC) in CT is less than Setting value(HBA), HBA alarm operates.

www.famcocorp.com

E-mail: info@famcocorp.com

@famco_group

Tel: ۰۲۱-۴۸۰۰۰۰۴۹

Fax : ۰۲۱ - ۴۴۹۹۴۶۴۲

تهران، کیلومتر ۲۱ بزرگراه لشگری (جاده مخصوص کرج)

روبروی پالایشگاه نفت پارس، پلاک ۱۲

5 – 4. Multi – Memory Zone

There are 8 channels in MC9 and each channel has 8 Memory zone.

Available to recall pre-setting value in Memory zone by changing zone number.

Thus, it is useful in case of continuous work.

For example, you can set 64 values because it is possible that SV is among 8 Memory zones from channel 1 to channel 8.

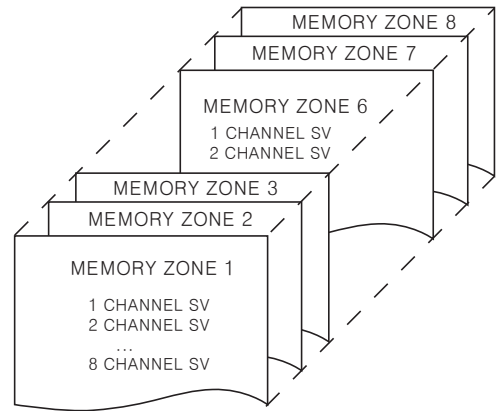

■ Rate Function

This function is to come to target value by inclining under a given time

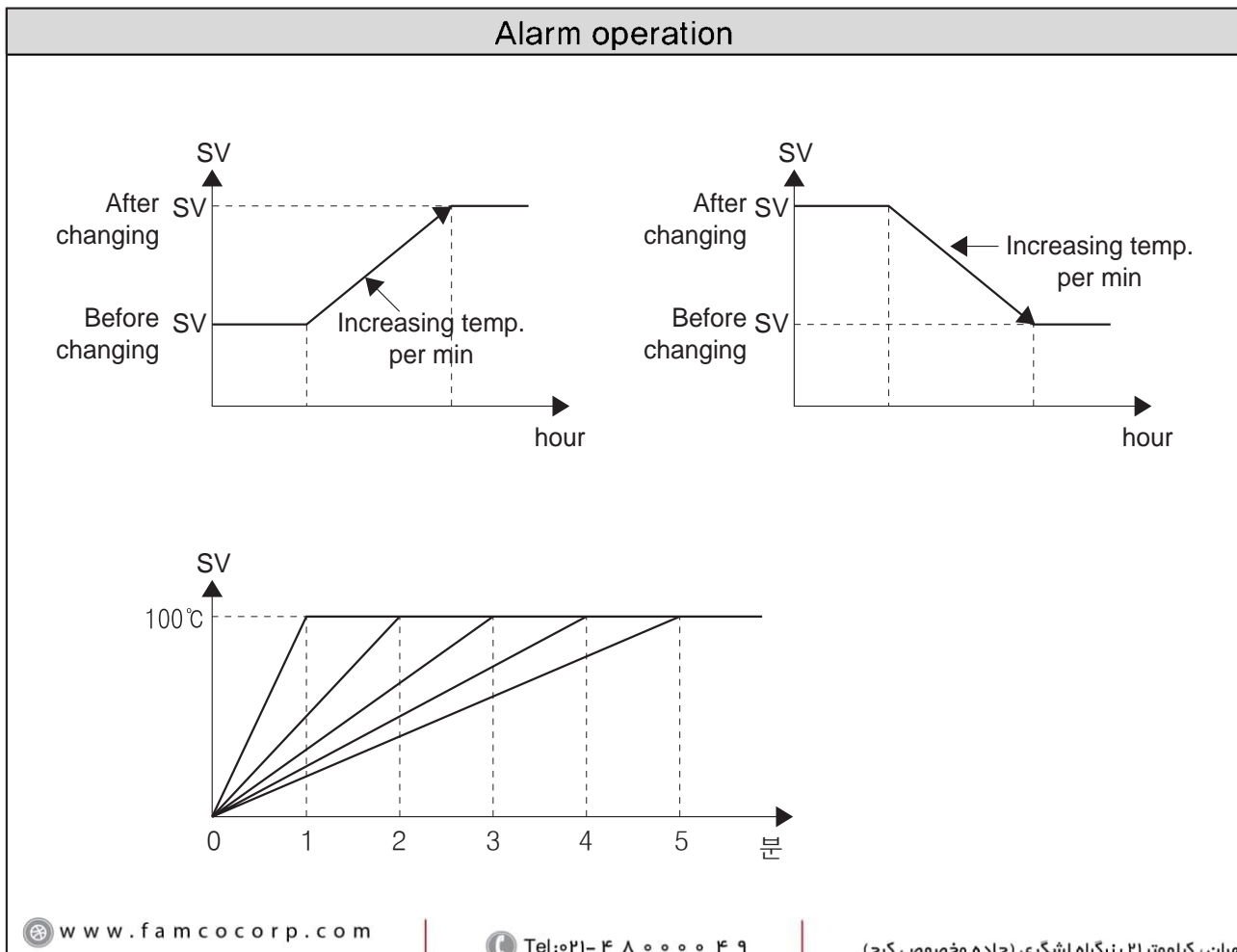

5 – 5. Scan

Set time to display the window of PV/SV from channel 1 to channel 8 one after the other.

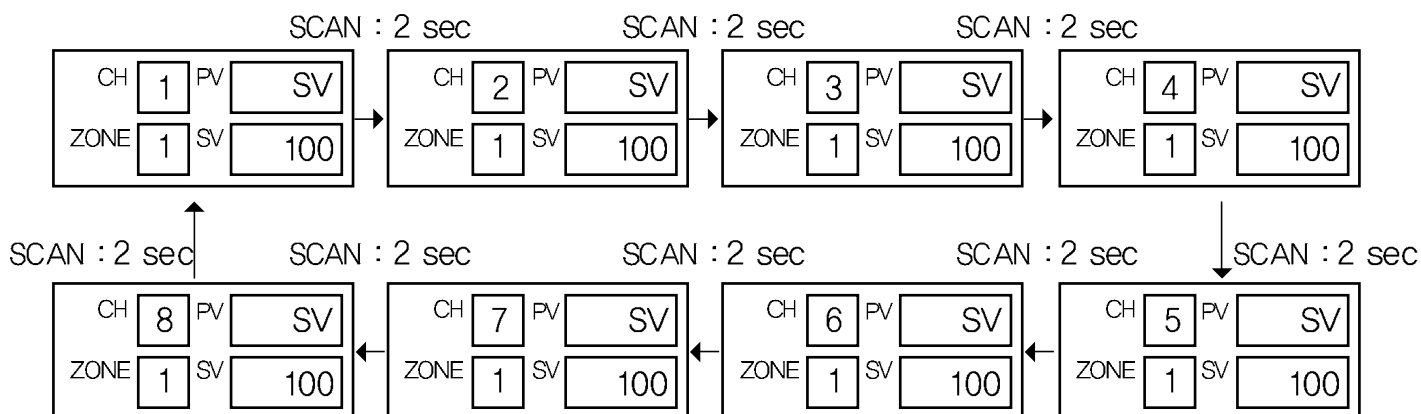

Operation in case of "SCAN" = 2 seconds. It displays each channel by 2 seconds in consecutive order. It displays just from the channel which is being currently displayed in consecutive order.

In case "CHEN = OFF" was set in order not to use channel 2 & channel 6, the channel display is, as follows.

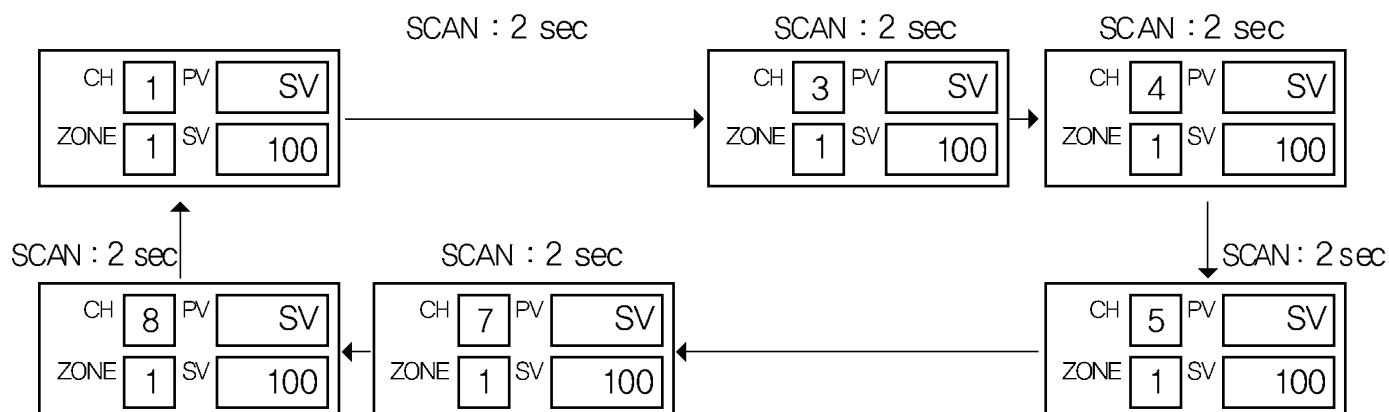

Because channel 2 & channel 6 is in the state of "CHEN = OFF, next channel will be displayed without displaying channel 2 & channel 6. Displaying period: 2 seconds per



5 – 6. Run/Stop

This mode is to operate an instrument after it is finished that initial parameter setting of control

Section		RUN / STOP(by contact input)	
		RUN : Contact is closed	STOP : Contact is opened
RUN/STOP (by key control)	RUN	RUN	<i>d5tP</i>
	STOP	<i>t5tP</i>	<i>5toP</i>

If contact input status is RUN mode, RUN/STOP is selected by key control.

■ Selection of RUN/STOP by key control

- When you change RUN into STOP, please push  key in the state of PV/SV display for 1 sec. It is going to RUN.
- When you change RUN into STOP, character suitable for STOP is displayed in the window of PV if you push  key. It is going to STOP.

Caution

"LOCK 1" is selected by LOCK level 2, RUN/STOP is not possible by key.

■ Selection of RUN/STOP by contact input

According to terminal 37 & terminal 38 are OFF or ON, RUN/STOP is selected.

Terminal number	RUN	STOP
37 – 38	Contact is closed	Contact is opened.

6 SPECIFICATION

6 – 1. Input

• Input & option

Title	Description	
Power voltage	100 – 240 V a.c , 50 – 60 Hz	
Input Type	TC, RTD, DCV (Refer to Input type & Range code)	
Sampling time	1 sec.	
Number of channel	4 channels or 8 channels	
Input resolution	Basically below decimal point of "Measurement range"	
Input impedance	About 1M Ω	
Tolerable signal resistance	About 0.2 μ V / Ω	
Tolerable wiring resistance	About 0.01 % / Ω	
Tolerable input voltage	TC, RTD : 5 V ~ -2 V d.c V : 12.5 V ~ - 5 V	
Standard contact Compensation tolerance	± 1.5 $^{\circ}$ C (0 ~ 50 $^{\circ}$ C)	
Input short detection	Direct control : Down-Scale , Reverse control : Up-Scale	
Measurement range	TC : ± 0.3 % of span RTD : ± 0.3 % of span DCV : ± 0.3 % of span	
Input range	Refer to Input type & Range code	
Isolation Resistance	Measurement terminal & Power terminal : over 20M Ω in 500 V d.c	
Dielectric strength	Power terminal & Measurement terminal: 1 min. in 2300V d.c	
Memory Backup	Memory Backup by EEPROM, Life span of EEPROM: 100,000 writing possible, Save Data for over 10 years	
Control type	ON / OFF, P, PI, PD, PID Control	
Contact input	Direct, Reverse On : less than 2k Ω , Off : over 15k Ω	
HBA	Input	C.T : JS81L : 0 ~ 100 A (J & D Electronic. co. Ltd)
	status	Bigger one between -/+5% of span and -/+2A
Operation environment	Ambient Temp. : 0 ~ 50 $^{\circ}$ C Ambient Humi : 20 ~ 85 % R H	

www.famcocorp.com

E-mail: info@famcocorp.com

@famco_group

Tel: ۰۲۱-۴۸۰۰۰۰۴۹

Fax : ۰۲۱ - ۴۴۹۹۴۶۴۲

تهران، کیلومتر ۲۱ بزرگراه لشگری (جاده مخصوص کرج)

روبروی پالایشگاه نفت پارس، پلاک ۱۲

6 – 2. Output

● Control Output

Items	Description
Relay	Contact : 1a Contact capacity : 250 V a.c, 3 A(Resistive load) Output operation : P.I.D control, On/Off Proportional cycle : 1 ~ 1000 sec. Time resolution : Smaller one between 0.1 % and 10 ms
SSR	On voltage : About 12V d.c min(Resistive load 600Ω min, 30mA limit when short) Off voltage : 0.1 V d.c Max. Proportional cycle : 1 ~ 1000 sec. Output operation : Time proportion Time resolution : Smaller one between 0.1 % and 10ms
SCR	Current output: 0 – 20 mA d.c, 4 – 20 mA d.c Resistive load : less than 600 Ω Status : ± 1 %, of span
TRIAC	220 V a.c, 0.5 A (less than 40C in ambient temp.)

● Alarm Output

Items	Description
Relay Contact	Contact capacity : 240 V a.c, 1A, 30V d.c 1A(Resistive load) Contact : 1a Output point : 3 points max. according to option
HBA/LBA	Point: 1 point Current measure range : a.c 1 ~ 100 A Alarm output is appointed. Alarm type: Refer to 5-3. Alarm Option : Available in case of On/Off control or Proportional output (Not available in case of Current output)

www.famcocorp.com

E-mail: info@famcocorp.com

@famco_group

Tel: ۰۲۱-۴۸۰۰۰۰۰۴۹

Fax : ۰۲۱ - ۴۴۹۹۴۶۴۲

تهران، کیلومتر ۲۱ بزرگراه لشگری (جاده مخصوص کرج)

روبروی پالایشگاه نفت پارس، پلاک ۱۲

6 – 3. Communication

Application Standard	Based on EIA RS485
Max. Contact Points	31 points or 255 points
Communication Method	2 Wire half duplex or 4 Wire half duplex
Synchronization	Start–Stop synchronous Mode
Communication Sequence	None
Communication Distance	1.2Km max.
Communication Speed	1200/2400/4800/9600 bps(Speed is changeable by Parameter)
start bit	1 bit
data bit	7 or 8 bit
parity bit	None, Even numbers, Odd numbers
stop bit	1 or 2 bit
protocol	PC link without SUM(0), Pc link with SUM(1)
response time	Reception treatment time + (Response time × 10 ms)

6 – 4. Error Code

Display	Caution	PV window	Measure & Control condition
<i>obr</i> <i>-obr</i>	PV value exceeds input range	OVR: Displays current PV value to EU(105%) in turn. OVR: Displays current PV value to EU(-5%) in turn.	Measure: Check PV value Output status : Normal operation PV status: Normal operation
<i>rjc</i>	RJC error happens	Displays PV value, not including RJC value.	Measure: POWER OFF→ON Output status : Normal operation PV status: Normal operation
<i>EEP</i>	EEPROM error happens	Displays current PV value. Displays BOUT	Measure: POWER OFF→ON Output status : Normal operation PV status: Normal operation
<i>boUt</i>	Input sensor is out of order or PV value exceeds EU(-5~105%)	BOUT	Measure: Check Input sensor or PV value. Output status : Direct (100%), Reverse(0%) PV status: less than Direct(0%), over Reverse(100%)
<i>AdC</i>	AD converter is out of over.	ADC	Measure: POWER OFF→ON If it is not returned to normal, please contact our agent in near or speak to a customer service representative of main office. Output status : Direct (100%), Reverse(0%) PV status: less