

**THREE SPEEDS THREE PHASE CIRCULATING PUMP**

**Applications**

The SISTEMA UPRF circulators for clean liquids, without abrasives, which are non-aggressive for the pump materials (contents of solids up to 0.2%). For heating, conditioning, cooling and circulation plants. For civil and industrial applications. When low noise operation is required.

**Limits of application**

- Liquid temperature from -10 °C to +120 °C (in short-time duty up to + 140 °C).
- Ambient temperature up to 40 °C.
- Maximum glycol quantity: 50% (Mixture with more than 20% glycol content require rechecking of the pumping data).
- Maximum permissible working pressure 6/10 bar.

**Motor**

- 2/4 pole induction motor, 50 Hz.
- Three adjustable speeds.
- UPRF: three-phase 400 V.
- Insulation class F.
- Protection IP 43.

**Components**

- Pump casing Cast iron
- Impeller Stainless steel
- Shaft Stainless steel

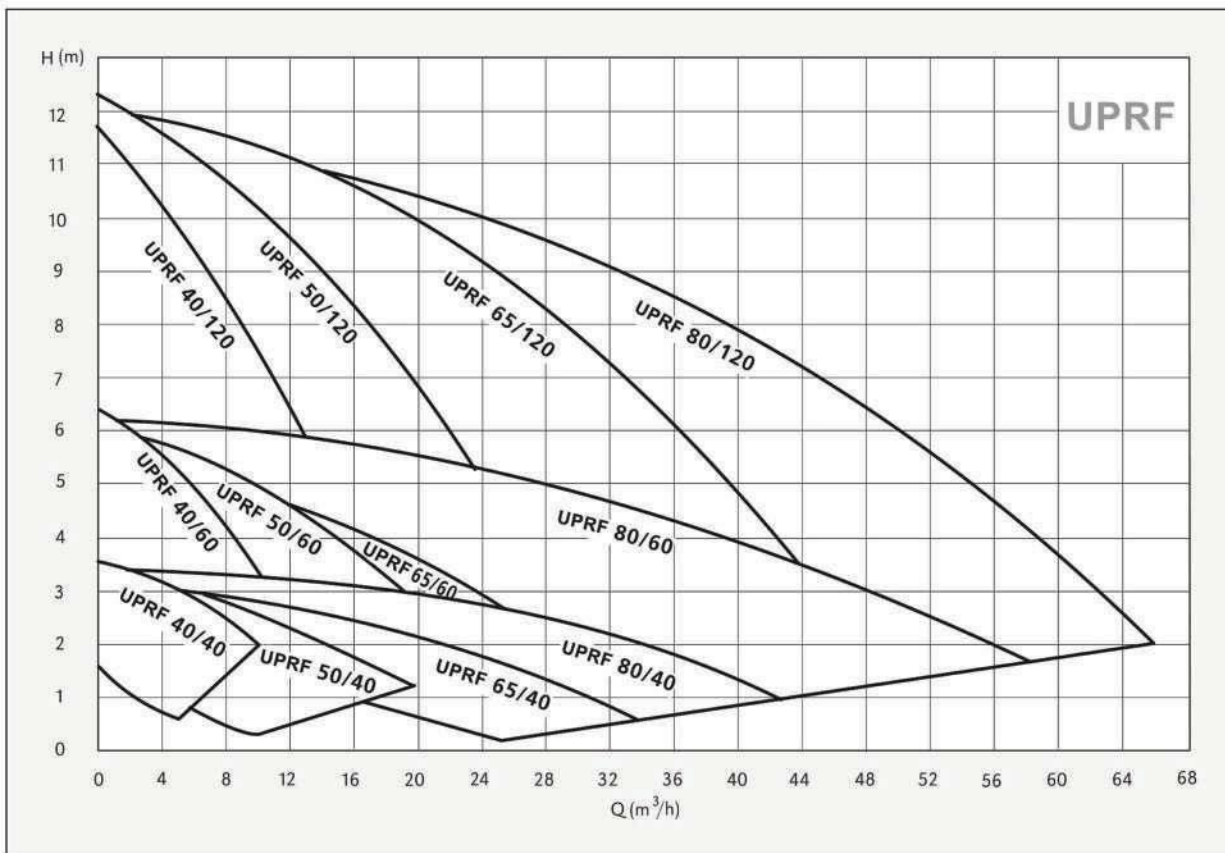

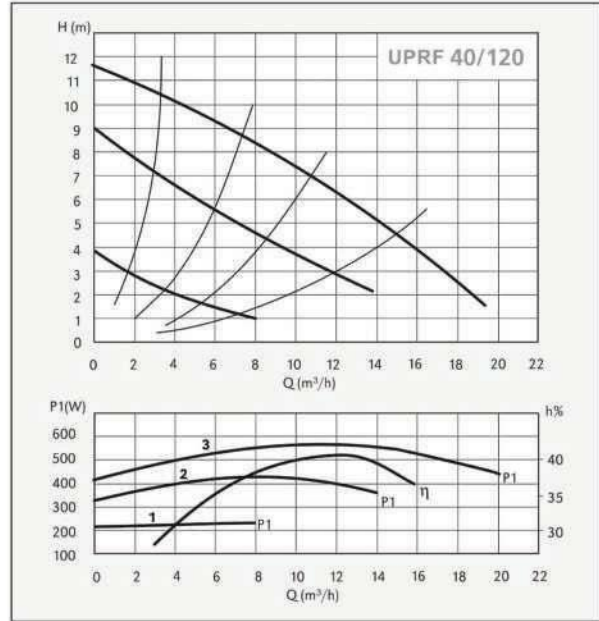
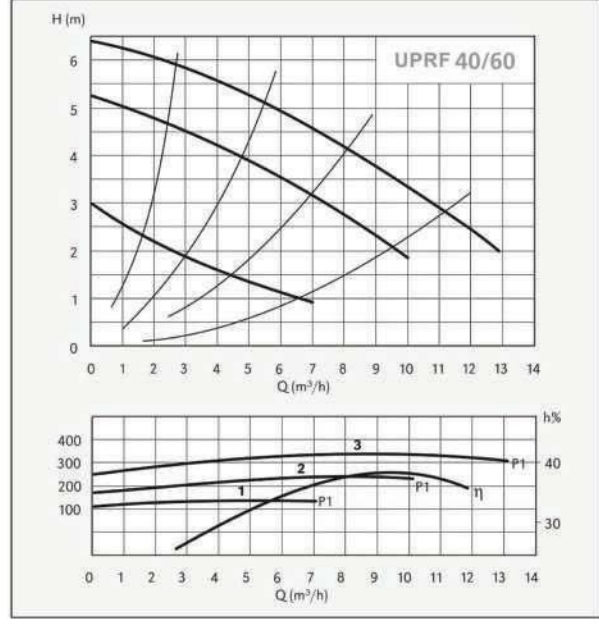
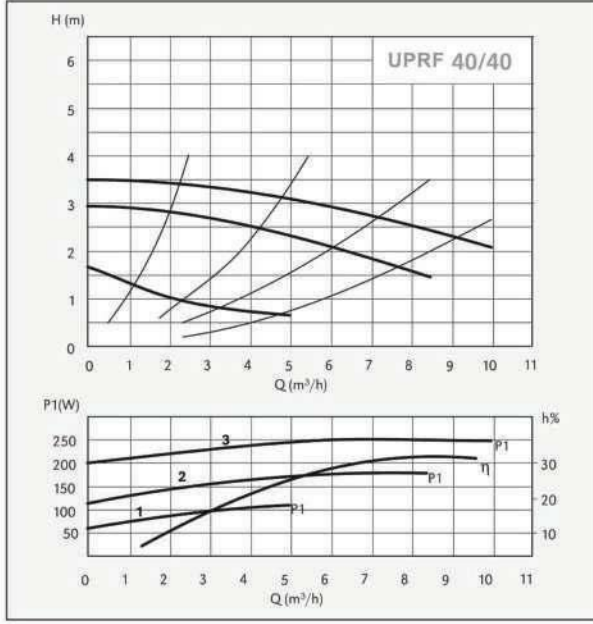

**DIMENSIONS AND WEIGHTS**

TYPE	DN	N° Pole		Pos.	1/min	P1 (W)	3x 400 V [A]	[kg]
		2	4					
UPRF 40-40/250	40	✓		3	1440	240	0,76	17,0
				2	1200	160	0,24	
				1	660	100	0,11	
UPRF 40-60/250	40	✓		3	2790	320	0,74	17,5
				2	2240	240	0,36	
				1	1440	140	0,18	
UPRF 40-120/250	40	✓		3	2820	560	1,16	19,0
				2	2200	400	0,64	
				1	1250	220	0,26	

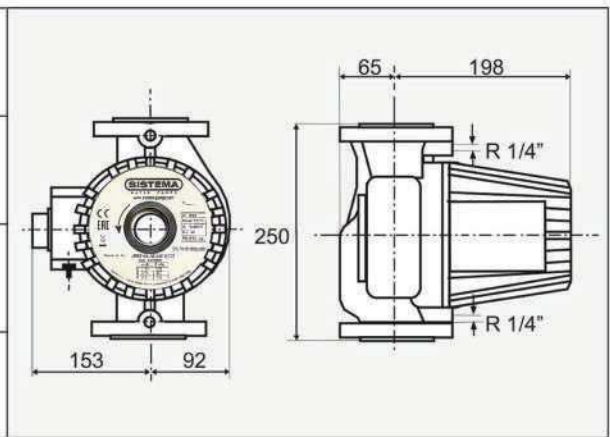

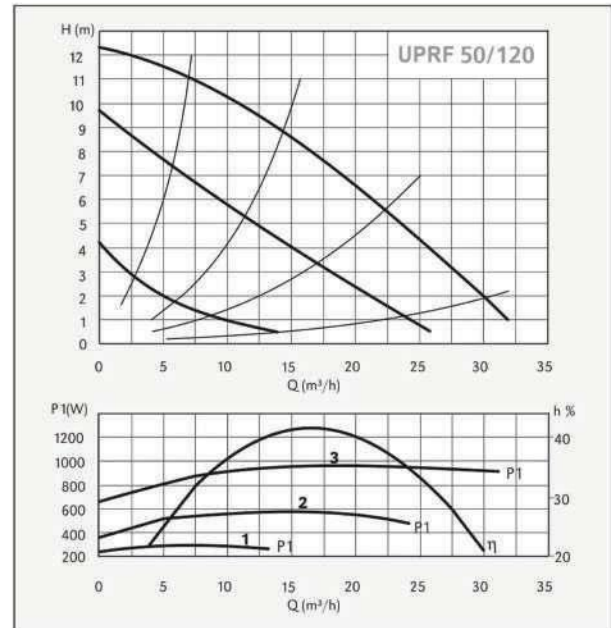
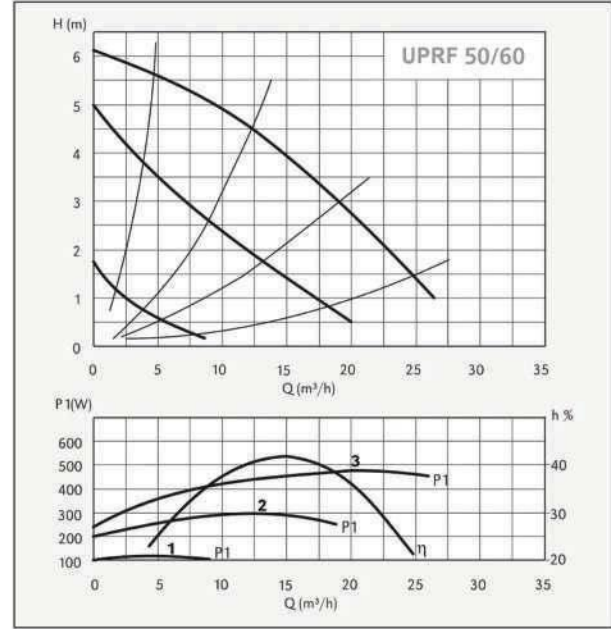
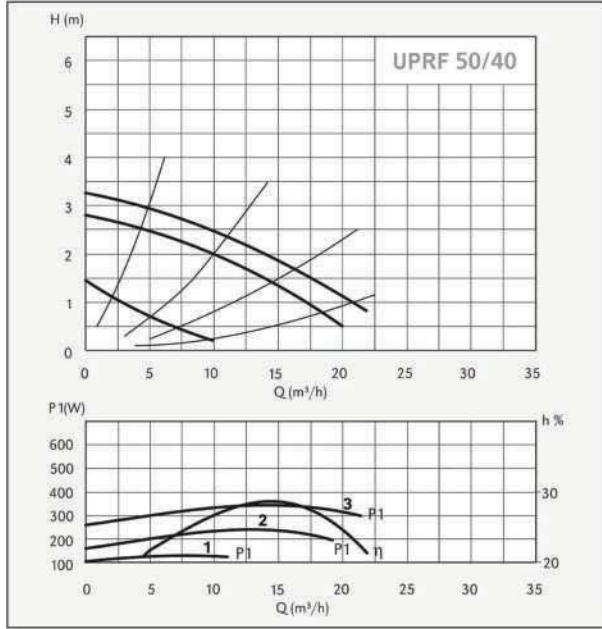

**DIMENSIONS AND WEIGHTS**

TYPE	DN	N° Pole		Pos.	1/min	P1 (W)	3x 400 V [A]	[kg]
		2	4					
UPRF 50-40/280	50	✓		3	1450	340	1,05	24,0
				2	1220	240	0,44	
				1	620	120	0,22	
UPRF 50-60/280	50	✓		3	1400	470	1,15	24,0
				2	1000	300	0,55	
				1	560	100	0,20	
UPRF 50-120/280	50	✓		3	2800	950	1,73	24,0
				2	2330	540	1,05	
				1	1270	265	0,46	

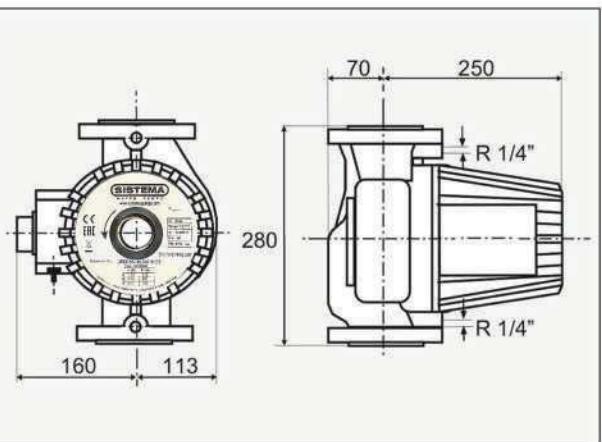

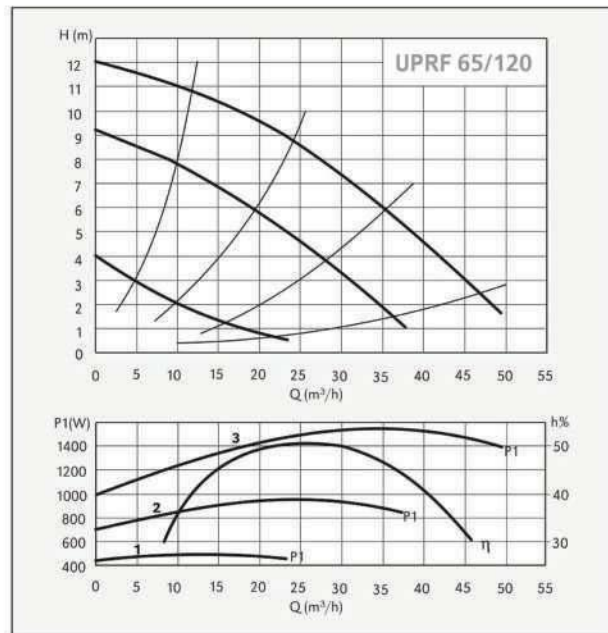
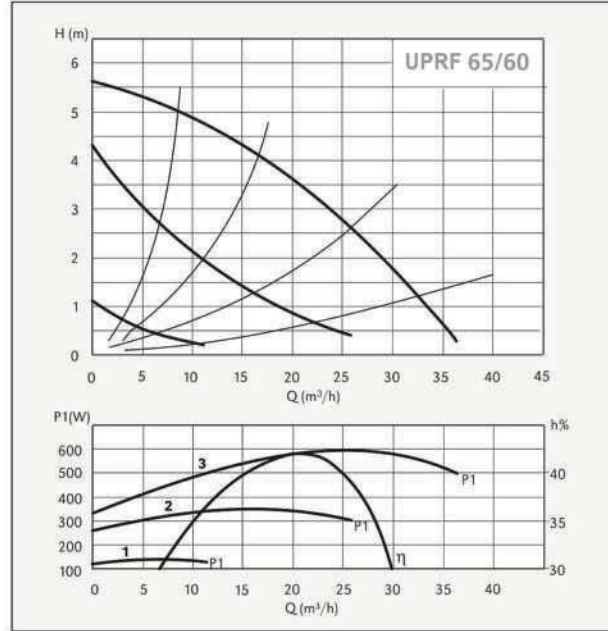
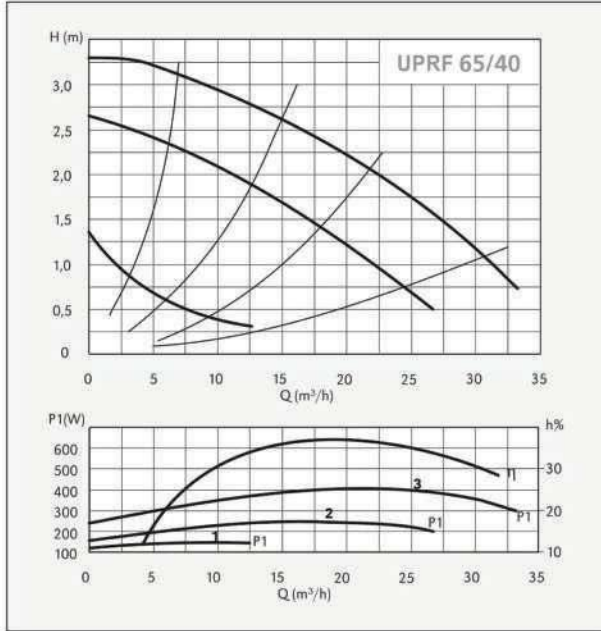

**DIMENSIONS AND WEIGHTS**

TYPE	DN	N° Pole		Pos.	1/min	P1 (W)	3x 400 V [A]	[kg]	
		2	4						
UPRF 65-40/340	65	✓		3	1430	400	1,10	29,0	
				2	1150	260	0,50		
				1	600	120	0,22		
UPRF 65-60/340	65	✓		3	1370	600	1,25	29,0	
				2	950	360	0,64		
				1	450	120	0,22		
UPRF 65-120/340	65	✓		3	2810	1560	2,80	31,0	
				2	2200	960	1,70		
				1	1250	460	0,84		

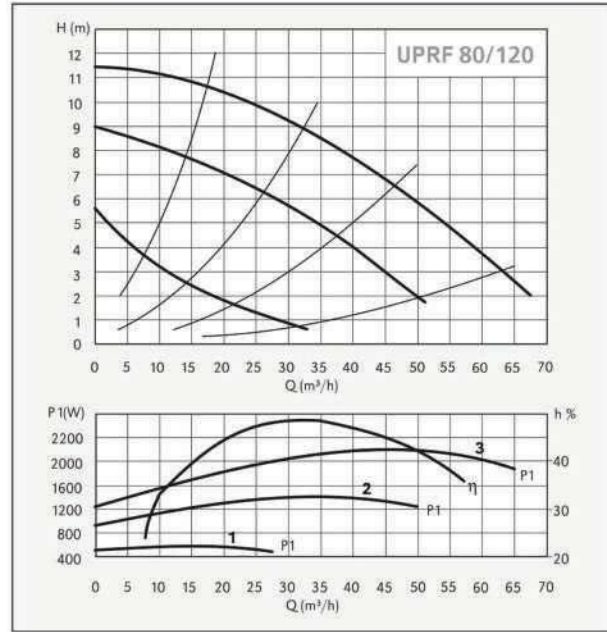
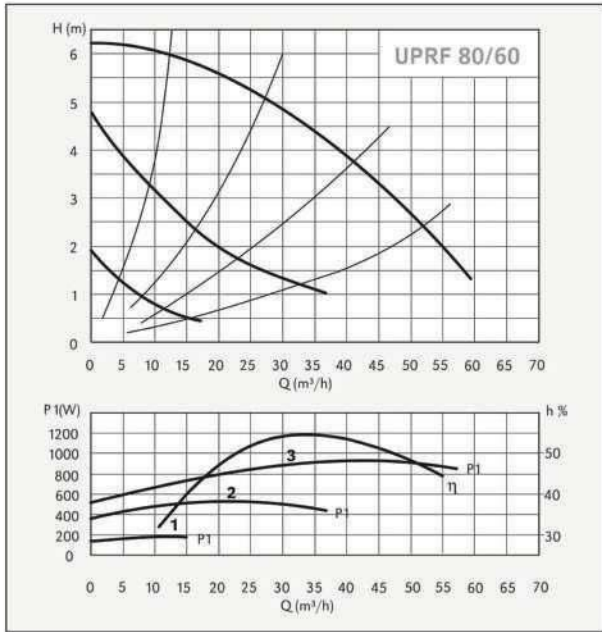

**DIMENSIONS AND WEIGHTS**

TYPE	DN	N° Pole		Pos.	1/min	P1 (W)	3x 400 V [A]	[kg]	
		2	4						
UPRF 80-60/360	80	✓		3	1350	690	2,20	33,5	
				2	1000	560	1,10		
				1	600	200	0,38		
UPRF 80-120/360	80	✓		3	2800	2200	3,80	34,5	
				2	2160	1400	2,40		
				1	1200	550	1,05		