

INSTRUCTION MANUAL

TECO INVERTER

**380V级: 0.75~220kW
(1~300HP)**



TECO INVERTER T310 Series



TAIAN TECHNOLOGY (WUXI) CO., LTD.

Add: Wuxi High&New Technology Industry
Development Zone. Block 65-C ,WuXi,
Jiangsu ,China.

Postcode: 214028

Tel: +86-510-85227555

Fax: +86-510-85227556(Electronic)

Website: www.taian-technology.com

Distributor

VER: 01 2017.6

料号: 4KA72X668W01

This manual may be modified when necessary because of improvement of the product, modification, or changes in specification, this manual is subject to change without notice.

Table of Contents

Preface	0-1
Chapter 1 Safety Precautions	1-1
1.1 Before Supplying Power to the Inverter.....	1-1
1.2 Wiring	1-2
1.3 Before Operation	1-3
1.4 Parameters Setting.....	1-3
1.5 Operation.....	1-4
1.6 Maintenance, Inspection and Replacement	1-5
1.7 Disposal of the Inverter	1-5
Chapter 2 Model Description	2-1
2.1 Nameplate Data.....	2-1
2.2 Model Identification.....	2-2
Chapter 3 Environment and Installation	3-1
3.1 Environment	3-1
3.2 Installation	3-3
3.2.1 Installation space	3-3
3.2.2 Outline dimension and caution	3-3
3.2.3 Product Dismounting.....	3-7
3.3 Wiring Peripheral Power Devices.....	3-11
3.4 Power Terminals.....	3-15
3.5 Input / Output Power Section Block Diagram.....	3-19
3.6 Power Input Wire Size, NFB and MCB Part Numbers	3-20
3.7 Inverter Specifications	3-23
3.8 Overall Dimension drawing	3-29
Chapter 4 Keypad and Programming Functions	4-1
4.1 LED Keypad	4-1
4.1.1 Keypad Display and Keys	4-1
4.1.2 Seven Segment Display Description	4-2
4.1.3 LED Indicator Description	4-4
4.1.4 Power-up Monitor.....	4-5
4.1.5 Modifying Parameters/ Set Frequency Reference.....	4-6
4.1.6 Operation Control.....	4-8
4.2 Parameters	4-9
4.3 Description of Parameters.....	4-59

4.4 Modbus Protocol Descriptions.....	4-236
4.4.1 Communication Connection and Data Frame.....	4-236
4.4.2 Register and Data Format.....	4-240
4.4.3 Parameter Data.....	4-249
Chapter 5 Troubleshooting and Fault Diagnostics	5-1
5.1 General	5-1
5.2 Fault Detection Function.....	5-1
5.3 Warning / Self-diagnosis Detection Function.....	5-5
5.4 Auto-tuning Error.....	5-13
Chapter 6 Inverter Peripheral devices and Options.....	6-1
6.1 Braking Resistors and Braking Units	6-1
6.2 AC Line Reactors.....	6-2
6.3 Input Noise Filters	6-3
6.4 Input Current and Fuse Specifications	6-4
6.5 Other Options.....	6-5
6.6 Communication Options	6-8
Appendix A: Communication Networks	A-1
A1.1 RS485-- Network (Modbus)	A-1
A1.2 Profibus DP Network.....	A-2
Appendix B: Name and content of hazardous substances in products	B-1
Appendix C: EMI Configuration	C-1

Preface

The T310 product is an inverter designed to control a three-phase induction motor. Please read this manual carefully to ensure correct operation, safety and to become familiar with the inverter functions.

The T310 inverter is an electrical / electronic product and must be installed and handled by qualified service personnel.

Improper handling may result in incorrect operation, shorter life cycle, or failure of this product as well as the motor.



All T310 documentation is subject to change without notice. Be sure to obtain the latest editions for use or visit our website at <http://globalsa.teco.com.tw>



Available Documentation:

1. T310 Instruction Manual

Ensure you have sound knowledge of the device and familiarize yourself with all safety information and precautions before proceeding to operate the inverter.

Ensure you have sound knowledge of the inverter and familiarize yourself with all safety information and precautions before proceeding to operate the inverter.

Please pay close attention to the safety precautions indicated by the warning  and caution  symbol.

 Warning	Failure to ignore the information indicated by the warning symbol may result in death or serious injury.
 Caution	Failure to ignore the information indicated by the caution symbol may result in minor or moderate injury and/or substantial property damage.

Chapter 1 Safety Precautions

1.1 Before Supplying Power to the Inverter



Warning

The main circuit must be correctly wired. For three phase supply use input terminals (R/L1, S/L2, T/L3). Terminals U/T1, V/T2, W/T3 must only be used to connect the motor. Connecting the input supply to any of the U/T1, V/T2 or W/T3 terminals will cause damage to the inverter.



Caution

- To avoid the front cover from disengaging or other physical damage, do not carry the inverter by its cover. Support the unit by its heat sink when transporting. Improper handling can damage the inverter or injure personnel, and should be avoided.
- To avoid the risk of fire, do not install the inverter on or near flammable objects. Install on nonflammable objects such as metal surfaces.
- If several inverters are placed inside the same control panel, provide adequate ventilation to maintain the temperature below 40°C/104°F to avoid overheating or fire.
- When removing or installing the digital operator, turn off the power first, and then follow the instructions in this manual to avoid operator error or loss of display caused by faulty connections.



Warning

- This product is sold subject to IEC 61800-3. In a domestic environment this product may cause radio interference in which case the user may need to apply corrective measures.
- Motor over temperature protection is provided.

1.2 Wiring



Warning

- Always turn OFF the power supply before attempting inverter installation and wiring of the user terminals.
- Wiring must be performed by a qualified personnel / certified electrician.
- Make sure the inverter is properly grounded. 380V Class: Grounding impedance shall be less than 10Ω.
- Make sure the inverter is properly grounded. It is required to disconnect the ground wire in the control board to avoid the sudden surge causing damage on electronic parts if it is improperly grounded.
- RCD is required to be in compliance with the protection norm of B-type leakage current.
- Please check and test emergency stop circuits after wiring. (Installer is responsible for the correct wiring.)
- Never touch any of the input or output power lines directly or allow any input of output power lines to come in contact with the inverter case.
- Do not perform a dielectric voltage withstand test (megger) on the inverter this will result in inverter damage to the semiconductor components.



Caution

- The line voltage applied must comply with the inverter's specified input voltage. (See product nameplate section 2.1)
- Connect braking resistor and braking unit to the designated terminals. (See section 3.3)
- Do not connect a braking resistor directly to the DC terminals P (+) and N (-), otherwise fire may result.
- Use wire gauge recommendations and torque specifications. (See Wire Gauge and Torque Specification in section 3.6)
- Never connect input power to the inverter output terminals U/T1, V/T2, W/T3.
- Do not connect a contactor or switch in series with the inverter and the motor.
- Do not connect a power factor correction capacitor or surge suppressor to the inverter output.
- Ensure the interference generated by the inverter and motor does not affect peripheral devices.

1.3 Before Operation



Warning

- Make sure the inverter capacity matches the parameters 13-00.
- Reduce the carrier frequency (parameter 11-01) If the cable from the inverter to the motor is greater than 80 ft (25m). A high-frequency current can be generated by stray capacitance between the cables and result in an overcurrent trip of the inverter, an increase in leakage current, or an inaccurate current readout.
- Be sure to install all covers before turning on power. Do not remove any of the covers while power to the inverter is on, otherwise electric shock may occur.
- Do not operate switches with wet hands, otherwise electric shock may result.
- Do not touch inverter terminals when energized even if inverter has stopped, otherwise electric shock may result.

1.4 Parameters Setting



Caution

- Do not connect a load to the motor while performing a rotational auto-tune.
- Make sure the motor can freely run and there is sufficient space around the motor when performing a rotational auto-tune.

1.5 Operation



Warning

- Be sure to install all covers before turning on power. Do not remove any of the covers while power to the inverter is on, otherwise electric shock may occur.
- Do not connect or disconnect the motor during operation. This will cause the inverter to trip and may cause damage to the inverter.
- Operations may start suddenly if an alarm or fault is reset with a run command active. Confirm that no run command is active upon resetting the alarm or fault, otherwise accidents may occur.
- Do not operate switches with wet hands, otherwise electric shock may result.
- It provides an independent external hardware emergency switch, which emergently shuts down the inverter output in the case of danger.
- If automatic restart after power recovery (parameter 07-00) is enabled, the inverter will start automatically after power is restored.
- Make sure it is safe to operate the inverter and motor before performing a rotational auto-tune.
- Do not touch inverter terminals when energized even if inverter has stopped, otherwise electric shock may result.
- Do not check signals on circuit boards while the inverter is running.
- After the power is turned off, the cooling fan may continue to run for some time.



Caution

- Do not touch heat-generating components such as heat sinks and braking resistors.
- Carefully check the performance of motor or machine before operating at high speed, otherwise Injury may result.
- Note the parameter settings related to the braking unit when applicable.
- Do not use the inverter braking function for mechanical holding, otherwise injury may result.
- Do not check signals on circuit boards while the inverter is running.

1.6 Maintenance, Inspection and Replacement



Warning

- To avoid feeling of power. At least five minutes after the power is turned OFF, DC capacitors in the inverter will be discharged completely. Please wait for five minutes after power has been turned OFF, and then disassemble or inspect the inverter. Wait a minimum of 15 minutes while inverter is over 15HP.
- Wait a minimum of five minutes after power has been turned OFF before starting an inspection. Also confirm that the charge light is OFF and that the DC bus voltage has dropped below 25Vdc.
- Never touch high voltage terminals in the inverter.
- Make sure power to the inverter is disconnected before disassembling the inverter.
- Only authorized personnel should perform maintenance, inspection, and replacement operations. (Take off metal jewelry such as watches and rings and use insulated tools.)



Caution

- The Inverter can be used in an environment with a temperature range from 14° ~104(140) °F (-10~+40(60)°C) and relative humidity of 95% non-condensing.
- The inverter must be operated in a dust, gas, mist and moisture free environment.

1.7 Disposal of the Inverter



Caution

- Please dispose of this unit with care as an industrial waste and according to your required local regulations.
- The capacitors of inverter main circuit and printed circuit board are considered as hazardous waste and must not be burned.
- The Plastic enclosure and parts of the inverter such as the top cover board will release harmful gases if burned.

Chapter 2 Model Description

2.1 Nameplate Data

It is essential to verify the T310 inverter nameplate and make sure that the T310 inverter has the correct rating so it can be used in your application with the proper sized AC motor.

Unpack the T310 inverter and check the following:

- (1) The T310 inverter and start-up and installation manual are contained in the package.
- (2) The T310 inverter has not been damaged during transportation there should be no dents or parts missing.
- (3) The T310 inverter is the type you ordered. You can check the type and specifications on the main nameplate.
- (4) Check that the input voltage range meets the input power requirements.
- (5) Ensure that the motor HP matches the motor rating of the inverter.

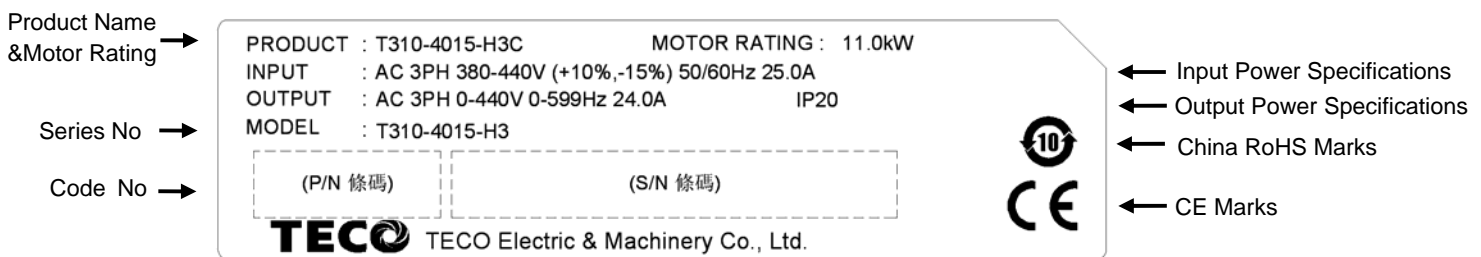

2.2 Model Identification

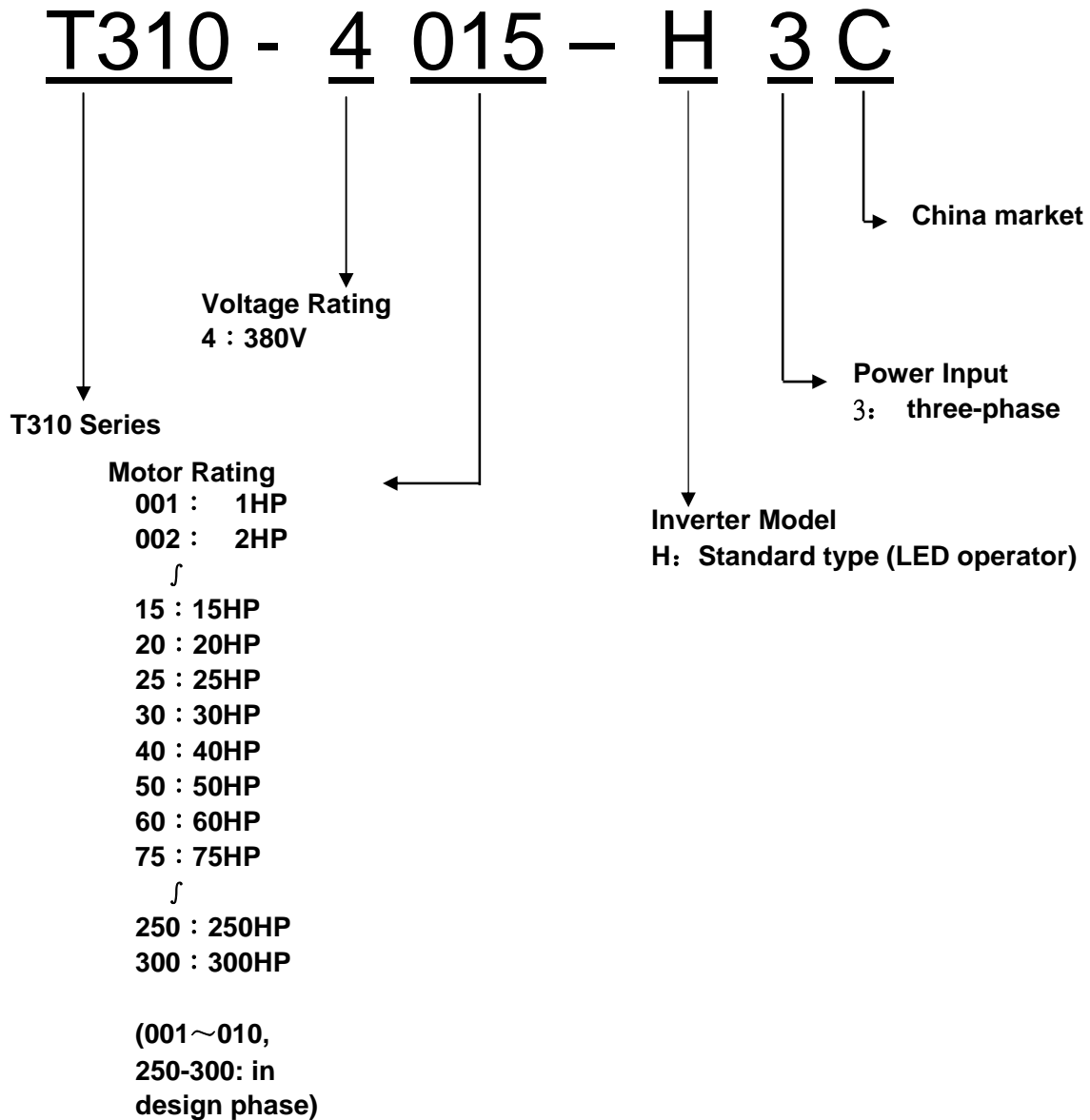

Inverter Models:

Inverter Model (Standard Model)	Applied Voltage (Vac)	Applied Frequency (Hz)	Horse Power (HP)	Applied Motor (kW)	Filter Built-in		Dimension (mm) W×H×D	Frame
					With	Without		
T310-4015-H3C	380~440V 3 Ø (+10%/-15%)	50/60Hz	15	11		⊙	215*315*212	3
T310-4020-H3C			20	15		⊙	215*315*212	3
T310-4025-H3C			25	18.5		⊙	256*378*234	4
T310-4030-H3C			30	22		⊙	256*378*234	4
T310-4040-H3C			40	30		⊙	284*535*270	5
T310-4050-H3C			50	37		⊙	284*535*270	5
T310-4060-H3C			60	45		⊙	323*575*292	6
T310-4075-H3C			75	55		⊙	323*575*292	6
T310-4100-H3C			100	75		⊙	344*580*315	7
T310-4125-H3C			125	90		⊙	344*580*315	7
T310-4150-H3C			150	110		⊙	459*790*333	8
T310-4175-H3C			175	132		⊙	459*790*333	8
T310-4215-H3C			215	160		⊙	459*790*333	8

Note:

- . Short Circuit Rating: 5kA
- . Frame 3~4: reserve external DCL terminal; Frame 5~8: built-in DCL.
- . 1~10HP, 250~300HP: in design phase

Chapter 3 Environment and Installation

3.1 Environment

The environment will directly affect the proper operation and the life span of the inverter. To ensure that the inverter will give maximum service life, please comply with the following environmental conditions:

Protection	
Protection Class	IP20,IP00
Operating Temperature	Ambient Temperature: $-10^{\circ}\text{C} \sim +40^{\circ}\text{C}$ (IP20), $-10^{\circ}\text{C} \sim +50^{\circ}\text{C}$ (IP00), but maximally derate up to 60°C (can derate only above 40°C). When several inverters are parallel installed in the panel, please pay attention to the position for heat removal.
Storage Temperature	$-20^{\circ}\text{C} - +70^{\circ}\text{C}$ ($-4 - 158^{\circ}\text{F}$)
Humidity	95% non-condensing Relative humidity 5% to 95%, free of moisture. (Follow IEC60068-2-78 standard)
Altitude	Altitude: Below 1000 m (3281 ft.) It is required to derate 1% of current at each additional 100 m. The maximum altitude is 3000 m .
Installation Site	Avoid exposure to rain or moisture.
	Avoid direct sunlight.
	Avoid oil mist and salinity.
	Avoid corrosive liquid and gas.
	Avoid dust, lint fibers, and small metal filings.
	Keep away from radioactive and flammable materials.
	Avoid electromagnetic interference (soldering machines, power machines).
Avoid vibration (stamping, punching machines etc.). Add a vibration-proof pad if the situation cannot be avoided.	
Shock	Maximum acceleration: 1.0G (9.8m/s^2), from 49.84 to 150 Hz Displacement amplitude : 0.3mm (peak value), from 10 to 49.84 Hz (Follow IEC60068-2-6 standard)

Tightening torque on terminal block

For safety, when the main circuit terminal is wired, recommend to use copper wires (rated at 75°C) approved by UL, and specified circular crimp terminals as below table (conform to UL standard). Recommend to use crimp terminals manufactured by NICHIFU as below, and please use the crimp tooling recommended by terminal supplier to crimp terminals and insulating sleeves.

Wire Gauge mm ² (AWG)	Terminal Screw Spec.	Circular Crimp Terminal Model	Tightening Torque kgf.cm (in.lbs)	Insulating sleeve Model	Crimp Tooling Model
0.75 (18)	M3.5	R1.25-3.5	8.2 to 10 (7.1 to 8.7)	TIC 1.25	NH 1
	M4	R1.25-4	12.2 to 14 (10.4 to 12.1)	TIC 1.25	NH 1
1.25 (16)	M3.5	R1.25-3.5	8.2 to 10 (7.1 to 8.7)	TIC 1.25	NH 1
	M4	R1.25-4	12.2 to 14 (10.4 to 12.1)	TIC 1.25	NH 1
2 (14)	M3.5	R2-3.5	8.2 to 10 (7.1 to 8.7)	TIC 2	NH 1 / 9
	M4	R2-4	12.2 to 14 (10.4 to 12.1)	TIC 2	NH 1 / 9
	M5	R2-5	22.1 to 24 (17.7 to 20.8)	TIC 2	NH 1 / 9
	M6	R2-6	25.5 to 30.0 (22.1 to 30.0)	TIC 2	NH 1 / 9
3.5/5.5 (12/10)	M4	R5.5-4	12.2 to 14 (10.4 to 12.1)	TIC 3.5/5.5	NH 1 / 9
	M5	R5.5-5	20.4 to 24 (17.7 to 20.8)	TIC 3.5/5.5	NH 1 / 9
	M6	R5.5-6	25.5 to 30.0 (22.1 to 30.0)	TIC 3.5/5.5	NH 1 / 9
	M8	R5.5-8	61.2 to 66.0 (53.0 to 66.0)	TIC 3.5/5.5	NH 1 / 9
8 (8)	M4	R8-4	12.2 to 14 (10.4 to 12.1)	TIC 8	NOP 60
	M5	R8-5	20.4 to 24 (17.7 to 20.8)	TIC 8	NOP 60
	M6	R8-6	25.5 to 30.0 (22.1 to 30.0)	TIC 8	NOP 60
	M8	R8-8	61.2 to 66.0 (53.0 to 66.0)	TIC 8	NOP 60
14 (6)	M4	R14-4	12.2 to 14 (10.4 to 12.1)	TIC 14	NH 1 / 9
	M5	R14-5	20.4 to 24 (17.7 to 20.8)	TIC 14	NH 1 / 9
	M6	R14-6	25.5 to 30.0 (22.1 to 30.0)	TIC 14	NH 1 / 9
	M8	R14-8	61.2 to 66.0 (53.0 to 66.0)	TIC 14	NH 1 / 9
22 (4)	M6	R22-6	25.5 to 30.0 (22.1 to 30.0)	TIC 22	NOP 60/ 150H
	M8	R22-8	61.2 to 66.0 (53.0 to 66.0)	TIC 22	NOP 60/ 150H
30/38 (3 / 2)	M6	R38-6	25.5 to 30.0 (22.1 to 30.0)	TIC 38	NOP 60/ 150H
	M8	R38-8	61.2 to 66.0 (53.0 to 66.0)	TIC 38	NOP 60/ 150H
50 / 60 (1 / 1/ 0)	M8	R60-8	61.2 to 66.0 (53.0 to 66.0)	TIC 60	NOP 60/ 150H
	M10	R60-10	102 to 120 (88.5 to 104)	TIC 60	NOP 150H
70 (2/0)	M8	R70-8	61.2 to 66.0 (53.0 to 66.0)	TIC 60	NOP 150H
	M10	R70-10	102 to 120 (88.5 to 104)	TIC 60	NOP 150H
80 (3/0)	M10	R80-10	102 to 120 (88.5 to 104)	TIC 80	NOP 150H
	M16	R80-16	255 to 280 (221 to 243)	TIC 80	NOP 150H
100 (4/0)	M10	R100-10	102 to 120 (88.5 to 104)	TIC 100	NOP 150H
	M12	R100-12	143 to 157 (124 to 136)	TIC 100	NOP 150H
	M16	R80-16	255 to 280 (221 to 243)	TIC 80	NOP 150H

3.2 Installation

3.2.1 Installation space

(1) Please install the T310 inverter in vertical direction, leaving enough space to ensure the cooling effect, shown in Fig3.1.

Avoid the upside-down or horizontal installation.

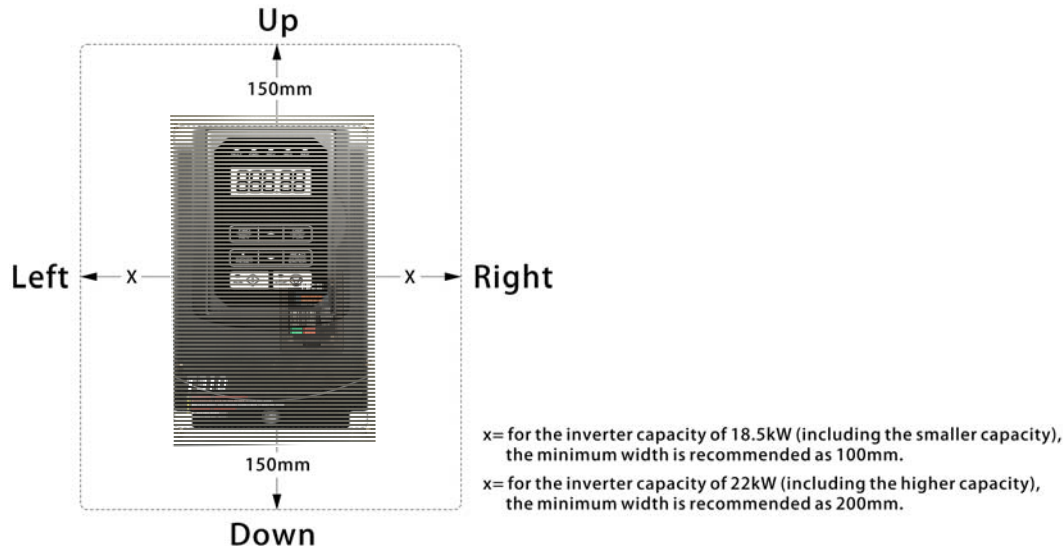

Fig 3.1 T310 Installation Space

(2) The temperature of inverter's radiator cooling fins may reach 90 °C in operation.

Therefore, the contact surface for the inverter installation shall be made by the high-temperature-resistant material.

When the inverter is operating in the power distribution box, the environment must be ventilated and the environmental temperature must be less than +40 ° C.

3.2.2 Outline dimension and caution

⚠ Caution

The environment will directly affect the proper operation and the life span of the inverter, so install T310 inverter complying with the following conditions:

- Ambient temperature: $-10^{\circ}\text{C} \sim +40^{\circ}\text{C}$ (IP20), $-10^{\circ}\text{C} \sim +50^{\circ}\text{C}$ (IP00), but maximally derate up to 60°C (can derate only above 40°C).
- Avoid rain, moisture and direct sunlight.
- Avoid corrosive liquid and gas, dust and small metal filings.
- Avoid some places with vibration and electromagnetic interference.
- If several inverters are placed in the same control panel, provide a heat removal fan to maintain ambient temperatures below 40°C

External view and part name of T310 inverter:

(a) 380V 15-20HP

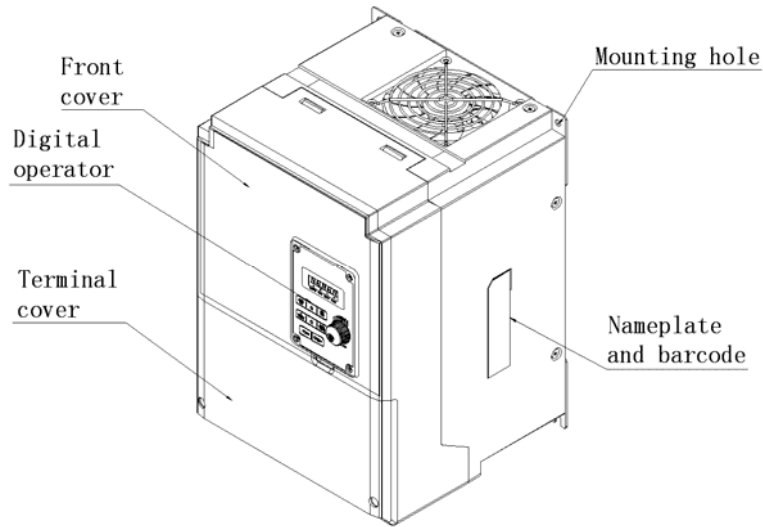

(Wall-mounted type, IEC IP20)

(b) 380V 25-30HP

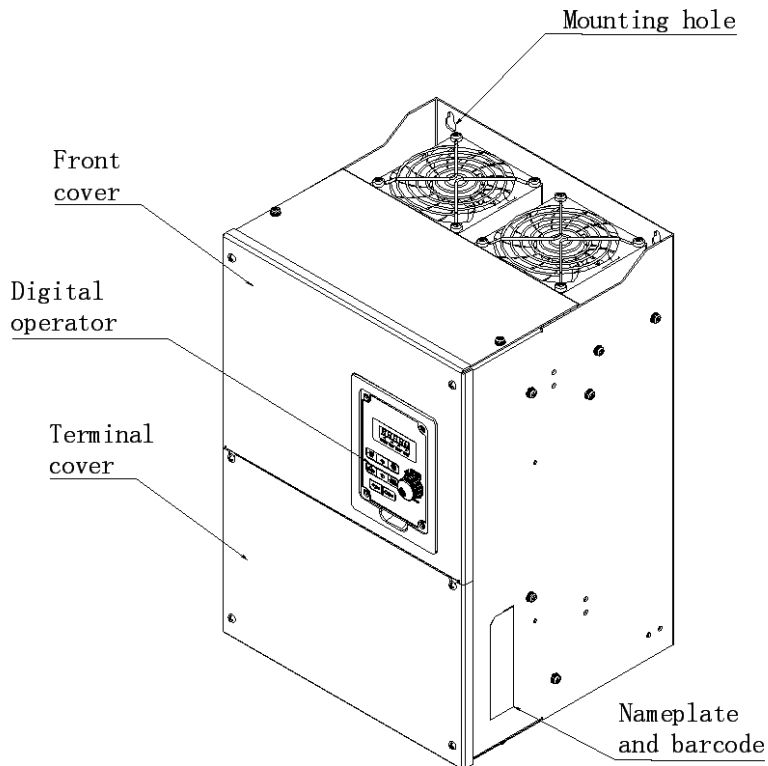

(Wall-mounted type, IEC IP20)

(c) 380V 40-50HP

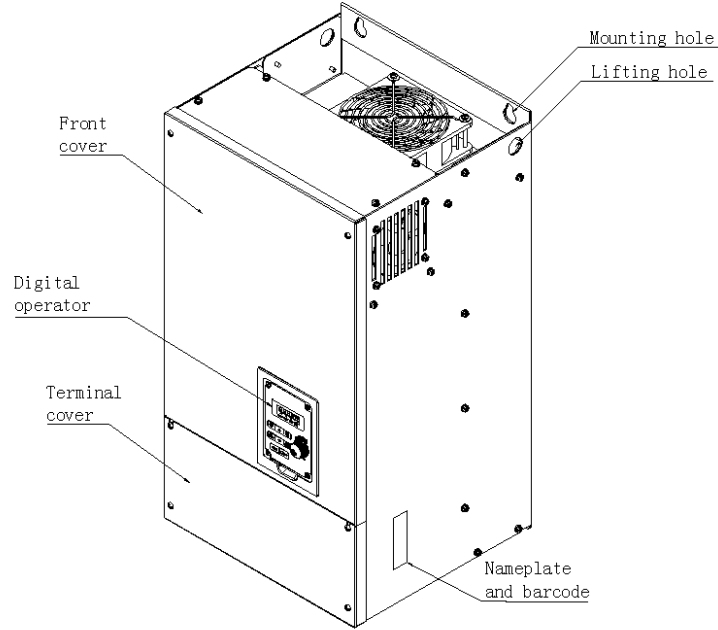

(Wall-mounted type, IEC IP20)

(d) 380V 60-75HP

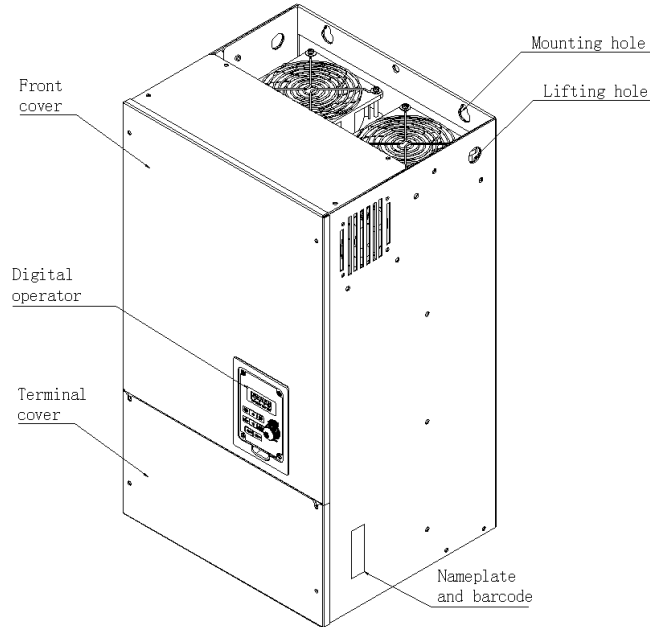

(Wall-mounted type, IEC IP20)

(e) 380V 100-125HP

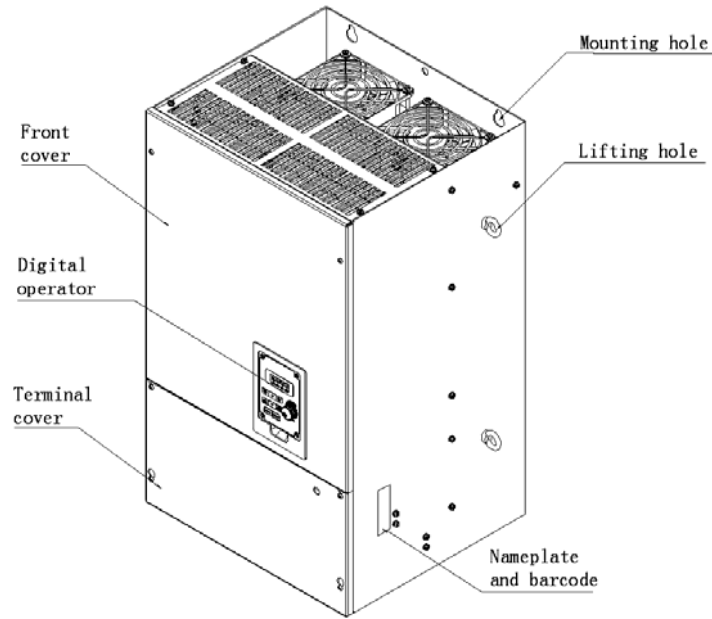

(Wall-mounted type, IEC IP00)

(f) 380V 150-215HP

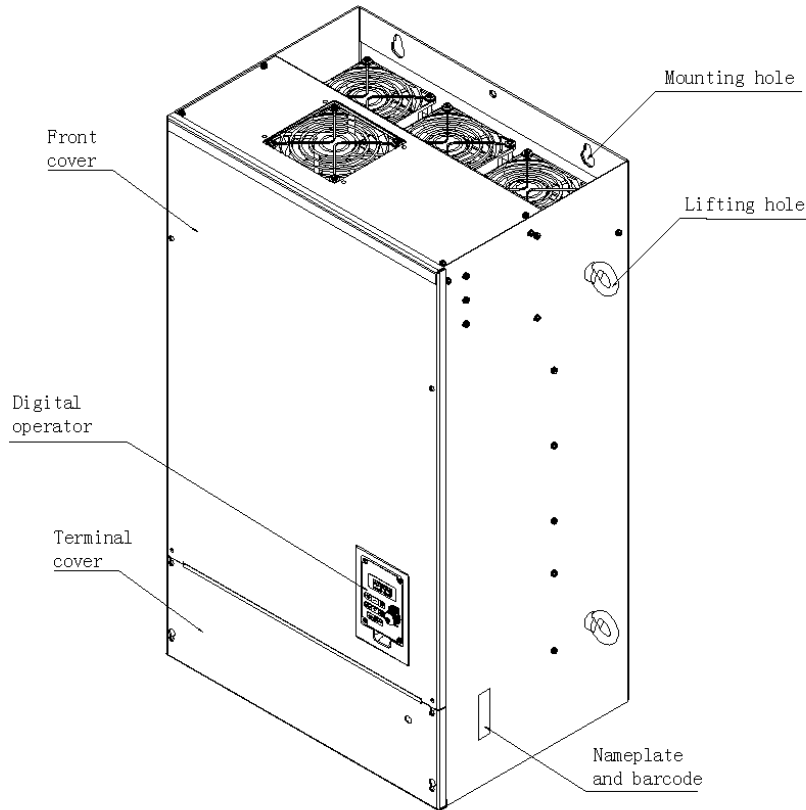

(Wall-mounted type, IEC IP00)

Fig 3.2 External view of T310

3-6

Must be sure to read the warning information on the front cover, see Figure 3.3

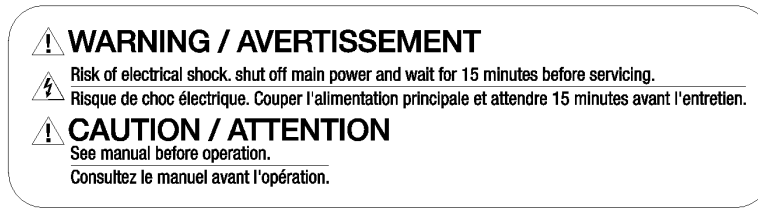



Fig 3.3 Warning information label

3.2.3 Product Dismounting

	Caution
<p>For T310 wiring, it is not necessary to disassemble the digital operator. First to loose screws of the external cover and take off the cover, then you can carry out the wiring work to the internal terminals of the inverter.</p> <ul style="list-style-type: none"> • Models of 380V 15-20HP are plastic shell. It is suggested to loose screws of the external cover and take off the cover. When wiring is completed, assemble the external cover of terminals and fasten screws. • Models of 380V 25-215HP are metal shell. It is suggested to loose screws of the external cover and take off the cover. When wiring is completed, assemble the external cover of terminals and fasten screws. 	

Disassembly/assembly steps for various models of T310, as shown in following:

a. 380V 15-20HP

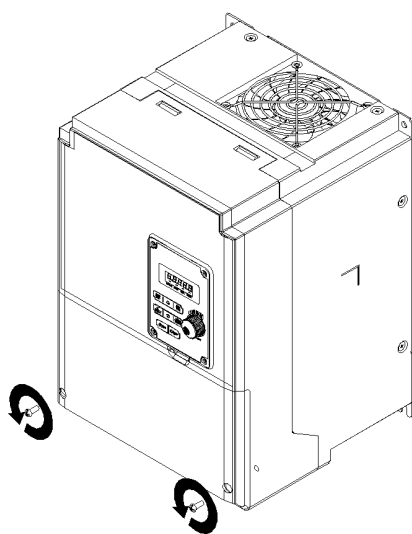

Step 1: Loose screws

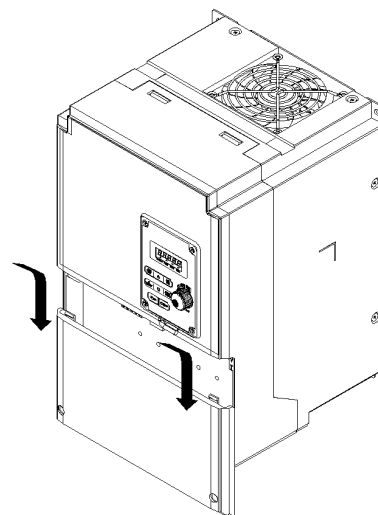

Step 2: Disassemble external cover

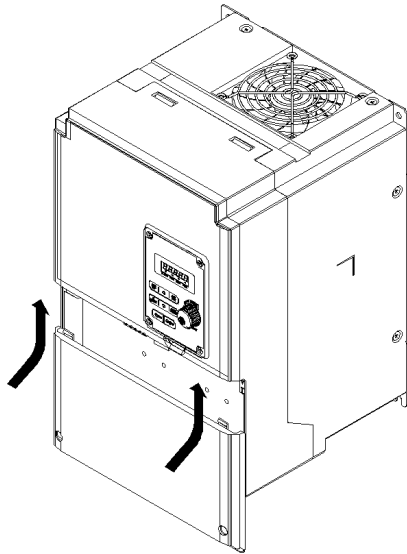

Step 3: Wiring and assemble the cover

c.380V 25-215HP

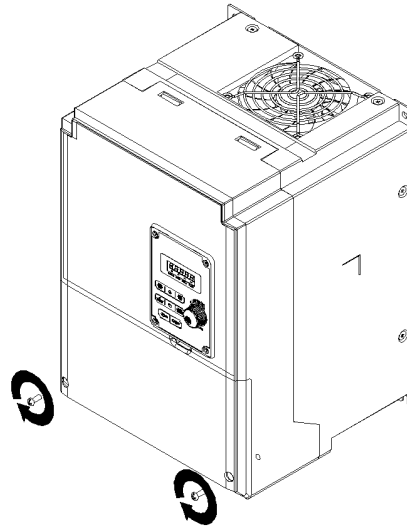

Step 4: Fasten screws

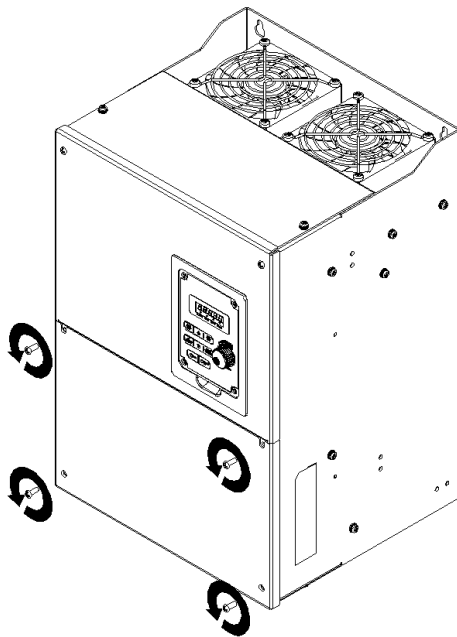

Step 1: Loose screws

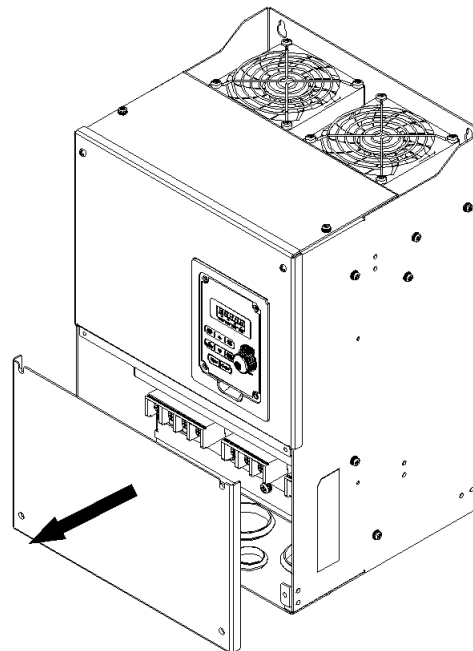

Step 2: Disassemble external cover

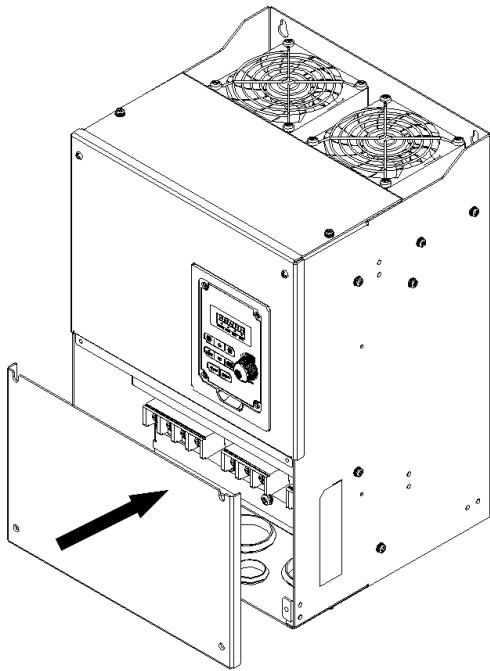

Step 3: Wiring and assemble the cover

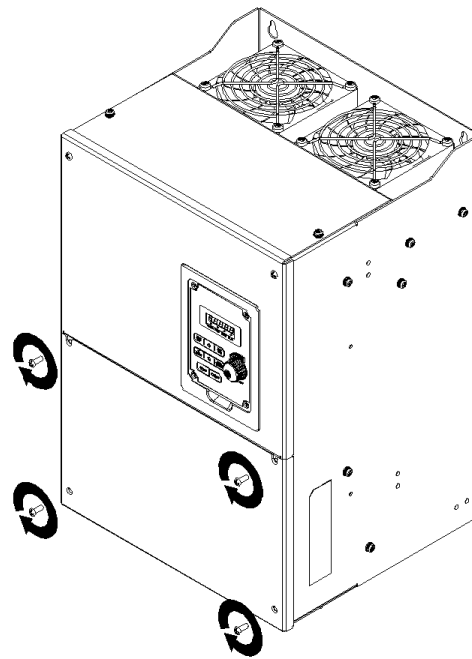

Step 4: Fasten screws

**To install DCL:
380V 15 ~30HP**

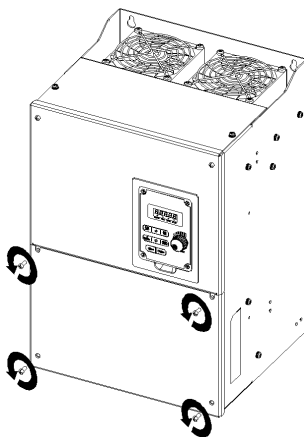

Step 1: Loose screws

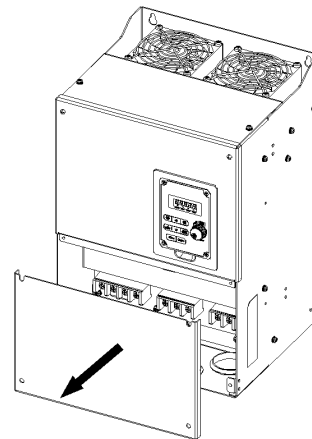

Step 2: Disassemble external cover

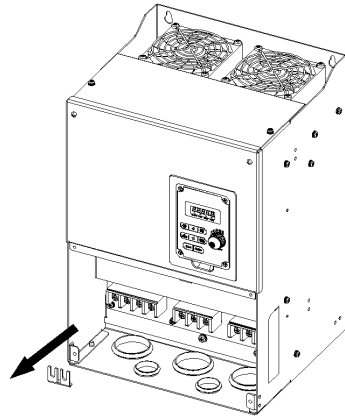

Step 3: Disassemble copper bar

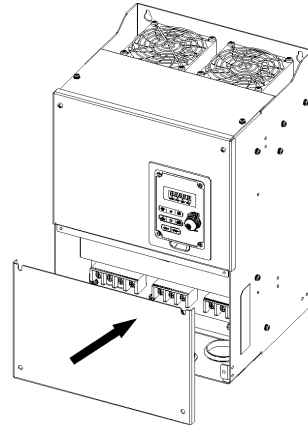

Step 4: To install DCL and assemble the cover

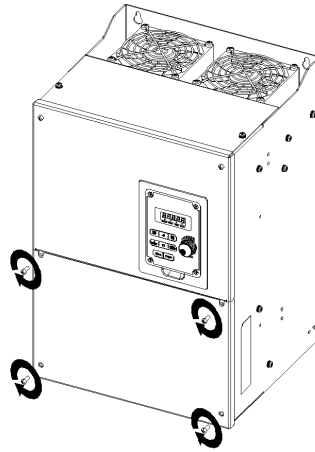

Step 5: Fasten screws

3.3 Wiring Peripheral Power Devices

 **Caution**

- After power is shut off to the inverter the capacitors will slowly discharge. Do NOT touch the inverter circuit or replace any components until the “CHARGE” indicator is off.
- Do NOT wire or connect/disconnect internal connectors of the inverter when the inverter is powered up or after power off but the “CHARGE” indicator is on.
- Do NOT connect inverter output U/T1、V/T2、W/T3 to the AC power source. This will result in damage to the inverter.
- The inverter must be properly grounded. Use terminal E to connect earth ground and comply with local standards.
- By respectively locking and removing chip-select grounding screw, the components on the inverter connect/disconnect to inverter metal shell (E) electricity. If the inverter is unearthed, or floating grid is limited to grounding current, please remove chip-select grounding screw.
- Do NOT perform a dielectric voltage withstand test (Megger) on the inverter this will result in inverter damage to the semiconductor components.
- Do NOT touch any of the components on the inverter control board to prevent damage to the inverter by static electricity.

380V: Fig. on removing 15HP~30HP chip-select grounding screw

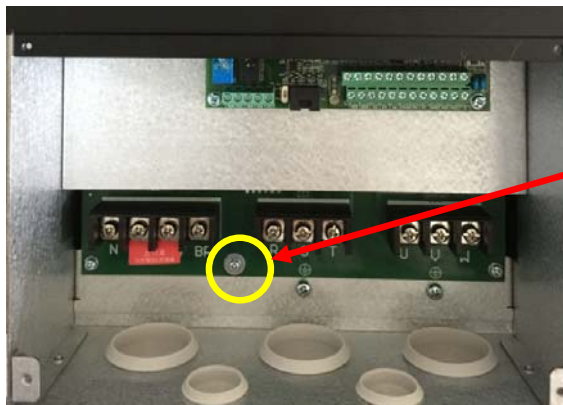

Remove chip-select grounding screw

380V: 40-215HP without chip-select grounding screw

 **Caution**

- Refer to the recommended wire size table 3 for the appropriate wire to use. The voltage between the power supply and the input terminals of the inverter may not exceed 2%.

Phase-to-phase voltage drop (V) = $\sqrt{3}$ × resistance of wire (Ω/km) × length of line m) × current × 10⁻³.

(km=3280 x feet) / (m=3.28 x feet)

- Reduce the carrier frequency (parameter 11-01) If the cable from the inverter to the motor is over 25m (82ft). A high-frequency current can be generated by stray capacitance between the cables and result in an overcurrent trip of the inverter, an increase in leakage current, or an inaccurate current readout.
- To protect interface equipment, install fast acting fuses on the input side of the inverter. Refer to section 6.4 for additional information.

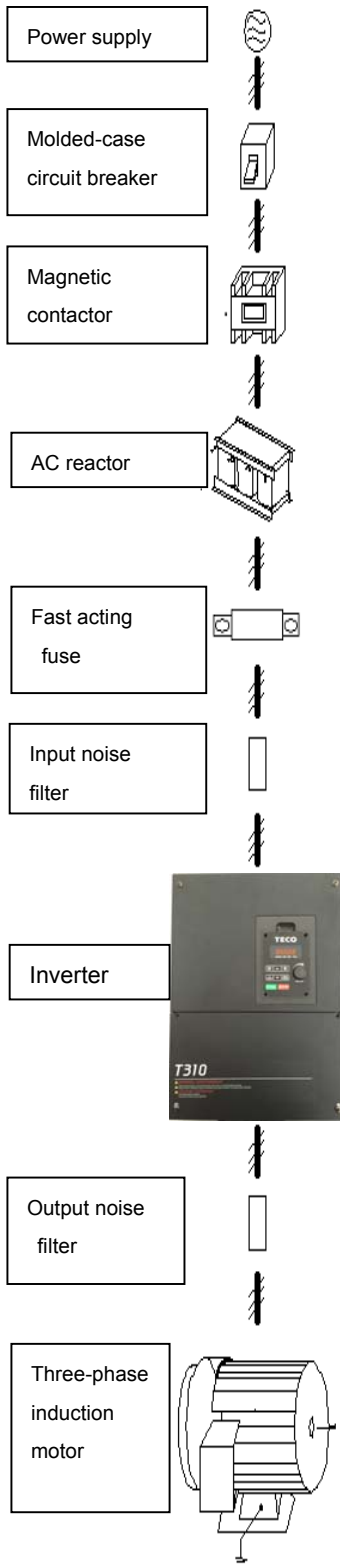

Power supply:

- Make sure the correct voltage is applied to avoid damaging the inverter.

Molded-case circuit breaker (MCCB) or fused disconnect:

- A molded-case circuit breaker or fused disconnect must be installed between the AC source and the inverter that conforms to the rated voltage and current of the inverter to control the power and protect the inverter.
- Do not use the circuit breaker as the run/stop switch for the inverter.

Ground fault detector / breaker:

- Install a ground fault breaker to prevent problems caused by current leakage and to protect personnel. Select current range up to 200mA, and action time up to 0.1 second to prevent high frequency failure.

Magnetic contactor:

- Normal operations do not need a magnetic contactor. When performing functions such as external control and auto restart after power failure, or when using a brake controller, install a magnetic contactor.
- Do not use the magnetic contactor as the run/stop switch for the inverter.

AC line reactor for power quality:

- When inverters are supplied by a high capacity power source (> 600KVA), an AC reactor can be connected to improve the power factor.

Install Fast Acting Fuse:

- To protect interface equipment, install fast acting fuses in accordance with the specifications in section 6. 4 for peripheral devices.

Input Noise filter:

- A filter must be installed when there are inductive loads affecting the inverter. The inverter meets EN55011 Class A, category C3 when the TECO special filter is used. See section 6. 3 for peripheral devices.

Inverter:

- Output terminals U/T1, V/ T2, and W/T3 are connected to U, V, and W terminals of the motor. If the motor runs in reverse while the inverter is set to run forward, swap any two terminals connections for U/T1, V/ T2, and W/T3.
- To avoid damaging the inverter, do not connect the output terminals U/T1, V/ T2, and W/T3 to AC input power.
- Connect the ground terminal properly. (380V class: $R_g < 10\Omega$.)

Output Noise filter:

- An output noise filter may reduce system interference and induced noise.

Motor:

- If the inverter drives multiple motors the output rated current of the inverter must be greater than the total current of all the motors.

General Wiring Diagram

The following is T310 converter standard wiring diagram (© said the main circuit terminal, ○ said the control loop terminal). According to the model, the location and symbols of the terminals are slightly different. Please refer to table 1 and 2 for the main circuit terminals and control circuit terminals.

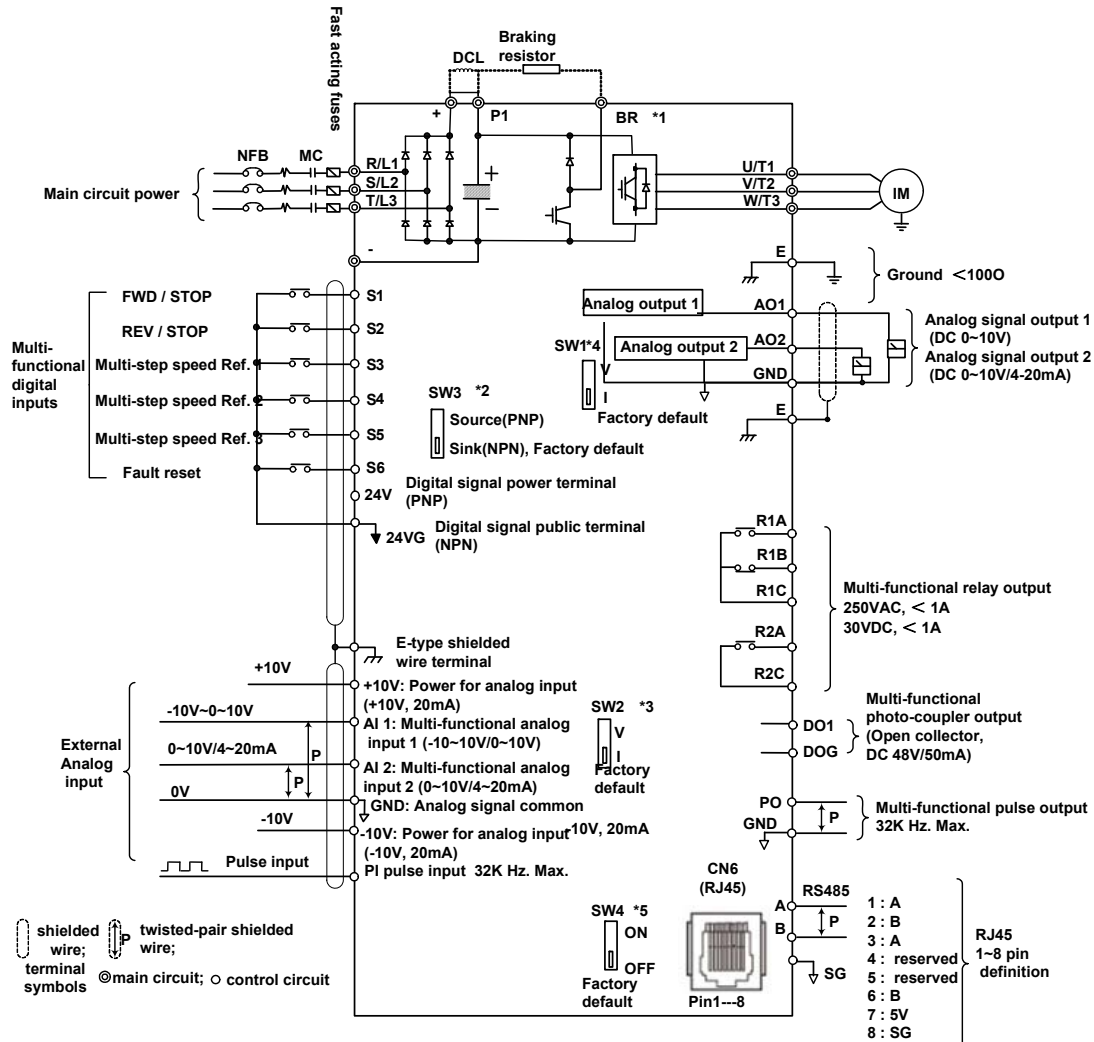

Notes:

- *1: 380V 15~30HP: included with built-in braking transistor. The braking resistor can be connected directly between P1 and BR. External DCL (among ϕ -P1) is reserved.
380V 40~215HP: included built-in DOL, without built-in braking transistor. The braking unit can be externally connected between ϕ - ϕ .
- *2: The multi-function digital input terminals S1~S6 can be set to Source (PNP, with +24V common) or Sink (NPN, with 24VG common) mode by SW3.
- *3: Multi-function analog input AI2 can be set to the voltage command input (0~10V) or the current command input (4~20mA) through SW2.
- *4: Multi-function analog output AO2 can be set to the voltage command output (0~10V) or the current command output (4~20mA) through SW1.
- *5: RS485: terminal resistance switch. The last inverter is needed starting when multiple inverters are used in parallel. The wiring method can refer to Annex A. The earth signal of RS485 is SG, isolated from analog signal - GND.

3.4 Power Terminals

Table 1 main circuit terminals

Terminal	380V: 15 ~ 30HP	380V: 40 ~ 215 HP
R/L1	Input Power Supply	
S/L2		
T/L3		
P1	<ul style="list-style-type: none"> • ⊕ - ⊖: DC power supply • P1 / BR: external braking resistor • ⊕-P1: External DCL*1 	<ul style="list-style-type: none"> • ⊕ - ⊖: DC power supply or connect braking module
BR		
⊖		
⊕		
U/T1	Inverter output	
V/T2		
W/T3		
E	Ground terminal	

Note:

*1: ⊕-P1: connected before ex-factory. Remove only when DCL is externally connected.

■ Descriptions of main circuit terminals

➤ 380V : 15 ~20HP



Terminal screw size	
T	
M4	M4

➤ 380V : 25 ~30HP



Terminal screw size	
T	
M5	M5

➤ 380V : 40-75HP

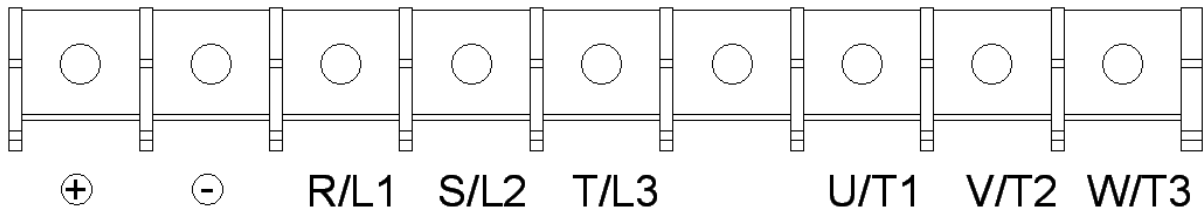

Terminal screw size	
T	
M8	M8

➤ 380V : 100HP

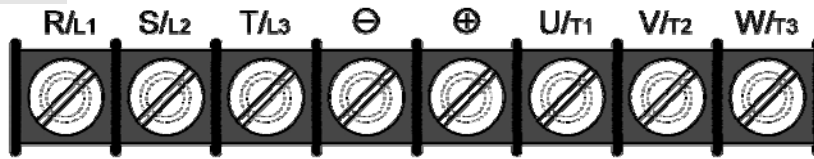

Terminal screw size	
T	
M10	M10

➤ 380V : 125~215HP

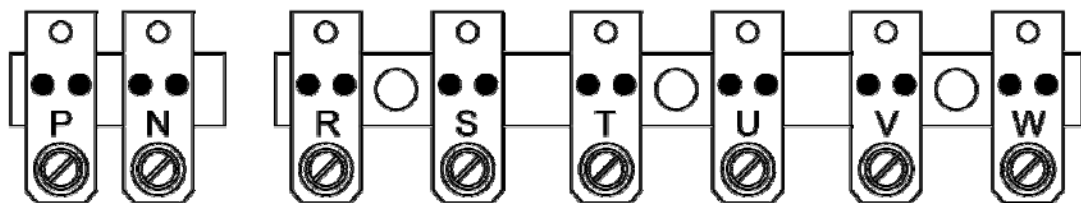

Terminal screw size	
T	
M10	M10

■ User Terminals (Control Circuit Terminals)

380V: 15~ 75HP



380V:100~300HP

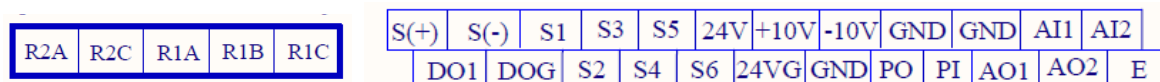

Table 2 Description of User Terminals

Type	Terminal	Terminal Function	Signal Level / Information
Digital input signal	S1	2-wire forward/ stop (default) * 1	Signal Level 24 VDC (photo isolated) Maximum current: 8mA Maximum voltage: 30 Vdc Input impedance: 4.22kΩ
	S2	2-wire reversal/ stop (default) * 1	
	S3	Multi-speed/ position setting command 1 (default) * 1	
	S4	Multi-speed/ position setting command 2 (default) * 1	
	S5	Multi-speed/ position setting command 3 (default) * 1	
	S6	Fault reset (default) * 1	
24V Power supply (separate winding)	24V	Digital signal SOURCE point (SW3 switched to SOURCE)	±15%, Max. output current: 250mA (The sum of all loads connected)
	24VG	Common terminal of Digital signals Common point of digital signal SINK (SW3 switched to SINK)	
Analog input signal	+10V	Power for external speed potentiometer	+10V (Max. current , 20mA)
	-10V	Power for external speed potentiometer	-10V (Max. current , 20mA)
	AI1	Multi-function analog input for speed reference (0-10V input)/(-10V~10V input)	From 0 to +10V, From -10V to +10V Input impedance : 20KΩ Resolution: 11bit + 1
	AI2	Multi-function analog input terminals *2, can use SW2 to switch voltage or current input (0~10V)/(4-20mA)	From 0 to +10V, Input impedance: 200KΩ From 4 to 20 mA Input impedance: 250KΩ Resolution: 11bit + 1
	GND	Analog signal ground terminal	----
	E	Shielding wire's connecting terminal (Ground)	----
Analog output signal	AO1	Multi-function analog output terminal (0~10V output)	From 0 to 10V, (Max. current , 2mA) From 4 to 20mA (Load < 500Ω) PWM Frequency: 10KHz
	AO2	Multi-function analog output terminals *3. can use SW1 to switch voltage or current input (0~10V / 4-20mA output)	
	GND	Analog signals ground terminal	
Pulse output signal	PO	Pulse output, Band width 32KHz.	Max. Frequency: 32KHz Open Collector output
	GND	Analog signals ground terminal	----
Pulse input signal	PI	Pulse command input, Bandwidth: 32KHz	L: from 0.0 to 0.5V H: from 4.0 to 13.2V Max. Frequency: 0 - 32KHz Built-in pull-up resistance.

Type	Terminal	Terminal Function	Signal Level / Information
			When open collector input is used, it is not required to connect resistance.
	GND	Analog signals ground terminal	----
Digital output	DO1	Multi-function(open collector transistor) output *1	48Vdc, 2mA ~50mA Open-collector output
	DOG	Open collector transistor digital ground	
Relay output	R1A	Relay A contact (multi-function output terminal)	Rating: 250Vac, 10 mA ~ 1A 30Vdc, 10 mA ~ 1A
	R1B		
	R1C	Relay B contact (multi-function output terminal) Relay contact common terminal, With the same functions as DO1	
	R2A-R2C	With the same functions as DO1	
RS-485 port	A	RS485/ Modbus communication protocol	Differential input and output
	B		
	SG	Zero Potential*4	Zero Potential

Notes:

*1:Multi-function digital input/ output can be referred to in this manual.

- Group 03: External Terminals Digital Input / Output Function Group.

*2:Multi-function analog input/ output can be referred to in this manual..

- Group 04 - External Terminal Analog Signal Input (Output) Function Group.

*3: The earth signal of RS485 – SG is isolated from analog signal public terminal – GND. Caution: not mixed.

Caution

- Maximum output current capacity for terminal 10V is 20mA.
- Multi-function analog output AO1 and AO2 are used for an analog output meter. Do not use these outputs for feedback control.
- Control board's 24V and $\pm 10V$ are to be used for internal control only, Do not use the internal power-supply to power external devices.

3.5 Input / Output Power Section Block Diagram

The following diagrams 1 - 2 show the basic configuration of the power sections for the range of horsepower and input voltages. This is shown for reference only and is not a detailed depiction.

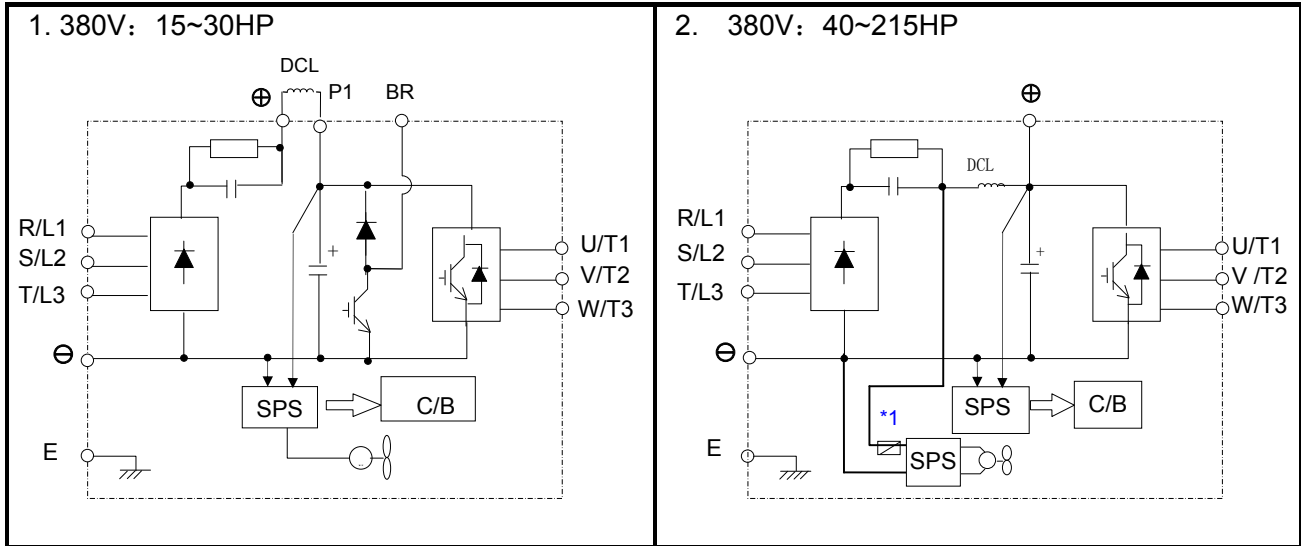

Note 1: 40/50HP without fan driving board; 60~215HP with fan driving board.

3.6 Power Input Wire Size, NFB and MCB Part Numbers

The following table shows the recommended wire size, molded case circuit breakers and magnetic contactors for each of the T310 models. It depends on the application whether or not to install a circuit breaker. The NFB must be installed between the main input power supply and the inverter input (R/L1, S/L2, T/L3).

Note: When using a ground protection make sure the current setting is above 200mA and trip delay time is 0.1 sec of higher.

Table 3 Wiring instrument for 380V class

Power	T310 Model			wire diameter (mm ²)			NFB ^{*4}	MC ^{*4}
	horse power (HP) ^{*1}	Rated KVA HD	Rated current (A) HD	Main circuit ^{*2}	Grounding line E(G)	Control line ^{*3}		
380V 3 ∅	15HP	18.3	24	8	8	0.5~2	TO-100S(50A)	CU-25
	20HP	23.6	31	8	8	0.5~2	TO-100S(50A)	CU-35
	25HP	29.7	39	8	8	0.5~2	TO-100S(50A)	CU-50
	30HP	34.3	45	14	8	0.5~2	TO-100S(75A)	CU-50
	40HP	45.7	60	22	8	0.5~2	TO-100S(100A)	CU-65
	50HP	57.2	75	22	14	0.5~2	TO-100S(100A)	CU-80
	60HP	69.3	91	38	14	0.5~2	TO-225S(150A)	CN-100
	75HP	89.9	118	60	22	0.5~2	TO-225S(175A)	CN-125
	100HP	114	150	80	22	0.5~2	TO-225S(225A)	CN-150
	125HP	137	180	150	22	0.5~2	TO-400S(300A)	CN-300
	150HP	165	216	150	22	0.5~2	TO-400S(300A)	CN-300
	175HP	198	260	200	30	0.5~2	TO-400S(400A)	CN-300
215HP	225	304	250	30	0.5~2	TO-400S(400A)	CN-300	

*1: Constant torque rating.

*2: The main circuit terminals: R/L1, S/L2, T/L3, U/T1, V/T2, W/T3, P1, BR, ⊖, ⊕

*3: Control line is the terminal wire on the control board.

*4: The NFB and MCB listed in the table are of TECO product numbers, products with same rated specification of other brands may be used. To reduce electrical noise interference, ensure that a RC surge absorber (R: 10Ω/5W, C: 0.1μf/1000VDC) is added to both sides of MCB coil.

Pay attention to the following points on the external wiring:

(A) Control Circuit Wiring

- (1) Separate the wiring for control circuit terminals from main circuit wiring for terminals (R/L1, S/L2, T/L3, U/T1, V/T2, W/T3).
- (2) Separate the wiring for control circuit terminals R1A-R1B-R1C (or R2A, R2C) (Relay outputs) from wiring for terminals S1~6, A01, A02, GND, DO1, DOG, +10V, -10V, A11 AND A12 wiring.
- (3) Use shielded twisted-pair cables (#24 - #14 AWG / 0.5 - 2 mm²) shown in Fig. 3.4 for control circuits to minimize noise problems. The maximum wiring distance should not exceed 50m (165 ft).

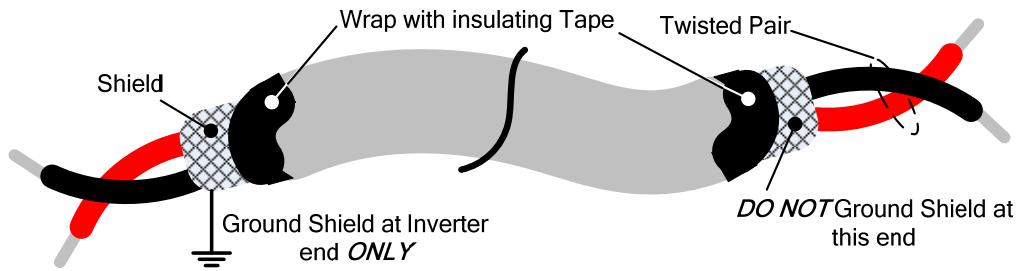

Fig. 3.4 Shielded Twisted-Pair

(4) When the digital multi-function output terminals (DO1) are connected to an external relay, a freewheeling diode should be connected across the relay coil to prevent an inductive voltage spike from damaging the output circuitry as shown in Fig. 3.5 below.

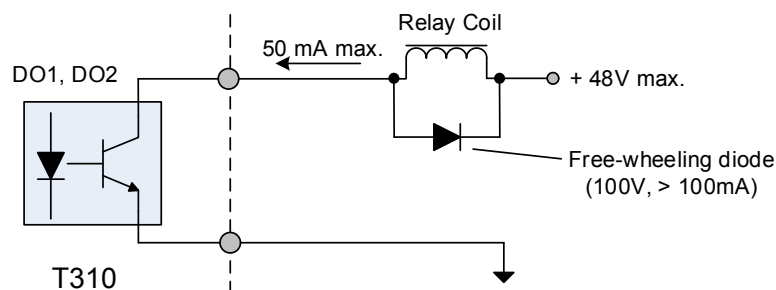

Fig. 3.5 Photo-Coupler Connected to an External Relay

(B) Power input terminals

1. The Input power supply voltage can be connected in any phase sequence to power input terminals R/L1, S/L2, or T/L3 on the terminal block.
2. DO NOT connect the AC input power source to the output terminals U/T1, V/T2 and. W/T3.
3. Connect the output terminals U/T1, V/T2, W/T3 to motor lead wires U/T1, V/T2, and W/T3, respectively.
4. Check that the motor rotates forward with the forward run source. If it does not, swap any 2 of the output cables to change motor direction.
5. DO NOT connect phase correcting capacitors or LC/RC noise filter to the output circuit.

(C) Grounding

1. Connect the ground terminal (E) to ground having a resistance of less than 100Ω .
2. Do not share the ground wire with other devices, such as welding machines or power tools.
3. Always use a ground wire that complies with the local codes and standards for electrical equipment and minimize the length of ground wire.
4. When using more than one inverter, be careful not to loop the ground wire, as shown below in Fig. 3.6

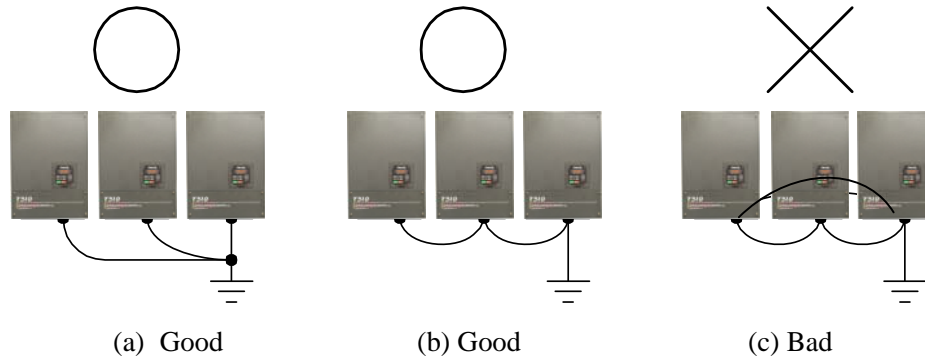

Fig. 3.6 Inverter Grounding

■ Input Power and Motor Cable Length

The length of the cables between the input power source and /or the motor and inverter can cause a significant phase to phase voltage reduction due to the voltage drop across the cables. The wire size is based on a maximum voltage drop of 2%. If this value is exceeded, a wire size having larger diameter may be needed. To calculate phase to phase voltage drop, apply the following formula:

$$\text{Phase-to-phase voltage drop (V)} = \sqrt{3} \times \text{resistance of wire } (\Omega/\text{km}) \times \text{length of line (m)} \times \text{current (A)} \times 10^{-3}.$$

$$(\text{km}=3280 \times \text{feet})$$

$$(\text{m}=3.28 \times \text{feet})$$

■ Installing an AC Line Reactor

If the inverter is connected to a large-capacity power source (600kVA or more), install an optional AC reactor on the input side of the inverter. This also improves the power factor on the power supply side.

■ Cable Length vs. Carrier Frequency

The allowable setting of the PWM carrier frequency is also determined by motor cable length and is specified in the following Table 4.

Table 4 Cable Length vs. Carrier Frequency

Cable length between the inverter and Motor in m (ft.).	< 30m (100)	30 – 50m (100 – 165)	50 – 100m (166 - 328)	≥ 100m (329)
Recommended carrier frequency allowed Parameter 11-01	16kHz (max)	10 kHz (max)	5 kHz (max)	2 kHz (max)

3.7 Inverter Specifications

Basic Specifications 400V class

Inverter capacity (HP)		15	20	25	30	40	50	60	75	100	125	150	175	215	
Output rated	Rated output Capacity (KVA)	18.3	23.6	29.7	34.3	45.7	57.2	69.3	89.9	114	137	165	198	225	
	Rated output current (A)	24	31	39	45	60	75	91	118	150	180	216	260	304	
	Maximum applicable motor ^{**1} HP (KW)	15 (11)	20 (15)	25 (18.5)	30 (22)	40 (30)	50 (37)	60 (45)	75 (55)	100 (75)	125 (90)	150 (110)	175 (132)	215 (160)	
	Motor rated current (A) ^{**1}	18.6	24.8	31.1	36.3	48.7	59	70.5	88	114	145	175	205	248	
	The maximum output voltage (V)	3-phase 380V~440V													
	The maximum output frequency (Hz)	Based on parameter setting 0.1~599.0 Hz													
Power	Rated voltage, frequency	3-phase 380V ~ 440V, 50/60Hz													
	Allowable voltage fluctuation	-15% ~ +10%													
	Allowable frequency fluctuation	±5%													

*1: Take TECO standard 4-pole induction motor as the base.

*2: It is the specification for TECO standard inverter.

*3: The overload capacity of T310 is 150% / 1min. See the table below for the carrier frequency default setting and range.

*4: If it is greater than default carrier frequency, you need to adjust the load current based on the de-rating curve.

Inverter Voltage and Capacity	carrier frequency range	carrier frequency factory setting
380V class		
15~30HP	1~16kHz	8kHz
40~50HP	1~12kHz	5kHz
60~175HP	1~10kHz	5kHz
125HP	2~8kHz	4kHz
215HP	2~8kHz	3kHz

The following table shows maximum output frequency for each control mode.

Duty Cycle	Control mode	Other settings	Maximum output frequency
Heavy Duty (00-27=0)	V/F SLV2	maximum frequency set to 599Hz	599Hz
	SLV	380V 15HP	150Hz
		380V 20HP	110Hz
		380V 25~30HP	100Hz
		380V 40~215HP, carrier (11-01) is set as 8K or below 8K	100Hz
	380V 40~175HP, carrier (11-01) is above 8K	80Hz	

*5: If control mode (00-00) is set to 2 (SLV mode) and maximum frequency (01-02) is larger than 80Hz, the carrier frequency range is 4~8 KHz.

• General Specifications

Control characteristics	Operation mode	LCD keypad with parameter copy function (Optional Seven-segment display * 5 + LED keypad)
	Control mode	V/F, SLV, SLV2 with space vector PWM mode
	Frequency control range	0.1Hz~599.0Hz
	Output frequency accuracy (Temperature change)	Digital references: $\pm 0.01\%$ (-10 to +40°C) Analog references: $\pm 0.1\%$ (25°C $\pm 10^\circ\text{C}$)
	Speed control accuracy	$\pm 0.5\%$ (vector control / open-loop)
	Frequency setting resolution	Digital references: 0.01Hz, Analog references: 0.03Hz/60Hz (If the maximum output frequency of motor is over 300HZ,the frequency resolution is changed to 0.1Hz)
	Output frequency resolution	0.01Hz (If the maximum output frequency of motor is over 300HZ,the frequency resolution is changed to 0.1Hz)
	Inverter overload	Rated output current 150%/1 min
	Frequency setting signal	0 to +10VDC / 4 to 20mA or -10V to +10VDC and pulse input command frequency
	Acceleration / deceleration time	0.1- 6000.0 second (separately set acceleration and deceleration time)
	Voltage, frequency characteristics	Custom V/f curve based on parameters
	Braking torque	+/- 20%
	Main control functions	Auto-tuning , Soft-PWM, over-voltage protection, dynamic braking, speed search, frequency traversing, instantaneous power fault restart, PID control, automatic torque compensation, automatic speed regulation, RS-485 communication standard, 2 sets of analog outputs, safety switch.
	Other functions	Accumulated power-on / run time, 4 sets of fault history records and latest fault record state, energy-saving function setting, single phase protection, smart braking, DC braking, Dwell, S curve acceleration and deceleration, Up / Down operation, MODBUS protocol, pulse output, engineering units, SINK / SOURCE digital inputs.
	Protection functions	Stall protection
Instantaneous over current (OC) and output short-circuit (SC) protection		Inverter stops when the output current exceeds 200% of the inverter rated current.
Inverter overload Protection (OL2)		Inverter rated current 150%/1 min., factory default carrier frequency setting is 8~2kHz.
Motor overload (OL1) protection		Electrical overload protection curve I ² T
Over voltage(OV) protection		If the main circuit DC voltage rises over 820V (380V class),the motor stops running.
Under voltage (UV)		If the main circuit DC voltage falls below 380V (380V class), the motor stops running.
Automatic restart after instantaneous power fault		Power fault exceeds 15ms. Automatic restart function available after instantaneous power fault in 2sec.
Overheat protection(OH)		Uses temperature sensor for protection.
Ground Fault protection(GF)		Use current sensor for protection.
DC bus charge indicator		When main circuit DC voltage $\geq 50\text{V}$, the CHARGE LED turns on.
Output Phase Loss Protection (OPL)	If the OPL is detected the motor stops automatically.	

Environment Specification	Location	Indoor (protected from corrosive gases and dust).
	Ambient temperature	-10~+40°C (14°F~104°F) (IP20), -10~+50°C (14°F~122°F) (IP00)) without de-rating; with de-rating, its maximum operation temperature is 60°C (140°F)
	Storage temperature	-20~+70°C (-4°F~+158°F)
	Humidity	95%RH or less (no condensation)
	Altitude and vibration	Altitude of 1000m (3181ft) or below ; 1.0G, IEC60068-2-6
Communication function	RS-485 standard (MODBUS RTU / ASCII protocol)	
EMI protection	The built-in noise filter complies with EN61800-3 available for inverters .	
EMS protection	EN61800-3	

■ Inverter Derating Based on Carrier Frequency

380V Models

output current (I_{OUT})

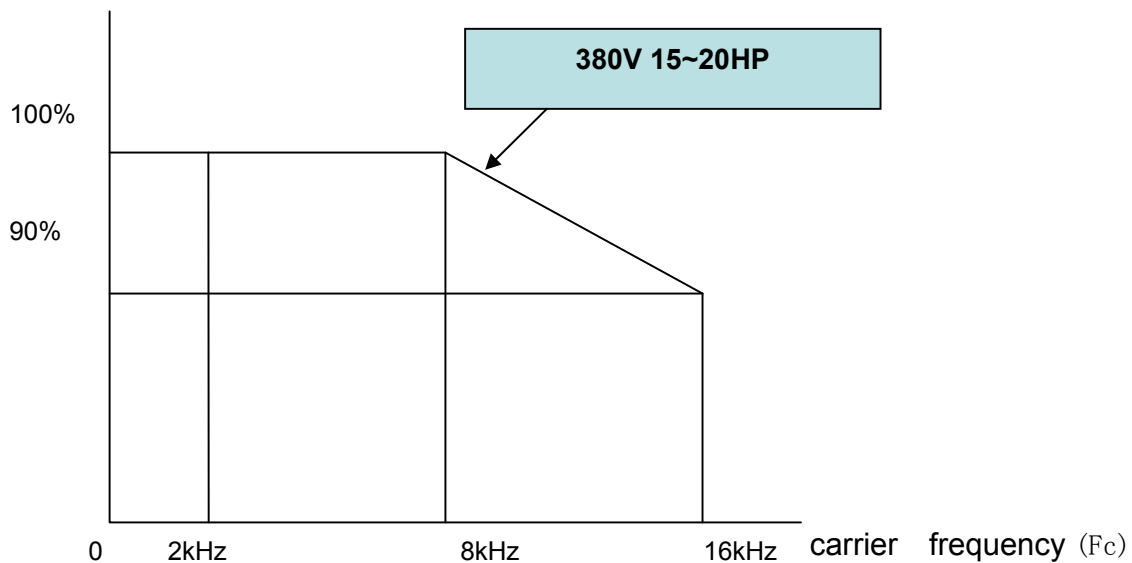

3-25

output current (I_{OUT})

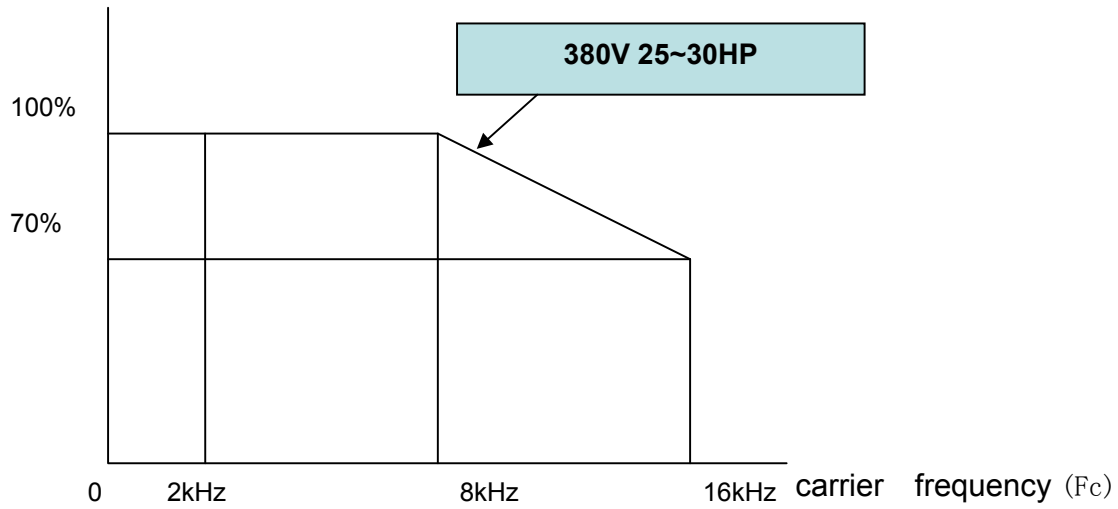

output current (I_{OUT})

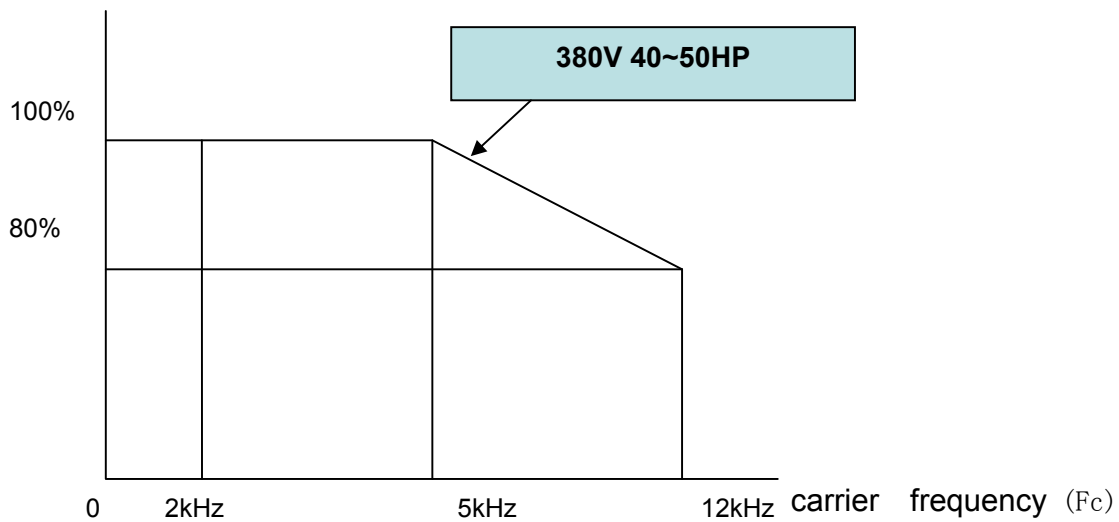

output current (I_{OUT})

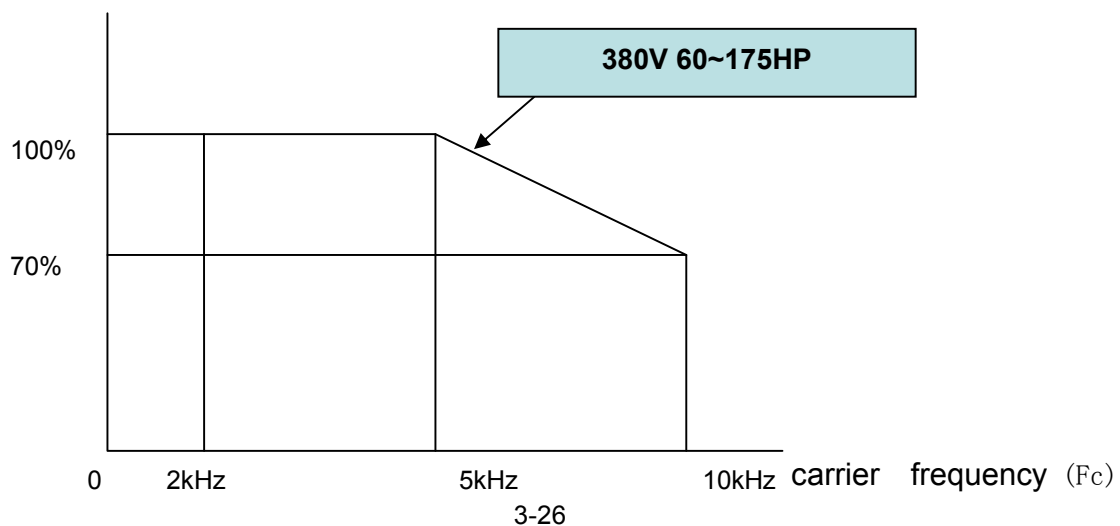

3-26

output current (I_{OUT})

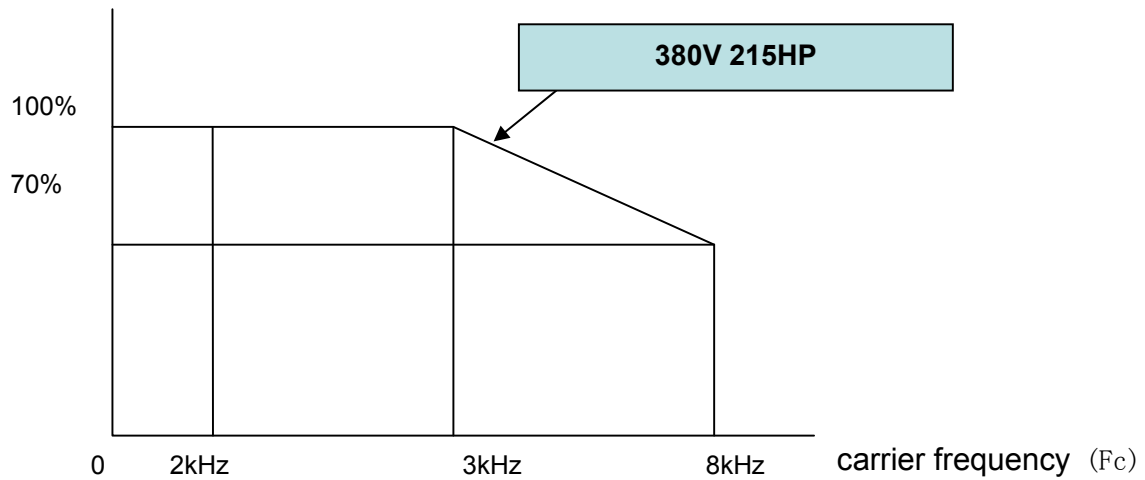

■ Inverter Derating Based on Temperature

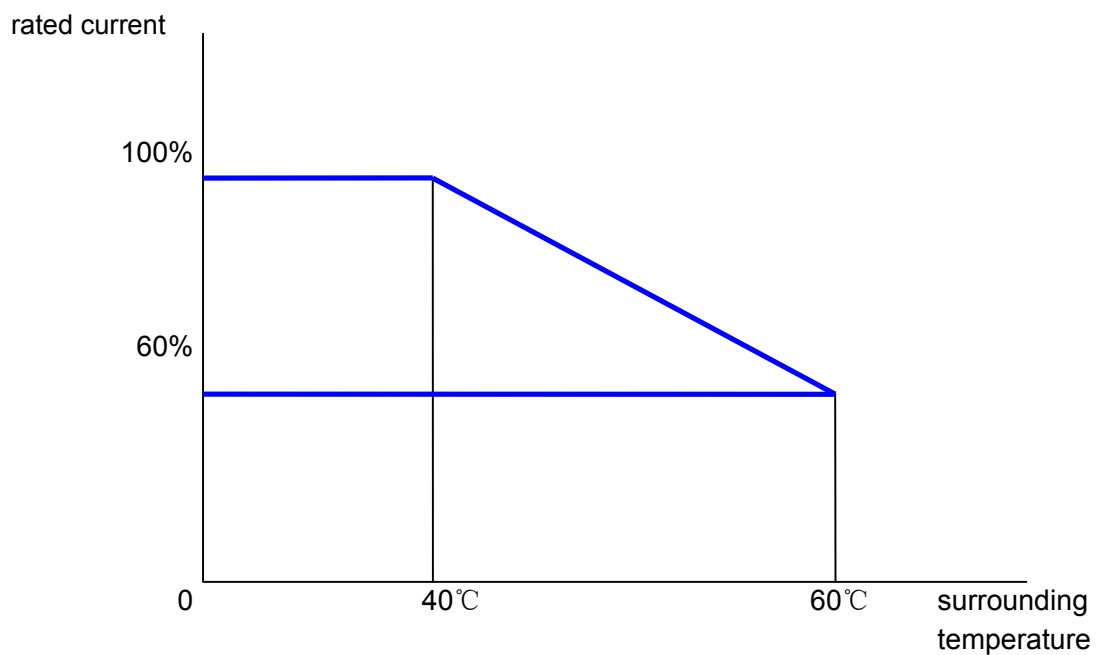

*** Users should select inverter capacity according to environmental temperature, to avoid improper selection.**

◆ Capacitor reforming Guide after long storage

For correct performance of this product after long storage before use it is important that Inverter Capacitors are reformed according to the guide below:

Storage time	Procedure to re-apply voltage
≅ 1 year	Apply rated voltage(*1) of inverter in the normal way
Between 1-2 years	Apply rated voltage of inverter to the product for one hour
≅ 2 years	Use a variable AC power supply to 1. Connecting 25% of inverter rated voltage for 30 minutes. 2. Connecting 50% of inverter rated voltage for 30 minutes. 3. Connecting 75% of inverter rated voltage for 30 minutes. 4. Connecting 100% of inverter rated voltage for 210 minutes. Once the procedures completed, inverter just can be used normally.

*1 : Rated voltage: please connects rated voltage according to model label of inverter.

3.8 Overall Dimension drawing

Standard Model

(a) 380V :15-20HP (IP20)

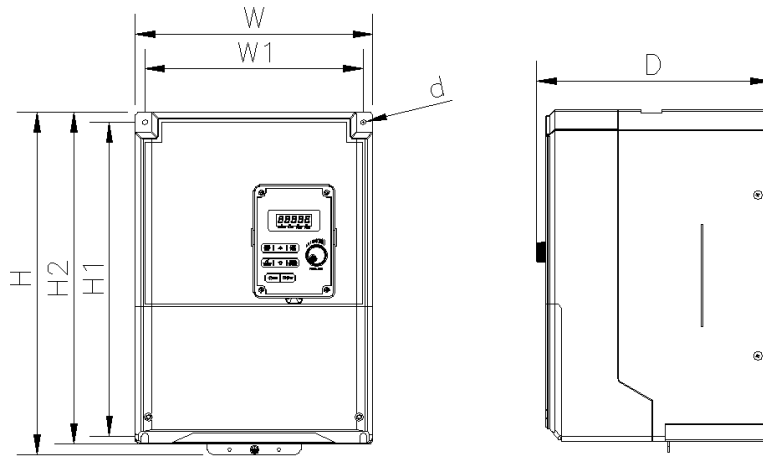

Inverter Model	Dimension (mm)							GW(kg)	Notes
	W	H	D	W1	H1	H2	d		
T310-4015-H3C	215	315	212	198	284	300	M5	6.2	
T310-4020-H3C	215	315	212	198	284	300	M5	6.2	

(b) 380V :25-30HP (IP20)

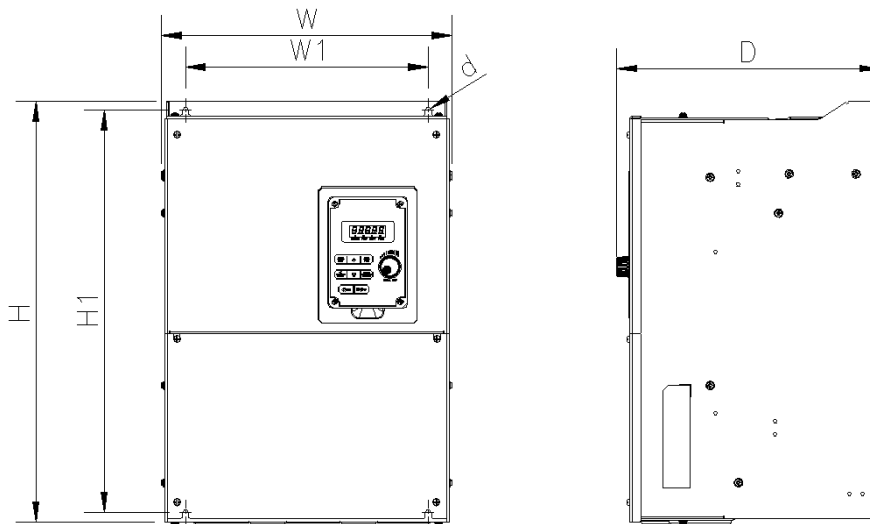

Inverter Model	Dimension (mm)							GW(kg)	Notes
	W	H	D	W1	H1	d			
T310-4025-H3C	256	378	234	218	360	M6	15		
T310-4030-H3C	256	378	234	218	360	M6	15		

(c) 380V :40-75HP (IP20)

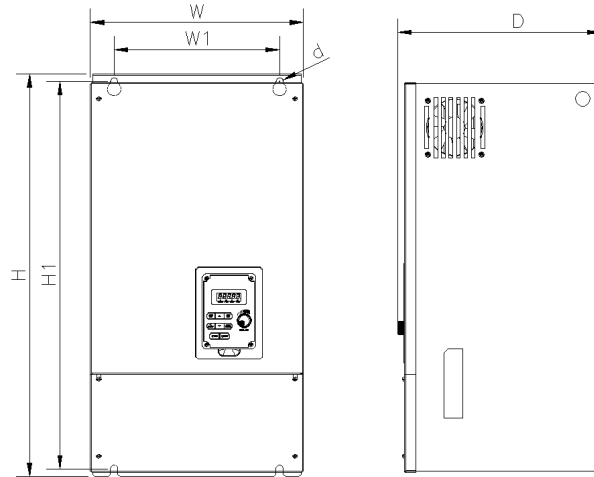

Inverter Model	Dimension (mm)							Notes
	W	H	D	W1	H1	d	GW(kg)	
T310-4040-H3C	284	535	270	220	515	M8	30	
T310-4050-H3C	284	535	270	220	515	M8	30	
T310-4060-H3C	323	575	292	220	553	M8	40	
T310-4075-H3C	323	575	292	220	553	M8	40	

(d) 380V :100-215HP (IP00)

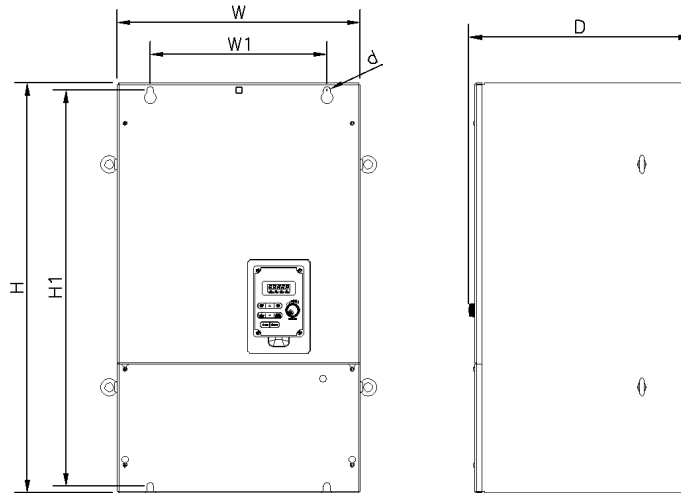

Inverter Model	Dimension (mm)							Notes
	W	H	D	W1	H1	d	GW(kg)	
T310-4100-H3C	344	580	315	250	560	M8	42	
T310-4125-H3C	344	580	315	250	560	M8	42	
T310-4150-H3C	459	790	333	320	760	M10	81	
T310-4175-H3C	459	790	333	320	760	M10	81	
T310-4215-H3C	459	790	333	320	760	M10	81	

(e) 380V :100-125HP (IP20)

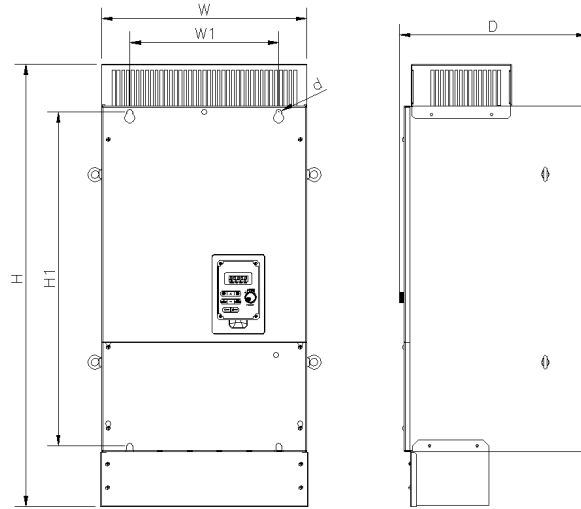

Inverter Model	Dimension (mm)							Notes
	W	H	D	W1	H1	d	GW(kg)	
T310-4100-H3C	344	742	315	250	560	M8	46	Need the replacement parts JN3-NK-A07
T310-4125-H3C	344	742	315	250	560	M8	46	

(f) 380V :150-215HP (IP20)

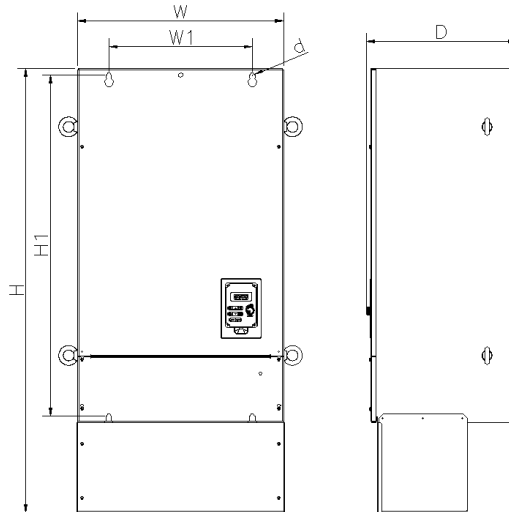

Inverter Model	Dimension (mm)							Notes
	W	H	D	W1	H1	d	GW(kg)	
T310-4150-H3C	459	990	333	320	760	M10	85	Need the replacement parts JN3-NK-A08
T310-4175-H3C	459	990	333	320	760	M10	85	
T310-4215-H3C	459	990	333	320	760	M10	85	

Chapter 4 Keypad and Programming Functions

4.1 LED Keypad

4.1.1 Keypad Display and Keys



DISPLAY	Description
5 Digit LED Display	Monitor inverter signals, view / edit parameters, fault / alarm display.
LED INDICATORS	Description
Hz/RPM	Frequency signal indicator
FWD	LED ON when inverter is running in forward direction, flashing when stopping.
REV	On when inverter is running in reverse direction, flashing when stopping.
FUN	Indicator on when parameter menu is displayed on the surface.
KEYS (8)	Description
RUN	RUN Inverter in Local Mode
STOP	STOP Inverter
▲	Parameter navigation Up, Increase parameter or reference value
▼	Parameter navigation down, decrease parameter or reference value
FWD/REV	Used to switch between Forward and Reverse direction
DSP/FUN	Used to scroll to next screen Frequency screen → Function selection → Monitor parameter
◀ / RESET	Selects active seven segment digit for editing with the ▲ ▼ keys Used to reset fault condition.
READ / ENTER	Used to read and save the value of the active parameter

Auto-Repeat Keys:

Holding the ▲ UP or ▼ DOWN key for a longer period of time will initiate the auto-repeat function resulting in the value of the selected digit to automatically increase or decrease.

4.1.2 Seven Segment Display Description











Actual	LED Display	Actual	LED Display	Actual	LED Display	Actual	LED Display
0		A		L		Y	
1		B		n		-	
2		C		o		°	
3		D		P		-	
4		E		q		.	
5		F		r			
6		G		S			
7		H		t			
8		I		u			
9		J		v			

Display output frequency LED lights on	Frequency Reference LED flashes	Set Frequency Reference Flashing digit

- ◆ At power-up, the display will show the frequency reference setting and all LEDs are flashing. Press the ▲ (UP) or ▼ (DOWN) key to enter the frequency reference edit mode, use the ◀/RESET key to select which digit to edit (flashing). Use the ▲ (UP) or ▼ (DOWN) key to modify the value and press the READ / ENTER key to save the frequency reference and switch back to the frequency reference display mode.
- ◆ During run operation, the display will show the output frequency.



Note: When in edit mode and the READ / ENTER is not pressed within 5 sec, the inverter will switch back to the frequency reference display mode.

LED Display Examples



Seven Segment Display	Description
	<ol style="list-style-type: none"> 1. Displays the frequency reference at power-up. 2. Displays the actual output frequency during run operation.
	Displays parameter code.
	Displays the setting value of parameter.
	Displays input voltage.
	Displays inverter current.
	Displays DC Bus Voltage.
	Displays temperature.
	Displays PID feedback value; The displayed digit is set by 12-01.
	Error display; refer to chapter 5 Troubleshooting and Maintenance.
	Displays AI1/ AI2 input (0~100%)

4.1.3 LED Indicator Description

- **Forward LED**

State	Description	FWD LED
Off	Inverter in reverse direction	
Illuminated	Inverter is running in forward direction	
Flashing	Forward direction active, no run command	

- **Reverse LED**

State	Description	REV LED
Off	Inverter in forward direction	
Illuminated	Inverter is running in reverse direction	
Flashing	Reverse direction active, no run command	

- **Hz/RPM LED**

State	Description	Hz/RPM LED
Illuminated	Indicator on when frequency or line speed is displayed.	

- **FUN LED**

State	Description	FUN LED
Illuminated	Indicator on when non-frequency or non line speed is displayed.	

4.1.4 Power-up Monitor

◆ Power-up

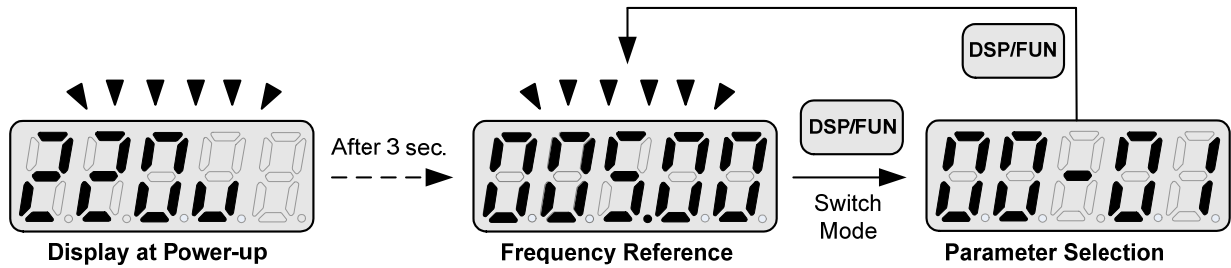

◆ Changing Monitor at Power-up

12- 00	Display Selection
Range	Highest bit -> 0 0 0 0 0 <- Lowest bit The setting range for each bit is 0 ~ 7 from the highest bit to the lowest bit.
	0: No display 4: Temperature
	1: Output current 5: PID feedback
	2: Output voltage 6: AI1 value
	3: DC voltage 7: AI2 value

Example: 12- 00= 【10000】

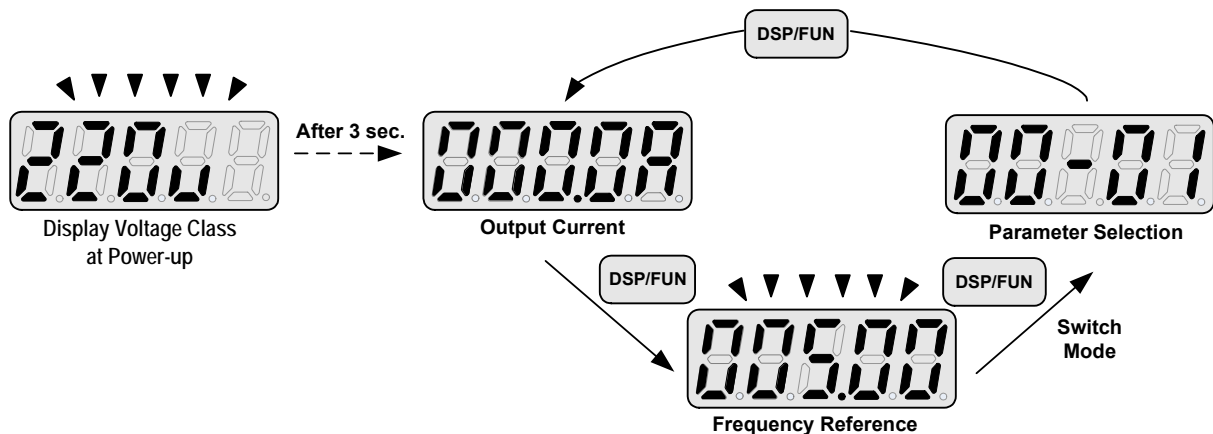

Example: 12-00= 【12345】

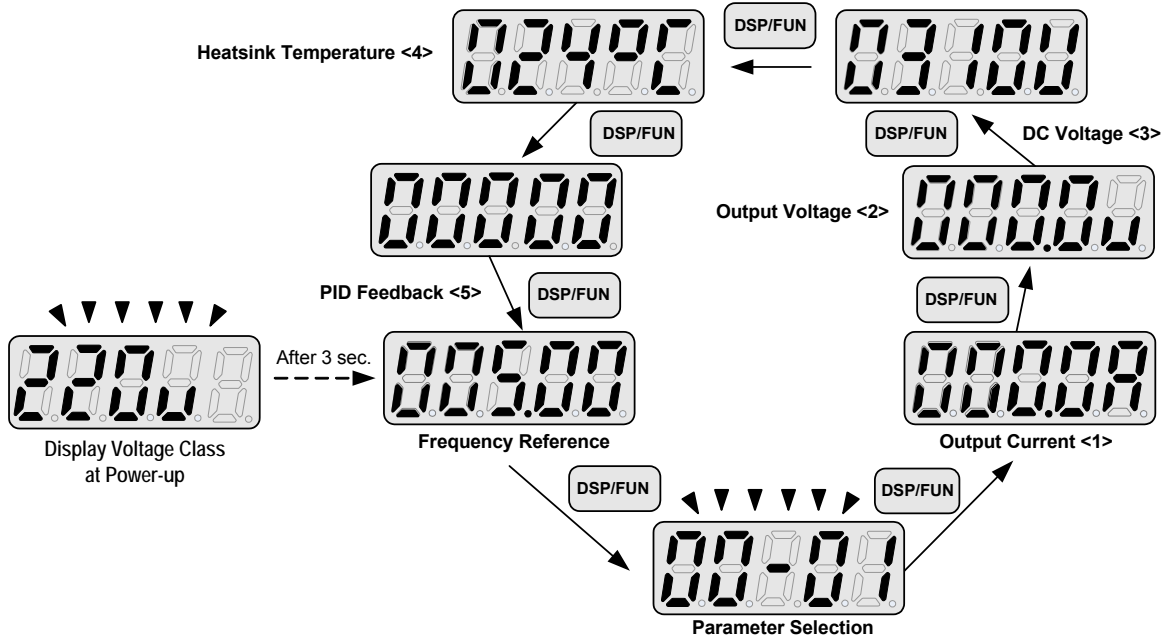

4.1.5 Modifying Parameters/ Set Frequency Reference

Example: Modifying Parameters

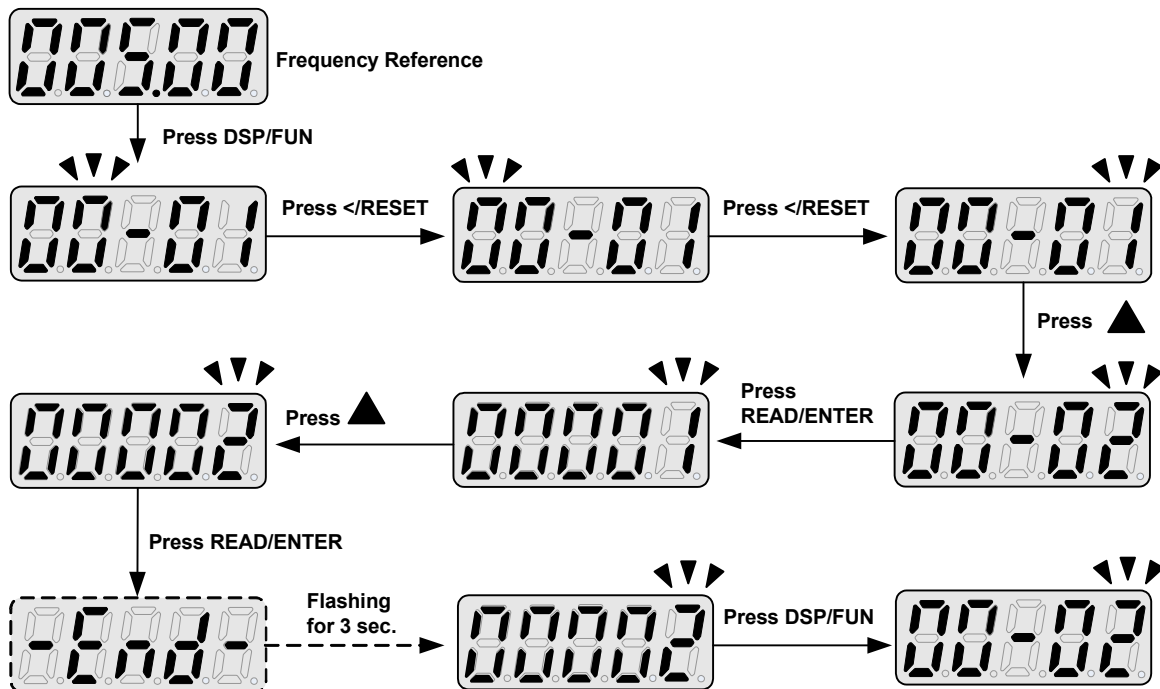

Example: Set Frequency Reference

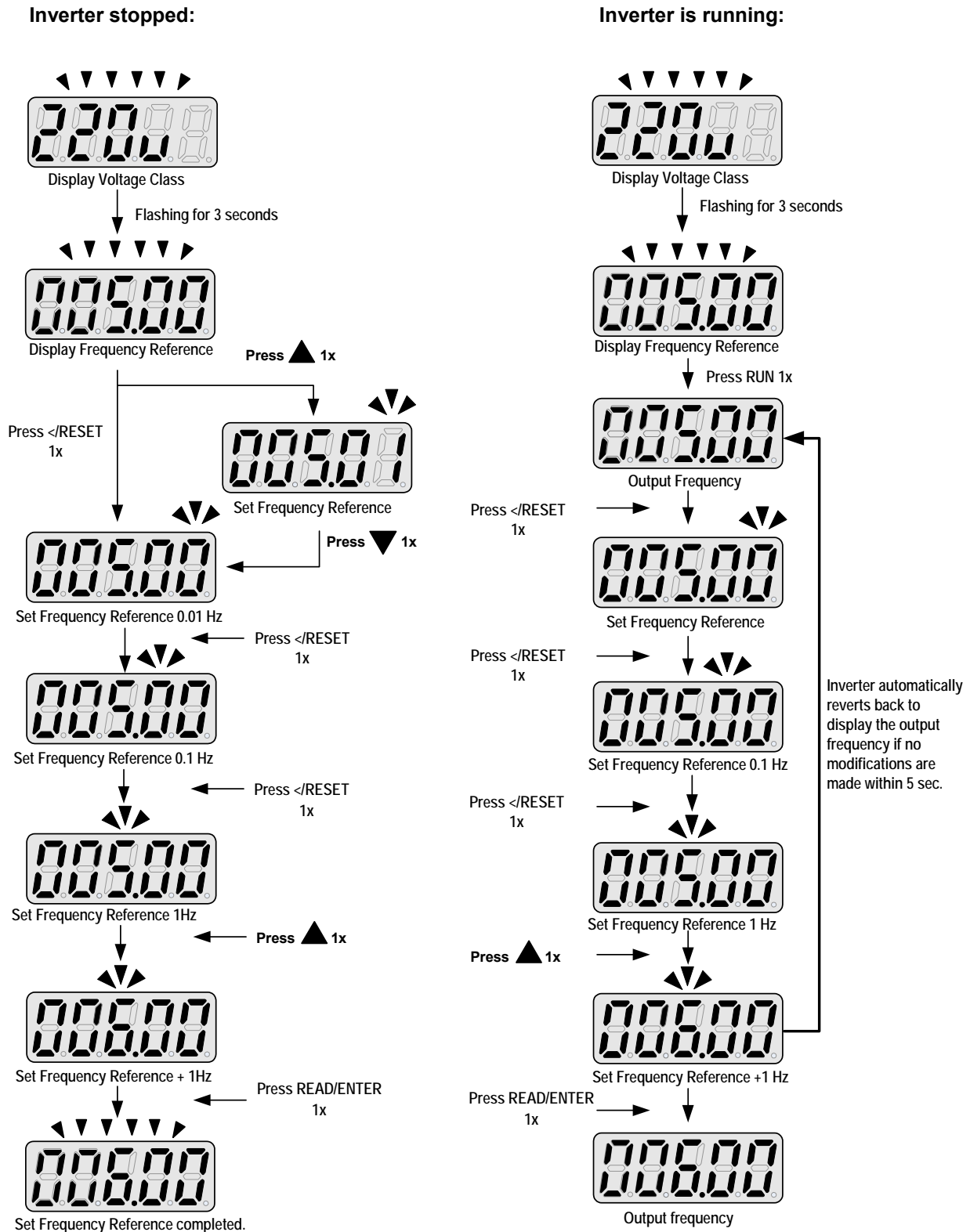

Note: When upper or lower limit is reached during editing of the frequency reference, the edit value will automatically rollover from the lower limit to the upper limit or from the upper limit to the lower limit.

4.1.6 Operation Control

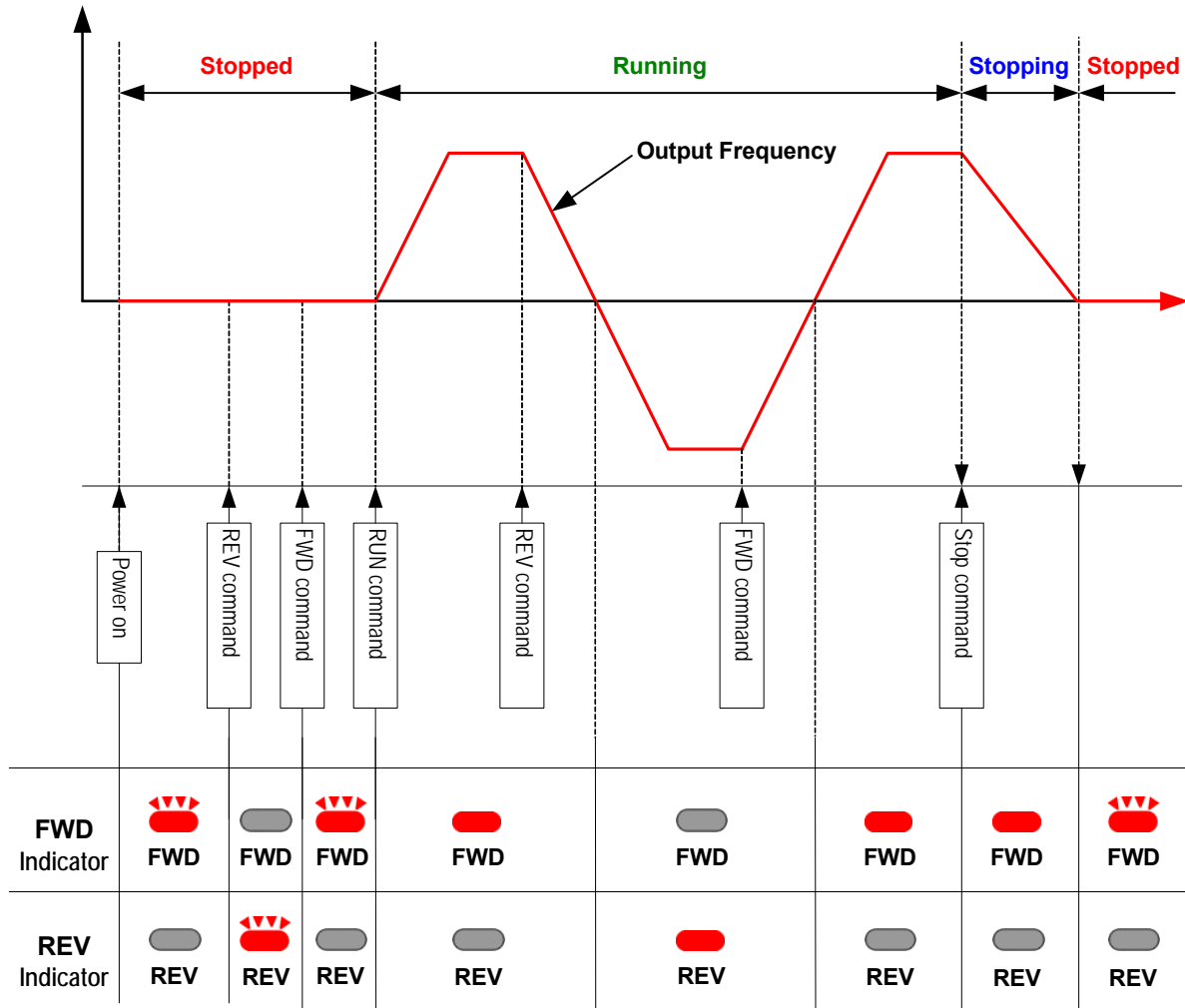

4.2 Parameters

Parameter group	Group Name
Group 00	Basic Parameters
Group 01	V/F Control Parameters
Group 02	IM Motor Parameters
Group 03	External Digital Input and Output Parameters
Group 04	External Analog Input and Output Parameters
Group 05	Multi-Speed Parameters
Group 06	Automatic Program Operation Parameters
Group 07	Start /Stop Parameters
Group 08	Protection Parameters
Group 09	Communication Parameters
Group 10	PID Parameters
Group 11	Auxiliary Parameters
Group 12	Monitoring Parameters
Group 13	Maintenance Parameters
Group 14	Reserved
Group 15	Reserved
Group 16	Reserved
Group 17	Automatic Tuning Parameters
Group 18	Slip Compensation Parameters
Group 19	Wobble Frequency Parameters
Group 20	Speed Control Parameters
Group 21	Torque And Position Control Parameters

Parameter Attribute	
*1	Parameters can be changed during run operation.
*3	Parameter will not reset to default during a factory reset (initialization).
*4	Read-only parameter
*6	Parameter will be displayed only in LED keypad.
*8	When 13-08 setting is changed, the value will be also changed.

Group 00: Basic Parameters								
Code	Parameter Name	Setting Range	Default	Unit	Control mode			Attribute
					V/F	SLV	SLV2	
00-00	Control Mode Selection	0: V/F	0	-	0	0	0	*3
		1: Reserved						
		2: SLV						
		3: Reserved						
		4: Reserved						
		5: Reserved						
6: SLV2								
00-01	Motor's Rotation Direction	0: Forward	0	-	0	0	0	*1
		1: Reverse						
00-02	Main Run Command Source Selection	0: Keypad	1	-	0	0	0	
		1: External Terminal (Control Circuit)						
		2: Communication Control (RS-485)						
00-03	Alternative Run Command Selection	0: Keypad	2	-	0	0	0	
		1: External Terminal (Control Circuit)						
		2: Communication Control (RS-485)						
00-04	Reserved							
00-05	Main Frequency Command Source Selection	0: Keypad	1	-	0	0	0	
		1: External Terminal (Analog 1)						
		2: Terminal Command UP/DOWN						
		3: Communication Control (RS-485)						
		4: Pulse Input						
		5: Reserved						
		6: Reserved						
		7: AI2 Auxiliary Frequency						
8: Potentiometer on Keypad								
00-06	Alternative Frequency Source Selection	0: Keypad	3	-	0	0	0	
		1: External Terminal (Analog 1)						
		2: Terminal Command UP/DOWN						
		3: Communication Control (RS-485)						
		4: Pulse Input						
		5: Reserved						
		6: Reserved						
		7: AI2 Auxiliary Frequency						
8: Potentiometer on Keypad								
00-07	Main and Alternative Frequency Command Modes	0: Main Frequency	0	-	0	0	0	
		1: Main frequency + Alternative Frequency						
00-08	Communication Frequency Command Range	0.00~599.00	0.00	Hz	0	0	0	

Group 00: Basic Parameters								
Code	Parameter Name	Setting Range	Default	Unit	Control mode			Attribute
					V/F	SLV	SLV2	
00-09	Communication Frequency Command Memory Selection	0: Don't save when power supply is off. (00-08)	0	-	0	0		
		1: Save when power is off. (00-08)						
00-10	Minimum frequency detection	0: Show warning if lower than minimum frequency	0	-	0	0	0	
		1: Run as minimum frequency if lower than minimum frequency						
00-11	PID Lower Limit of Frequency Selection	0: PID Sleep Limit is Lower Limit of Frequency	0	-	0	0	0	
		1: PID Sleep Limit is 0Hz						
00-12	Upper limit Frequency	0.1~109.0	100.0	%	0	0	0	
00-13	Lower limit Frequency	0.0~109.0	0.0	%	0	0	0	
00-14	Acceleration Time 1	0.1~6000.0	*Note1	s	0	0	0	*1
00-15	Deceleration Time 1	0.1~6000.0	*Note1	s	0	0	0	*1
00-16	Acceleration Time 2	0.1~6000.0	*Note1	s	0	0	0	*1
00-17	Deceleration Time 2	0.1~6000.0	*Note1	s	0	0	0	*1
00-18	*Jog Frequency	0.00~599.00	6.00	Hz	0	0	0	*1
00-19	Jog Acceleration Time	0.1~0600.0	*Note1	s	0	0	0	*1
00-20	Jog Deceleration Time	0.1~0600.0	*Note1	s	0	0	0	*1
00-21	Acceleration time 3	0.1~6000.0	*Note1	s	0	0	0	*1
00-22	Deceleration time 3	0.1~6000.0	*Note1	s	0	0	0	*1
00-23	Acceleration time 4	0.1~6000.0	*Note1	s	0	0	0	*1
00-24	Deceleration time 4	0.1~6000.0	*Note1	s	0	0	0	*1
00-25	Switch-Over Frequency of Acc/Dec Time 1 and Time 4	0.00~599.00	0.0	Hz	0	0	0	
00-26	Emergency Stop Time	0.1~6000.0	5.0	s	0	0	0	
00-27	Reserved							
00-28	Command Characteristic selection of master frequency	0: Positive Characteristic (0~10V/4~20mA is corresponding to 0~100%)	0	-	0	0	0	
		1: Negative Characteristic (0~10V/4~20mA is						

Group 00: Basic Parameters								
Code	Parameter Name	Setting Range	Default	Unit	Control mode			Attribute
					V/F	SLV	SLV2	
		corresponding to 100~0%)						
00-29	Reserved							
00-30	Reserved							
00-31	Reserved							
00-32	Application Selection Presets *Note2	0: General	0	-	O	O	O	
		1: Reserved						
		2: Conveyor						
		3: Exhaust Fan						

* Note1: Refer to the following attachment 1 (The initial value (s) of Accel. & Decel), Page4-55

*Note2: Before to set up 00-32 Application, it should do initialized setting (parameter 13-08) first. When setting 00-32, the I/O port function changed automatically. To avoid accident, be sure to confirm the I/O port signal of inverter and external terminal control.

Group 01: V/F Control Parameters								
Code	Parameter Name	Setting Range	Default	Unit	Control mode			Attribute
					V/F	SLV	SLV2	
01-00	V/F Curve Selection	0~FF	F	-	O	X	O	*3
01-01	Reserved							
01-02	Maximum Output Frequency of Motor 1	4.8~599.0	50.0/ 60.0	Hz	O	O	O	*8
01-03	Maximum Output Voltage of Motor 1	380V: 0.2~480.0	380.0	V	O	X	O	*8
01-04	Middle Output Frequency 2 of Motor 1	0.0~599.0	0.0	Hz	O	X	O	
01-05	Middle Output Voltage 2 of Motor 1	380V: 0.0~480.0	0.0	V	O	X	O	*8
01-06	Middle Output Frequency 1 of Motor 1	0.0~599.0	3.0	Hz	O	X	O	
01-07	Middle Output Voltage 1 of Motor 1	380V: 0.0~480.0	*	V	O	X	O	*8
01-08	Minimum Output Frequency of Motor 1	0.0~599.0	VF:1.5	Hz	O	O	O	
			SLV: 0.6					
			SLV2: 1.0					
01-09	Minimum Output Voltage of Motor 1	380V: 0.0~480.0	*	V	O	X	O	*8
01-10	Torque Compensation Gain	0.0~2.0	0.5	-	O	X	O	*1

Group 01: V/F Control Parameters								
Code	Parameter Name	Setting Range	Default	Unit	Control mode			Attribute
					V/F	SLV	SLV2	
01-11	Selection of Torque Compensation Mode	0: Torque Compensation Mode 0	0	-	O	X	X	
		1: Torque Compensation Mode 1						
01-12	Base Frequency of Motor 1	4.8~599.0	50.0/ 60.0	Hz	O	O	O	*8
01-13	Base Output Voltage of Motor 1	380V: 0.0~480.0	380.0	V	O	X	O	*8
01-14	Input Voltage Setting	380V: 310.0~480.0	380.0	V	O	O	O	*8
01-15	Torque Compensation Time	0~10000	200	ms	O	X	O	
01-16	Maximum Output Frequency of Motor 2	4.8~599.0	50.0/ 60.0	Hz	O	X	X	*8
01-17	Maximum Output Voltage of Motor 2	380V: 0.2~480.0	380.0	V	O	X	X	*8
01-18	Middle Output Frequency 2 of Motor 2	0.0~599.0	0.0	Hz	O	X	X	
01-19	Middle Output Voltage 2 of Motor 2	380V: 0.0~480.0	0.0	V	O	X	X	
01-20	Middle Output Frequency 1 of Motor 2	0.0~599.0	3.0	Hz	O	X	X	
01-21	Middle Output Voltage 1 of Motor 2	380V: 0.0~480.0	KVA *Note1	V	O	X	X	
01-22	Minimum Output Frequency of Motor 2	0.0~599.0	1.5	Hz	O	X	X	
01-23	Minimum Output Voltage of Motor 2	380V: 0.0~480.0	KVA *Note1	V	O	X	X	
01-24	Base Frequency of Motor 2	4.8~599.0	50.0/ 60.0	Hz	O	X	X	*8
01-25	Base Output Voltage of Motor 2	380V: 0.0~480.0	380.0	V	O	X	X	*8
01-26	V/F Curve Selection of Motor 2	0~FF	F	-	O	X	X	*3

*Note1: KVA: The default value of this parameter will be changed by different capacities of inverter.

Group 02: IM Motor Parameters								
Code	Parameter Name	Setting Range	Default	Unit	Control mode			Attribute
					V/F	SLV	SLV2	
02-00	No-Load Current of Motor1	0.01~600.00	-	A	O	X	O	
02-01	Rated Current of Motor1	Modes of V/F is 10%~200% of inverter's rated current. Modes of SLV is 25%~200% of inverter's rated current.	-	A	O	O	O	
02-02	Reserved							
02-03	Rated Rotation Speed of Motor1	0~60000	-	Rpm	O	O	O	
02-04	Rated Voltage of Motor1	380V: 100.0~480.0	380.0	V	O	O	O	*8
02-05	Rated Power of Motor1	0.01~600.00	-	kW	O	O	O	
02-06	Rated Frequency of Motor1	4.8~599.0	50.0/ 60.0	Hz	O	O	O	*8
02-07	Poles of Motor 1	2~16(Even)	4	-	O	O	O	
02-08	Reserved							
02-09	Excitation Current of Motor 1	15%~70% of Motor Rated Current	-	%	X	O	X	
02-10	Core Saturation Coefficient 1 of Motor 1	1~100	-	%	X	O	X	
02-11	Core Saturation Coefficient 2 of Motor 1	1~100	-	%	X	O	X	
02-12	Core Saturation Coefficient 3 of Motor 1	80~300	-	%	X	O	X	
02-13	Core loss of Motor 1	0.0~15.0	-	%	O	X	O	
02-14	Reserved							
02-15	Resistance between Wires of Motor 1	0.001~60.000	-	Ω	O	O	O	
02-16	Reserved							
02-17								
02-18								
02-19	No-Load Voltage of Motor 1	380V: 100~480	-	V	X	O	X	
02-20	No-Load Current of Motor 2	0.01~600.00	-	A	O	X	X	

Group 02: IM Motor Parameters								
Code	Parameter Name	Setting Range	Default	Unit	Control mode			Attribute
					V/F	SLV	SLV2	
02-21	Rated Current of Motor 2	10%~200% of inverter's rated current	-	A	O	X	X	
02-22	Rated Rotation Speed of Motor 2	0~60000	-	Rpm	O	X	X	
02-23	Rated Voltage of Motor 2	380V: 100.0~480.0	380.0	V	O	X	X	*8
02-24	Rated Power of Motor 2	0.01~600.00	-	kW	O	X	X	
02-25	Rated Frequency of Motor 2	4.8~599.0	50.0/ 60.0	Hz	O	X	X	*8
02-26	Poles of Motor 2	2~16 (Even)	4	-	O	X	X	
02-27 ~ 02-31	Reserved							
02-32	Resistance between Wires of Motor 2	0.001~60.000	-	Ω	O	X	X	
02-33	Proportion of Motor 1 Leakage Inductance	0.1~15.0	3.4	%	X	O	X	
02-34	Motor 1 Slip Frequency	0.10~20.00	1.00	Hz	X	O	X	
02-35 ~ 02-37	Reserved							

Group 03: External Digital Input and Output Parameters								
Code	Parameter Name	Setting Range	Default	Unit	Control mode			Attribute
					V/F	SLV	SLV2	
03-00	Multi-Function Terminal Function Setting-S1	0: 2-Wire Sequence (ON: Forward Run Command)	0	-	<input type="checkbox"/>	<input type="checkbox"/>	<input type="checkbox"/>	
		1: 2-Wire Sequence (ON: Reverse Run Command)			<input type="checkbox"/>	<input type="checkbox"/>	<input type="checkbox"/>	
		2: Multi-Speed/Position Setting Command 1			<input type="checkbox"/>	<input type="checkbox"/>	<input type="checkbox"/>	
		3: Multi-Speed/Position Setting Command 2			<input type="checkbox"/>	<input type="checkbox"/>	<input type="checkbox"/>	
		4: Multi-Speed/Position Setting Command 3			<input type="checkbox"/>	<input type="checkbox"/>	<input type="checkbox"/>	
		5: Multi-Speed/Position Setting Command 4			<input type="checkbox"/>	<input type="checkbox"/>	<input type="checkbox"/>	
03-01	Multi-Function Terminal Function Setting-S2	6: Forward Jog Run Command	1	-	<input type="checkbox"/>	<input type="checkbox"/>	<input type="checkbox"/>	
		7: Reverse Jog Run Command			<input type="checkbox"/>	<input type="checkbox"/>	<input type="checkbox"/>	
		8: UP Frequency Increasing Command			<input type="checkbox"/>	<input type="checkbox"/>	<input type="checkbox"/>	
		9: DOWN Frequency Decreasing Command			<input type="checkbox"/>	<input type="checkbox"/>	<input type="checkbox"/>	
		10: Acceleration/Deceleration Time Selection 1			<input type="checkbox"/>	<input type="checkbox"/>	<input type="checkbox"/>	
		11: Inhibit Acceleration/Deceleration Command			<input type="checkbox"/>	<input type="checkbox"/>	<input type="checkbox"/>	
03-02	Multi-Function Terminal Function Setting-S3	12: Main/ Alternative Run Switch Function	2	-	<input type="checkbox"/>	<input type="checkbox"/>	<input type="checkbox"/>	
		13: Main/ Alternative Frequency Switch Function			<input type="checkbox"/>	<input type="checkbox"/>	<input type="checkbox"/>	
		14: Emergency Stop (decelerate to zero and stop)			<input type="checkbox"/>	<input type="checkbox"/>	<input type="checkbox"/>	
		15: External Baseblock Command (rotation freely to stop)			<input type="checkbox"/>	<input type="checkbox"/>	<input type="checkbox"/>	
		16: PID Control Disable			<input type="checkbox"/>	<input type="checkbox"/>	<input type="checkbox"/>	
		17: Fault Reset (RESET)			<input type="checkbox"/>	<input type="checkbox"/>	<input type="checkbox"/>	
03-03	Multi-Function Terminal Function Setting-S4	18: Reserved	3	-	-	-	-	
		19: Speed Search 1 (from the maximum frequency)			<input type="checkbox"/>	<input type="checkbox"/>	<input type="checkbox"/>	
		20: Manual Energy Saving Function			<input type="checkbox"/>	X	X	
		21: PID Integral Reset			<input type="checkbox"/>	<input type="checkbox"/>	<input type="checkbox"/>	
		22~24 : Reserved			-	-	-	
		25: External Fault			<input type="checkbox"/>	<input type="checkbox"/>	<input type="checkbox"/>	

Group 03: External Digital Input and Output Parameters								
Code	Parameter Name	Setting Range	Default	Unit	Control mode			Attribute
					V/F	SLV	SLV2	
		26: 3-Wire Sequence (Forward/Reverse command)			0	0	0	
		27: Local/ Remote Selection			0	0	0	
03-04	Multi-Function Terminal Function Setting-S5	28: Remote Mode Selection	4	-	0	0	0	
		29: Jog Frequency Selection			0	0	0	
		30: Acceleration/ Deceleration Time Selection 2			0	0	0	
		31: Inverter Overheating Warning			0	0	0	
		32: Sync Command			0	0	0	
		33: DC Braking			0	0	0	
		34: Speed Search 2 (from the frequency command)			0	0	0	
		35: Timing Function Input			0	0	0	
		36: PID Soft Start Disable			0	0	0	
03-05	Multi-Function Terminal Function Setting-S6	37: Traversing Operation	17	-	0	X	0	
		38: Upper Deviation of Traverse Operation			0	X	0	
		39: Lower Deviation of Traverse Operation			0	X	0	
		40: Switching between Motor 1/Motor 2			0	X	X	
		41: PID Sleep			0	0	0	
		42~46 : Reserved			-	-	-	
03-06	Reserved	47: Fire mode(Forced Operation mode)	-	-	0	0	0	
		48: KEB Acceleration			0	X	0	
		49: Parameters Writing Allowable			0	0	0	
		50: Unattended Start Protection (USP)			0	0	0	
03-07	Reserved	51~52: Reserved	-	-	-	-	-	
		53: 2-Wire Self Holding Mode (Stop Command)			0	0	0	
		54: Reserved			-	-	-	
		55: Reserved			-	-	-	
		56: Reserved			-	-	-	
		57: Reserved			-	-	-	
		58: Safety Function			0	0	0	
		59: Reserved			-	-	-	
		60: Reserved			-	-	-	
		61: Reserved			-	-	-	

Group 03: External Digital Input and Output Parameters								
Code	Parameter Name	Setting Range	Default	Unit	Control mode			Attribute
					V/F	SLV	SLV2	
		62: EPS Function			<input type="checkbox"/>	<input type="checkbox"/>	<input type="checkbox"/>	
03-08	(S1~S6) DI Scan Time	0: Scan Time 4ms 1: Scan Time 8ms	1	-	<input type="checkbox"/>	<input type="checkbox"/>	<input type="checkbox"/>	
03-09	Multi-Function Terminal S1-S4 Type Selection	xxx0b: S1 A Contact xxx1b: S1 B Contact xx0xb: S2 A Contact xx1xb: S2 B Contact x0xxb: S3 A Contact x1xxb: S3 B Contact 0xxb: S4 A Contact 1xxb: S4 B Contact	0000b	-	<input type="checkbox"/>	<input type="checkbox"/>	<input type="checkbox"/>	
03-10	Multi-Function Terminal S5-S6 Type Selection	xxx0b: S5 A Contact xxx1b: S5 B Contact xx0xb: S6 A Contact xx1xb: S6 B Contact	0000b	-	<input type="checkbox"/>	<input type="checkbox"/>	<input type="checkbox"/>	
03-11	Relay (R1A-R1C) Output	0: During Running	1	-	<input type="checkbox"/>	<input type="checkbox"/>	<input type="checkbox"/>	
		1: Fault Contact Output			<input type="checkbox"/>	<input type="checkbox"/>	<input type="checkbox"/>	
		2: Frequency Agree			<input type="checkbox"/>	<input type="checkbox"/>	<input type="checkbox"/>	
		3: Setting Frequency Agree			<input type="checkbox"/>	<input type="checkbox"/>	<input type="checkbox"/>	
		4: Frequency Detection 1 (\cong 03-13+03-14)			<input type="checkbox"/>	<input type="checkbox"/>	<input type="checkbox"/>	
		5: Frequency Detection 2 (\cong 03-13+03-14)			<input type="checkbox"/>	<input type="checkbox"/>	<input type="checkbox"/>	
		6: Automatic Restart			<input type="checkbox"/>	<input type="checkbox"/>	<input type="checkbox"/>	
		7: Reserved			-	-	-	
		8: Reserved			-	-	-	
		9: Baseblock			<input type="checkbox"/>	<input type="checkbox"/>	<input type="checkbox"/>	
		10: Reserved			-	-	-	
		11: Reserved			-	-	-	
		12: Over-Torque Detection			<input type="checkbox"/>	<input type="checkbox"/>	<input type="checkbox"/>	
		13: Current Agree			<input type="checkbox"/>	<input type="checkbox"/>	<input type="checkbox"/>	
		14: Mechanical Braking Control (03-17~18)			<input type="checkbox"/>	<input type="checkbox"/>	<input type="checkbox"/>	
		15: Reserved			-	-	-	
		16: Reserved			-	-	-	
		17: Reserved			-	-	-	
		18: Reserved			-	-	-	
19: Reserved	-	-	-					
03-12 (Note)	Relay (R2A-R2C) Output	20: Zero Speed	0	-	<input type="checkbox"/>	<input type="checkbox"/>	<input type="checkbox"/>	
		21: Inverter Ready			<input type="checkbox"/>	<input type="checkbox"/>	<input type="checkbox"/>	
		22: Under Voltage Detection			<input type="checkbox"/>	<input type="checkbox"/>	<input type="checkbox"/>	
		23: Source of Operation Command			<input type="checkbox"/>	<input type="checkbox"/>	<input type="checkbox"/>	
		24: Source of Frequency Command			<input type="checkbox"/>	<input type="checkbox"/>	<input type="checkbox"/>	
		25: Low Torque Detection			<input type="checkbox"/>	<input type="checkbox"/>	<input type="checkbox"/>	

Group 03: External Digital Input and Output Parameters

Code	Parameter Name	Setting Range	Default	Unit	Control mode			Attribute
					V/F	SLV	SLV2	
		26: Frequency Reference Missing			○	○	○	
		27: Timing Function Output			○	○	○	
		28: Traverse Operation UP Status			○	×	○	
		29 : During Traverse Operation Status			○	×	○	
		30 : Motor 2 Selection			○	○	○	
		31: Reserved			×	×	×	
		32: Communication Control Contacts			○	○	○	
		33: Reserved			-	-	-	
		34: Reserved			-	-	-	
		35: Reserved			-	-	-	
		36: Reserved			-	-	-	
		37: PID Feedback Loss Detection Output			○	○	○	
		38: Brake Release			×	○	×	
		39: Frequency Detection 1 (dedicated for Crane)			○	○	×	
		40: Reserved			-	-	-	
		41: Reserved			-	-	-	
		42: Reserved			-	-	-	
		43: Reserved			-	-	-	
		44: Reserved			-	-	-	
		45: PID sleep			○	○	○	
		46: Reserved			-	-	-	
		47: Reserved			-	-	-	
		48: Reserved			-	-	-	
		49: Reserved			-	-	-	
		50: Frequency Detection 3 (≡ 03-44+03-45)			○	○	○	
		51: Frequency Detection 4 (≡ 03-44+03-45)			○	○	○	
		52: Frequency Detection 5 (≡ 03-46+03-47)			○	○	○	
		53: Frequency Detection 6 (≡ 03-46+03-47)			○	○	○	
		54: Reserved			-	-	-	
		57: Low Current Detection			○	○	○	
03-13	Frequency Detection Level	0.0~599.0	0.0	Hz	○	○	○	
03-14	Frequency Detection Width	0.1~25.5	2.0	Hz	○	○	○	
03-15	Current Agree Level	0.1~999.9	0.1	A	○	○	○	

Group 03: External Digital Input and Output Parameters								
Code	Parameter Name	Setting Range	Default	Unit	Control mode			Attribute
					V/F	SLV	SLV2	
03-16	Delay Time of Current Agree Detection	0.1~10.0	0.1	s	O	O	O	
03-17	**Mechanical Braking Release Level	0.00~599.00	0.00	Hz	O	O	O	
03-18	**Mechanical Braking Level Set	0.00~599.00	0.00	Hz	O	O	O	
03-19	Relay (R1A-R2C) Type	xxx0b: R1 A Contact xxx1b: R1 B Contact xx0xb: R2 A Contact xx1xb: R2 B Contact	0000b	-	O	O	O	
03-20 ~ 03-26	Reserved							
03-27	UP/DOWN Frequency Hold/Adjust Selection	0: Hold last set frequency when stopped	0	-	O	O	O	
		1: Set frequency to 0 when stopped						
		2: Allow speed changes from last set frequency when stopped						
		3: Refresh frequency at acceleration.						
03-28	Photo-coupler Output	Range and definition are the same as those of 03-11, 03-12	0	-	O	O	O	
03-29	Photo-coupler Output Selection	xxx0b: Photo-coupler A Contact xxx1b: Photo-coupler B Contact	0000b	-	O	O	O	
03-30	Selection of Pulse Input	0: General Pulse Input	0	-	O	O	O	
		1: PWM						
03-31	Scale of Pulse Input	Depending on the setting of 03-30 03-30 = 0: 50~32000Hz 03-30 = 1: 10~1000Hz	1000	Hz	O	O	O	*1
03-32	Pulse Input Gain	0.0~1000.0	100	%	O	O	O	*1
03-33	Pulse Input Bias	-100.0~100.0	0.0	%	O	O	O	*1
03-34	Filter Time of Pulse Input	0.00~2.00	0.1	Sec	O	O	O	*1
03-35	Function Setting of Pulse Output	1: Frequency Command	2	-	O	O	O	*1
		2: Output Frequency						
		3: Output Frequency after Soft-Start						
		4: Motor Speed						

Group 03: External Digital Input and Output Parameters								
Code	Parameter Name	Setting Range	Default	Unit	Control mode			Attribute
					V/F	SLV	SLV2	
		5: PID Feedback						
		6: PID Input						
		7: Reserved						
03-36	Scale of Pulse Output	1~32000	1000	Hz	O	O	O	*1
03-37	Timer ON Delay (DIO)	0.0~6000.0	0.0	s	O	O	O	
03-38	Timer OFF Delay (DIO)	0.0~6000.0	0.0	s	O	O	O	
03-39	Reserved							
03-40	Up/Down Frequency Width Setting	0.00~5.00	0.00	Hz	O	O	O	
03-41	Torque Detection Level	0~150	10	%	X	O	X	
03-42	Brake Release Delay Time	0.00~65.00	0.00	s	X	O	X	
03-43	UP/DOWN Acceleration/ Deceleration Selection	0: Acceleration/ Deceleration Time 1	0	-	O	O	O	
		1: Acceleration/ Deceleration Time 2						
03-44	Frequency Detection Level 2	0.0~599.0	0.0	Hz	O	O	O	
03-45	Frequency Detection Width 2	0.1~25.5	2.0	Hz	O	O	O	
03-46	Frequency Detection Level 3	0.0~599.0	0.0	Hz	O	O	O	
03-47	Frequency Detection Width 3	0.1~25.5	2.0	Hz	O	O	O	
03-48	Low Current Detection Level	0.0~999.9	0.1	A	O	O	O	
03-49	Low Current Detection Delay Time	0.00~655.35	0.01	Sec	O	O	O	

Group 04: External Analog Input and Output Parameters								
Code	Parameter Name	Setting Range	Default	Unit	Control mode			Attribute
					V/F	SLV	SLV2	
04-00	AI Input Signal Type	0: AI1:0~10V AI2: 0~10V / 0~20mA	1	-	0	0	0	
		1: AI1:0~10V AI2: 4~20mA/ 2~10V						
		2: AI1: -10~10V AI2: 0~10V/ 0~20mA						
		3: AI1: -10~10V AI2: 4~20mA/ 2~10V						
04-01	AI1 Signal Scanning and Filtering Time	0.00~2.00	0.03	s	0	0	0	
04-02	AI1 Gain	0.0~1000.0	100.0	%	0	0	0	*1
04-03	AI1 Bias	-100.0~100.0	0	%	0	0	0	*1
04-04	Reserved							
04-05	AI2 Function Setting	0: Auxiliary Frequency	10	-	0	0	0	
		1: Frequency Reference Gain						
		2: Frequency Reference Bias						
		3: Output Voltage Bias						
		4: Coefficient of Acceleration and Deceleration Reduction						
		5: DC Braking Current						
		6: Over-Torque Detection Level						
		7: Stall Prevention Level During Running						
		8: Frequency Lower Limit						
		9: Jump Frequency 4						
		10: Added to AI1						
		11: Positive torque limit						
		12: Negative torque limit						
		13: Regenerative Torque Limit						
		14: Positive / Negative Torque Limit						
		15: Reserved						
		16: Torque Compensation						
17: PTC Overheat Protection								

Group 04: External Analog Input and Output Parameters								
Code	Parameter Name	Setting Range	Default	Unit	Control mode			Attribute
					V/F	SLV	SLV2	
04-06	AI2 Signal Scanning and Filtering Time	0.00~2.00	0.03	s	<input type="radio"/>	<input type="radio"/>	<input type="radio"/>	
04-07	AI2 Gain	0.0~1000.0	100.0	%	<input type="radio"/>	<input type="radio"/>	<input type="radio"/>	*1
04-08	AI2 Bias	-100.0~100.0	0	%	<input type="radio"/>	<input type="radio"/>	<input type="radio"/>	*1
04-09 ~ 04-10	Reserved							
04-11	AO1 Function Setting	0: Output Frequency	0	-	<input type="radio"/>	<input type="radio"/>	<input type="radio"/>	
		1: Frequency Command			<input type="radio"/>	<input type="radio"/>	<input type="radio"/>	
		2: Output Voltage			<input type="radio"/>	<input type="radio"/>	<input type="radio"/>	
		3: DC Voltage			<input type="radio"/>	<input type="radio"/>	<input type="radio"/>	
		4: Output Current			<input type="radio"/>	<input type="radio"/>	<input type="radio"/>	
		5: Output Power			<input type="radio"/>	<input type="radio"/>	<input type="radio"/>	
		6: Motor Speed			<input type="radio"/>	<input type="radio"/>	<input type="radio"/>	
		7: Output Power Factor			<input type="radio"/>	<input type="radio"/>	<input type="radio"/>	
		8: AI1 Input			<input type="radio"/>	<input type="radio"/>	<input type="radio"/>	
		9: AI2 Input			<input type="radio"/>	<input type="radio"/>	<input type="radio"/>	
		10: Torque Command			<input type="checkbox"/>	<input type="radio"/>	<input type="checkbox"/>	
		11: q-axis Current			<input type="checkbox"/>	<input type="radio"/>	<input type="checkbox"/>	
		12: d-axis Current			<input type="checkbox"/>	<input type="radio"/>	<input type="checkbox"/>	
		13: Reserved			-	-	-	
		14: Reserved			-	-	-	
		15: Reserved			-	-	-	
		16: Reserved			-	-	-	
		17: q-axis Voltage			<input type="checkbox"/>	<input type="radio"/>	<input type="checkbox"/>	
		18: d-axis Voltage			<input type="checkbox"/>	<input type="radio"/>	<input type="checkbox"/>	
		19: Reserved			-	-	-	
		20: Reserved			-	-	-	
		21: PID Input			<input type="radio"/>	<input type="radio"/>	<input type="radio"/>	
		22: PID Output			<input type="radio"/>	<input type="radio"/>	<input type="radio"/>	
		23: PID Target Value			<input type="radio"/>	<input type="radio"/>	<input type="radio"/>	
		24: PID Feedback Value			<input type="radio"/>	<input type="radio"/>	<input type="radio"/>	
		25: Output Frequency of the Soft Starter			<input type="radio"/>	<input type="radio"/>	<input type="radio"/>	
		26: Reserved			-	-	-	
		27: Reserved			-	-	-	
28: Communication control	<input type="radio"/>	<input type="radio"/>	<input type="radio"/>					
04-12	AO1 Gain	0.0~1000.0	100.0	%	<input type="radio"/>	<input type="radio"/>	<input type="radio"/>	*1
04-13	AO1 Bias	-100.0~100.0	0	%	<input type="radio"/>	<input type="radio"/>	<input type="radio"/>	*1
04-14	Reserved							
04-15	Reserved							
04-16	AO2 Function Setting	Range and definition are the same as those of 04-11.	4	-	<input type="radio"/>	<input type="radio"/>	<input type="radio"/>	

Group 04: External Analog Input and Output Parameters

Code	Parameter Name	Setting Range	Default	Unit	Control mode			Attribute
					V/F	SLV	SLV2	
04-17	AO2 Gain	0.0~1000.0	100.0	%	O	O	O	*1
04-18	AO2 Bias	-100.0~100.0	0	%	O	O		*1
04-19	AO2 Output Signal Type	0: AO2 0~10V	0	-	O	O	O	
		1: AO2 4~20mA						
04-20	Filter Time of AO Signal Scan	0.00~0.50	0.00	s	O	O	O	*1

Group 05: Multi-Speed Parameters

Code	Parameter Name	Setting Range	Default	Unit	Control mode			Attribute
					V/F	SLV	SLV2	
05-00	Acceleration and Deceleration Selection of Multi-Speed	0: Acceleration and deceleration time are set by 00-14 ~ 00-24	0	-	O	O	O	
		1: Acceleration and Deceleration Time are set by 05-17 ~ 05-48						
05-01	*Frequency Setting of Speed-Stage 0	0.00~599.00	5.00	Hz	O	O	O	*1
05-02	*Frequency Setting of Speed-Stage 1	0.00~599.00	5.00	Hz	O	O	O	*1
05-03	*Frequency Setting of Speed-Stage 2	0.00~599.00	10.00	Hz	O	O	O	*1
05-04	*Frequency Setting of Speed-Stage 3	0.00~599.00	20.00	Hz	O	O	O	*1
05-05	*Frequency Setting of Speed-Stage 4	0.00~599.00	30.00	Hz	O	O	O	*1
05-06	*Frequency Setting of Speed-Stage 5	0.00~599.00	40.00	Hz	O	O	O	*1
05-07	*Frequency Setting of Speed-Stage 6	0.00~599.00	50.00	Hz	O	O	O	*1
05-08	*Frequency Setting of Speed-Stage 7	0.00~599.00	50.00	Hz	O	O	O	*1
05-09	*Frequency Setting of Speed-Stage 8	0.00~599.00	5.00	Hz	O	O	O	*1
05-10	*Frequency Setting of Speed-Stage 9	0.00~599.00	5.00	Hz	O	O	O	*1
05-11	*Frequency Setting of Speed-Stage 10	0.00~599.00	5.00	Hz	O	O	O	*1
05-12	*Frequency Setting of Speed-Stage 11	0.00~599.00	5.00	Hz	O	O	O	*1
05-13	*Frequency Setting of Speed-Stage 12	0.00~599.00	5.00	Hz	O	O	O	*1
05-14	*Frequency Setting of Speed-Stage 13	0.00~599.00	5.00	Hz	O	O	O	*1
05-15	*Frequency Setting of Speed-Stage 14	0.00~599.00	5.00	Hz	O	O	O	*1
05-16	*Frequency Setting of Speed-Stage 15	0.00~599.00	5.00	Hz	O	O	O	*1

Group 05: Multi-Speed Parameters								
Code	Parameter Name	Setting Range	Default	Unit	Control mode			Attribute
					V/F	SLV	SLV2	
05-17	Acceleration Time Setting of Multi Speed 0	0.1~6000.0	10.0	s	O	O	O	
05-18	Deceleration Time Setting of Multi Speed 0	0.1~6000.0	10.0	s	O	O	O	
05-19	Acceleration Time Setting of Multi Speed 1	0.1~6000.0	10.0	s	O	O	O	
05-20	Deceleration Time Setting of Multi Speed 1	0.1~6000.0	10.0	s	O	O	O	
05-21	Acceleration Time Setting of Multi Speed 2	0.1~6000.0	10.0	s	O	O	O	
05-22	Deceleration Time Setting of Multi Speed 2	0.1~6000.0	10.0	s	O	O	O	
05-23	Acceleration Time Setting of Multi Speed 3	0.1~6000.0	10.0	s	O	O	O	
05-24	Deceleration Time Setting of Multi Speed 3	0.1~6000.0	10.0	s	O	O	O	
05-25	Acceleration Time Setting of Multi Speed 4	0.1~6000.0	10.0	s	O	O	O	
05-26	Deceleration Time Setting of Multi Speed 4	0.1~6000.0	10.0	s	O	O	O	
05-27	Acceleration Time Setting of Multi Speed 5	0.1~6000.0	10.0	s	O	O	O	
05-28	Deceleration Time Setting of Multi Speed 5	0.1~6000.0	10.0	s	O	O	O	
05-29	Acceleration Time Setting of Multi Speed 6	0.1~6000.0	10.0	s	O	O	O	
05-30	Deceleration Time Setting of Multi Speed 6	0.1~6000.0	10.0	s	O	O	O	
05-31	Acceleration Time Setting of Multi Speed 7	0.1~6000.0	10.0	s	O	O	O	
05-32	Deceleration Time Setting of Multi Speed 7	0.1~6000.0	10.0	s	O	O	O	
05-33	Acceleration Time Setting of Multi Speed 8	0.1~6000.0	10.0	s	O	O	O	
05-34	Deceleration Time Setting of Multi	0.1~6000.0	10.0	s	O	O	O	

Group 05: Multi-Speed Parameters								
Code	Parameter Name	Setting Range	Default	Unit	Control mode			Attribute
					V/F	SLV	SLV2	
	Speed 8							
05-35	Acceleration Time Setting of Multi Speed 9	0.1~6000.0	10.0	s	O	O	O	
05-36	Deceleration Time Setting of Multi Speed 9	0.1~6000.0	10.0	s	O	O	O	
05-37	Acceleration Time Setting of Multi Speed 10	0.1~6000.0	10.0	s	O	O	O	
05-38	Deceleration Time Setting of Multi Speed 10	0.1~6000.0	10.0	s	O	O	O	
05-39	Acceleration Time Setting of Multi Speed 11	0.1~6000.0	10.0	s	O	O	O	
05-40	Deceleration Time Setting of Multi Speed 11	0.1~6000.0	10.0	s	O	O	O	
05-41	Acceleration Time Setting of Multi Speed 12	0.1~6000.0	10.0	s	O	O	O	
05-42	Deceleration Time Setting of Multi Speed 12	0.1~6000.0	10.0	s	O	O	O	
05-43	Acceleration Time Setting of Multi Speed 13	0.1~6000.0	10.0	s	O	O	O	
05-44	Deceleration Time Setting of Multi Speed 13	0.1~6000.0	10.0	s	O	O	O	
05-45	Acceleration Time Setting of Multi Speed 14	0.1~6000.0	10.0	s	O	O	O	
05-46	Deceleration Time Setting of Multi Speed 14	0.1~6000.0	10.0	s	O	O	O	
05-47	Acceleration Time Setting of Multi Speed 15	0.1~6000.0	10.0	s	O	O	O	
05-48	Deceleration Time Setting of Multi Speed 15	0.1~6000.0	10.0	s	O	O	O	

Group 06: Automatic Program Operation Parameters								
Code	Parameter Name	Setting Range	Default	Unit	Control mode			Attribute
					V/F	SLV	SLV2	
06-00	Automatic Operation Mode Selection	0: Disable	0	-	0	0	0	
		1: Execute a single cycle operation mode. Restart speed is based on the previous stopped speed.						
		2: Execute continuous cycle operation mode. Restart speed is based on the previous stopped speed.						
		3: After the completion of a single cycle, the on-going operation speed is based on the speed of the last stage. Restart speed is based on the previous stopped speed.						
		4: Execute a single cycle operation mode. Restart speed will be based on the speed of stage 0.						
		5: Execute continuous cycle operation mode. Restart speed will be based on the speed of stage 0.						
		6: After the completion of a single cycle, the on-going operation speed is based on the speed of the last stage. Restart speed is based on the speed of stage 0.						
06-01	*Frequency Setting of Operation-Stage 1	0.00~599.00	5.00	Hz	0	0	0	*1
06-02	*Frequency Setting of Operation-Stage 2	0.00~599.00	10.00	Hz	0	0	0	*1
06-03	*Frequency Setting of Operation-Stage 3	0.00~599.00	20.00	Hz	0	0	0	*1
06-04	*Frequency Setting of Operation-Stage 4	0.00~599.00	30.00	Hz	0	0	0	*1
06-05	*Frequency Setting of Operation-Stage 5	0.00~599.00	40.00	Hz	0	0	0	*1
06-06	*Frequency Setting of Operation-Stage 6	0.00~599.00	50.00	Hz	0	0	0	*1
06-07	*Frequency Setting of Operation-Stage 7	0.00~599.00	50.00	Hz	0	0	0	*1
06-08	*Frequency Setting of	0.00~599.00	5.00	Hz	0	0	0	*1

Group 06: Automatic Program Operation Parameters

Code	Parameter Name	Setting Range	Default	Unit	Control mode			Attribute
					V/F	SLV	SLV2	
	Operation-Stage 8							
06-09	*Frequency Setting of Operation-Stage 9	0.00~599.00	5.00	Hz	O	O	O	*1
06-10	*Frequency Setting of Operation-Stage 10	0.00~599.00	5.00	Hz	O	O	O	*1
06-11	*Frequency Setting of Operation-Stage 11	0.00~599.00	5.00	Hz	O	O	O	*1
06-12	*Frequency Setting of Operation-Stage 12	0.00~599.00	5.00	Hz	O	O	O	*1
06-13	*Frequency Setting of Operation-Stage 13	0.00~599.00	5.00	Hz	O	O	O	*1
06-14	*Frequency Setting of Operation-Stage 14	0.00~599.00	5.00	Hz	O	O	O	*1
06-15	*Frequency Setting of Operation-Stage 15	0.00~599.00	5.00	Hz	O	O	O	*1
06-16	Operation Time Setting of Speed-Stage 0	0.0~6000.0	0.0	s	O	O	O	*1
06-17	Operation Time Setting of Speed-Stage 1	0.0~6000.0	0.0	s	O	O	O	*1
06-18	Operation Time Setting of Speed-Stage 2	0.0~6000.0	0.0	s	O	O	O	*1
06-19	Operation Time Setting of Speed-Stage 3	0.0~6000.0	0.0	s	O	O	O	*1
06-20	Operation Time Setting of Speed-Stage 4	0.0~6000.0	0.0	s	O	O	O	*1
06-21	Operation Time Setting of Speed-Stage 5	0.0~6000.0	0.0	s	O	O	O	*1
06-22	Operation Time Setting of Speed-Stage 6	0.0~6000.0	0.0	s	O	O	O	*1
06-23	Operation Time Setting of Speed-Stage 7	0.0~6000.0	0.0	s	O	O	O	*1
06-24	Operation Time Setting of Speed-Stage 8	0.0~6000.0	0.0	s	O	O	O	*1
06-25	Operation Time Setting of Speed-Stage 9	0.0~6000.0	0.0	s	O	O	O	*1
06-26	Operation Time Setting of Speed-Stage 10	0.0~6000.0	0.0	s	O	O	O	*1
06-27	Operation Time Setting of	0.0~6000.0	0.0	s	O	O	O	*1

Group 06: Automatic Program Operation Parameters								
Code	Parameter Name	Setting Range	Default	Unit	Control mode			Attribute
					V/F	SLV	SLV2	
	Speed-Stage 11							
06-28	Operation Time Setting of Speed-Stage 12	0.0~6000.0	0.0	s	O	O	O	*1
06-29	Operation Time Setting of Speed-Stage 13	0.0~6000.0	0.0	s	O	O	O	*1
06-30	Operation Time Setting of Speed-Stage 14	0.0~6000.0	0.0	s	O	O	O	*1
06-31	Operation Time Setting of Speed-Stage 15	0.0~6000.0	0.0	s	O	O	O	*1
06-32	Operation Direction Selection of Speed-Stage 0	0: Stop 1: Forward 2: Reverse	0	-	O	O	O	
06-33	Operation Direction Selection of Speed-Stage 1	0: Stop 1: Forward 2: Reverse	0	-	O	O	O	
06-34	Operation Direction Selection of Speed-Stage 2	0: Stop 1: Forward 2: Reverse	0	-	O	O	O	
06-35	Operation Direction Selection of Speed-Stage 3	0: Stop 1: Forward 2: Reverse	0	-	O	O	O	
06-36	Operation Direction Selection of Speed-Stage 4	0: Stop 1: Forward 2: Reverse	0	-	O	O	O	
06-37	Operation Direction Selection of Speed-Stage 5	0: Stop 1: Forward 2: Reverse	0	-	O	O	O	
06-38	Operation Direction Selection of Speed-Stage 6	0: Stop 1: Forward 2: Reverse	0	-	O	O	O	
06-39	Operation Direction Selection of Speed-Stage 7	0: Stop 1: Forward 2: Reverse	0	-	O	O	O	
06-40	Operation Direction Selection of Speed-Stage 8	0: Stop 1: Forward 2: Reverse	0	-	O	O	O	
06-41	Operation Direction Selection of Speed-Stage 9	0: Stop 1: Forward 2: Reverse	0	-	O	O	O	
06-42	Operation Direction Selection of Speed-Stage 10	0: Stop 1: Forward 2: Reverse	0	-	O	O	O	
06-43	Operation Direction Selection of Speed-Stage 11	0: Stop 1: Forward 2: Reverse	0	-	O	O	O	
06-44	Operation Direction Selection of Speed-Stage 12	0: Stop 1: Forward 2: Reverse	0	-	O	O	O	

Group 06: Automatic Program Operation Parameters								
Code	Parameter Name	Setting Range	Default	Unit	Control mode			Attribute
					V/F	SLV	SLV2	
06-45	Operation Direction Selection of Speed-Stage 13	0: Stop 1: Forward 2: Reverse	0	-	0	0	0	
06-46	Operation Direction Selection of Speed-Stage 14	0: Stop 1: Forward 2: Reverse	0	-	0	0	0	
06-47	Operation Direction Selection of Speed-Stage 15	0: Stop 1: Forward 2: Reverse	0	-	0	0	0	

Group 07: Start /Stop Parameters								
Code	Parameter Name	Setting Range	Default	Unit	Control mode			Attribute
					V/F	SLV	SLV2	
07-00	Momentary Power Loss/Fault Restart Selection	0: Disable	0	-	0	0	0	
		1: Enable						
07-01	Fault Auto-Restart Time	0~7200	0	s	0	0	0	
07-02	Number of Fault Auto-Restart Attempts	0~10	0	-	0	0	0	
07-03	Reserved							
07-04	Direct Start at Power on	0: When the external run command is enabled, direct start at power up	1	-	0	0	0	
		1: When the external run command is enabled, unable to direct start at power-up.						
07-05	Delay of Direct Start at Power on	1.0~300.0	3.5	s	0	0	0	
07-06	DC Injection Braking	0.0~10.0	0.5	Hz	0	0	0	

Group 07: Start /Stop Parameters								
Code	Parameter Name	Setting Range	Default	Unit	Control mode			Attribute
					V/F	SLV	SLV2	
	Starting Frequency							
07-07	DC Injection Braking Current	0~100	50	%	O	O	O	
07-08	DC Injection Braking Time at Stop	0.00~100.00	0.50	s	O	O	O	
07-09	Stop Mode Selection	0: Deceleration to Stop	0	-	O	O	O	
		1: Coast to Stop						
		2: DC Braking Stop in All Fields						
		3: Coast to Stop with Timer						
07-10 ~ 07-12	Reserved							
07-13	Low Voltage Detection Level	380V: 250~600 *Note1	380	V	O	O	O	
07-14	Pre-excitation Time	0.00~10.00	2.00	s	X	O	X	
07-15	Pre-excitation Level	50~200	100	%	X	O	X	
07-16	DC Injection Braking Time at Start	0.00~100.00	0.00	s	O	O	O	
07-17	Reserved							
07-18	Minimum Base block Time	0.1~5.0	-	Sec	O	O	O	
07-19	Direction-Detection Speed Search Operating Current	0~100	50	%	O	O	O	
07-20	Speed Search Operating Current	0~100	20	%	O	O	O	
07-21	Integral Time of Speed Searching	0.1~10.0	2.0	Sec	O	O	O	
07-22	Delay Time of Speed Searching	0.0~20.0	0.2	Sec	O	O	O	
07-23	Voltage Recovery Time	0.1~5.0	2.0	Sec	O	O	O	
07-24	Direction-Detection Speed Search Selection	0: Disable	1	-	O	O	O	
		1: Enable						
07-25	Low Voltage Detection Time	0.00~1.00	0.02	Sec	O	O	O	
07-26	Start-up Mode Selection of SLV Coast to Stop	0: Start with speed search	0	-	X	O	X	
		1: Normal start						
07-27	Start Selection after Fault during SLV Mode	0: Start with speed search	0	-	X	O	X	
		1: Normal start						
07-28	Start after External Base Block	0: Start with speed search	0	-	O	O	O	
		1: Normal start						
07-29	Run Command Selection at the Action of DC Braking	0: Not Allowable to Run	0	-	O	X	X	
		1: Allowable to Run						
07-30	Low Voltage Level	0: Disable	0	-	O	O	O	

Group 07: Start /Stop Parameters								
Code	Parameter Name	Setting Range	Default	Unit	Control mode			Attribute
					V/F	SLV	SLV2	
	Selection	1: Enable						
07-31	Reserved							
07-32	Speed Search Mode Selection	0: Disable	0	-	O	O	X	
		1: Mode1: Execute a Speed Search at Power On						
		2: Execute a Speed Search each time						
07-33	Start Frequency of Speed Search Selection	0: Maximum Output Frequency of Motor	0	-	O	O	X	
		1: Frequency Command						
07-34 ~ 07-41	Reserved							
07-42	Voltage Limit Gain	0.0~50.0	0	%	X	O	X	

*07-13 lower voltage limit is 250V, when 07-30 Low Voltage Level Selection set 0 (Enable) . When 07-30 set 1 (Disable), lower voltage limit is 300V.

Group 08: Protection Parameters								
Code	Parameter Name	Setting Range	Default	Unit	Control mode			Attribute
					V/F	SLV	SLV2	
08-00	Stall Prevention Function	xxx0b: Stall prevention is enabled in acceleration.	0000b	-	O	O	O	
		xxx1b: Stall prevention is disabled in acceleration.						
		xx0xb: Stall prevention is enabled in deceleration.						
		xx1xb: Stall prevention is disabled in deceleration.						
		x0xxb: Stall prevention is enabled in operation						
		x1xxb: Stall prevention is disabled in operation						
		0xxxb: Stall prevention in operation is based on deceleration time of speed-stage 1.						
		1xxxb: Stall prevention in						

Group 08: Protection Parameters								
Code	Parameter Name	Setting Range	Default	Unit	Control mode			Attribute
					V/F	SLV	SLV2	
		operation is based on deceleration time of speed-stage 2.						
08-01	Stall Prevention Level in Acceleration	20~200	150	%	O	O	O	
08-02	Stall Prevention Level in Deceleration	380V: 660V~820V	680	V	O	O	O	
08-03	Stall Prevention Level in Operation	30~200	160	%	O	X	O	
08-04	Reserved							
08-05	Selection for Motor Overload Protection (OL1)	xxx0b: Overload Protection is disabled.	0101b	-	O	O	O	
		xxx1b: Overload Protection is enabled.						
		xx0xb: Cold Start of Motor Overload						
		xx1xb: Hot Start of Motor Overload						
		x0xxb: Standard Motor						
		x1xxb: Inverter Duty Motor						
		0xxxb: Reserved						
1xxxb: Reserved								
08-06	Start-up Mode of Overload Protection Operation (OL1)	0: Stop Output after Overload Protection	0	-	O	O	O	
		1: Continuous Operation after Overload Protection.						
08-07	Motor Overload (OL1) Protection Level	0: Motor Overload (OL1) Protection 0	0	-	O	O	O	
		1: Motor Overload (OL1) Protection 1						
		2: Motor Overload (OL1) Protection 2						
08-08	Automatic Voltage Regulation (AVR)	0: Enable	0	-	O	O	O	
		1: Disable						
08-09	Selection of Input Phase Loss Protection	0: Disable	0	-	O	O	O	
		1: Enable						
08-10	Selection of Output Phase Loss Protection	0: Disable	0	-	O	O	O	
		1: Enable						
08-11 08-12	Reserved							
08-13	Selection of Over-Torque Detection	0: Over-Torque Detection is Disabled.	0	-	O	O	O	
		1: Start to Detect when						

Group 08: Protection Parameters								
Code	Parameter Name	Setting Range	Default	Unit	Control mode			Attribute
					V/F	SLV	SLV2	
		Reaching the Set Frequency.						
		2: Start to Detect when the Operation is Begun.						
08-14	Selection of Over-Torque Operation	0: Deceleration to Stop when Over Torque is Detected.	0	-	O	O	O	
		1: Display Warning when Over Torque is Detected. Go on Operation.						
		2: Coast to Stop when Over Torque is Detected						
08-15	Level of Over-Torque Detection	0~300	150	%	O	O	O	
08-16	Time of Over-Torque Detection	0.0~10.0	0.1	Sec	O	O	O	
08-17	Selection of Low-Torque Detection	0: Low-Torque Detection is Disabled.	0	-	O	O	O	
		1: Start to Detect when Reaching the Set Frequency.						
		2: Start to Detect when the Operation is Begun.						
08-18	Selection of Low-Torque Operation	0: Deceleration to Stop when Low Torque is Detected.	0	-	O	O	O	
		1: Display Warning when Low Torque is Detected. Go on Operation.						
		2: Coast to Stop when Low Torque is Detected						
08-19	Level of Low-Torque Detection	0~300	30	%	O	O	O	
08-20	Time of Low-Torque Detection	0.0~10.0	0.1	Sec	O	O	O	
08-21	Limit of Stall Prevention in Acc over Base Speed	1~100	50	%	O	O	O	
08-22	Stall Prevention Detection Time in Operation	2~100	100	ms	O	O	O	
08-23	Ground Fault (GF) Selection	0: Disable	0	-	O	O	O	
		1: Enable						
08-24	External Fault Operation Selection	0: Deceleration to Stop	0	-	O	O	O	
		1: Coast to Stop						
		2: Continuous Operation						
08-25	Detection Selection of External Fault	0: Immediately Detect when the Power is Supplied.	0	-	O	O	O	
		1: Start to Detect when the Operation is Started.						
08-26 ~ 08-29	Reserved							

Group 08: Protection Parameters								
Code	Parameter Name	Setting Range	Default	Unit	Control mode			Attribute
					V/F	SLV	SLV2	
08-30	Run Permissive Function Selection	0: Deceleration to Stop	0	-	○	○	○	
		1: Coast to Stop						
08-31 ~ 08-34	Reserved							
08-35	Motor Overheating Fault Selection	0: Disable	0	-	○	○	○	
		1: Deceleration to Stop						
		2: Free Run to top						
		3: Continue Running						
08-36	PTC Input Filter Time Constant	0.00 ~ 5.00	2.00	Sec	○	○	○	
08-37	Fan Control Function	0: Start in operation	0		○	○	○	
		1: Permanent Start						
		2: Start in high temperature						
08-38	Delay Time of Fan Off	0~600	60	s	○	○	○	
08-39	Delay Time of Motor Overheat Protection	1~300	60	sec	○	○	○	
08-40	Motor2 Acceleration Stall Prevention Level	20~200	150	%	○	○	○	
08-41	Motor2 Acceleration Stall Prevention Limit	1~100	50	%	○	○	○	
08-42	PTC Protection Level	0.1~10.0V	0.7	V	○	○	○	
08-43	PTC Restart Level	0.1~10.0V	0.3	V	○	○	○	
08-44	PTC Warning Level	0.1~10.0V	0.5	V	○	○	○	

Group 09: Communication Parameters								
Code	Parameter Name	Setting Range	Default	Unit	Control mode			Attribute
					V/F	SLV	SLV2	
09-00	INV Communication Station Address	1~31	1	-	0	0	0	*3
09-01	Communication Mode Selection	0: MODBUS	0		0	0	0	*3 *5
		1: Reserved						
		2: Reserved						
		3: Reserved						
		4: Reserved						
09-02	Baud Rate Setting (bps)	0: 1200	4	-	0	0	0	*3
		1: 2400						
		2: 4800						
		3: 9600						
		4: 19200						
		5: 38400						
09-03	Stop Bit Selection	0: 1 Stop Bit	0	-	0	0	0	*3
		1: 2 Stop Bit						
09-04	Parity Selection	0: No Parity	0	-	0	0	0	*3
		1: Even Bit						
		2: Odd Bit						
09-05	Communication Data Bit Selection	0: 8 Bit Data	0	-	0	0	0	*3
		1: 7 Bit Data						
09-06	Communication Error Detection Time	0.0~25.5	0.0	S	0	0	0	*3
09-07	Fault Stop Selection	0: Deceleration to Stop Based on Deceleration Time 1 when Communication Fault Occurs.	3	-	0	0	0	*3
		1: Coast to Stop when Communication Fault Occurs.						
		2: Deceleration to Stop Based on Deceleration Time 2 when Communication Fault Occurs.						
		3: Keep Operating when Communication Fault Occurs.						
09-08	Comm. Fault Tolerance Count	1~20	1	-	0	0	0	*3
09-09	Waiting Time	5~65	5	ms	0	0	0	*3

*3: Parameter 09 does not be influenced by 13-08 (Restore Factory Setting)

Group 10: PID Parameters								
Code	Parameter Name	Setting Range	Default	Unit	Control mode			Attribute
					V/F	SLV	SLV2	
10-00	PID Target Value Source Setting	1: AI1 given	4	-	0	0	0	
		2: AI2 given						
		3: PI given						
		4:10-02 given						
		5: Reserved						
		6: Frequency Command (00-05)						
10-01	PID Feedback Value Source Setting	1: AI1 given	2	-	0	0	0	
		2: AI2 given						
		3: PI given						
10-02	PID Target Value	0.00~100.00	0.00	%	0	0	0	*1
10-03	PID Control Mode	xxx0b: PID Disable	0000b	-	0	0	0	
		xxx1b: PID Enable						
		xx0xb: PID Positive Characteristic						
		xx1xb: PID Negative Characteristic						
		x0xxb: PID Error Value of D Control						
		x1xxb: PID Feedback Value of D Ctrl						
		0xxxb: PID Output						
		1xxxb: PID Output + Frequency Command						
10-04	Feedback Gain	0.01~10.00	1.00	-	0	0	0	*1
10-05	Proportional Gain (P)	0.00~10.00	1.00	-	0	0	0	*1
10-06	Integral Time (I)	0.00~100.00	1.00	s	0	0	0	*1
10-07	Differential Time (D)	0.00~10.00	0.00	s	0	0	0	*1
10-08	AI1 Frequency Limit	0.00~599.00	0	Hz	0	0	0	
10-09	PID Bias	-100.0~100.0	0	%	0	0	0	*1
10-10	PID Output Delay Time	0.00~10.00	0.00	s	0	0	0	*1
10-11	PID Feedback Loss Detection Selection	0: Disable	0	-	0	0	0	
		1: Warning						
		2: Fault						
10-12	PID Feedback Loss Det. Lev.	0~100	0	%	0	0	0	
10-13	PID Feedback Loss Det. Time	0.0~10.0	1.0	s	0	0	0	
10-14	PID Integral Limit	0.0~100.0	100.0	%	0	0	0	*1
10-15	PID Trim Mode	0~2	0	-	0	0	0	
10-16	PID Trim Scale	0~100	0	%	0	0	0	
10-17	*Start Frequency of PID Sleep	0.00~599.00	0.00	Hz	0	0	0	
10-18	Delay Time of PID Sleep	0.0~255.5	0.0	s	0	0	0	
10-19	*Frequency of PID	0.00~599.00	0.00	Hz	0	0	0	

Group 10: PID Parameters								
Code	Parameter Name	Setting Range	Default	Unit	Control mode			Attribute
					V/F	SLV	SLV2	
	Waking up							
10-20	Delay Time of PID Waking up	0.0~255.5	0.0	s	0	0	0	
10-21 ~ 10-22	Reserved							
10-23	PID Output Limit	0.00~100.0	100.0	%	0	0	0	*1
10-24	PID Output Gain	0.0~25.0	1.0	-	0	0	0	
10-25	PID Reversal Output Selection	0: No Allowing Reversal Output	0	-	0	0	0	
		1: Allow Reversal Output						
10-26	PID Target Acceleration/Deceleration Time	0.0~25.5	0.0	s	0	0	0	
10-27	PID Feedback Display Bias	0~9999	0	-	0	0	0	
10-28	Reserved							
10-29	PID Sleep Selection	0: Disable	1	-	0	0	0	
		1: Enable						
		2: set by DI						
10-30	Upper Limit of PID Target	0.0 ~ 100.0	100.0	%	0	0	0	
10-31	Lower Limit of PID Target	0.0 ~ 100.0	0.0	%	0	0	0	
10-32	Reserved							
10-33	Maximum Value of PID Feedback	1 ~ 10000	999	-	0	0	0	
10-34	PID Decimal Width	0 ~ 4	1		0	0	0	
10-35	Reserved							
10-36	Proportional Gain 2 (P)	0.00~10.00	3.00	-	0	0	0	
10-37	Integral Time 2 (I)	0.00~100.00	0.50	Sec	0	0	0	
10-38	Differential Time 2 (D)	0.00~10.00	0.00	Sec	0	0	0	
10-39	Output Frequency Setting of PID Disconnection	00.00~599.00	30.00	Hz	0	0	0	
10-40	Selection of PID Sleep Compensation Frequency	0: Disable	0		0	0	0	
		1: Enable						
10-41	PID Mode Switch	0: General PID	0	-	0	0	0	
		1: D Type PID						

Group 11: Auxiliary Parameters								
Code	Parameter Name	Setting Range	Default	Unit	Control mode			Attribute
					V/F	SLV	SLV2	
11-00	Direction Lock Selection	0: Allow Forward and Reverse Rotation	0	-	O	O	O	
		1: Only Allow Forward Rotation						
		2: Only Allow Reverse Rotation						
11-01	Carrier frequency	0: Carrier Output Frequency Tuning 1~16: 1~16KHz Mini carrier frequency tuning: V/F,SLV2 Mini carrier frequency tuning 1k SLV Mini carrier frequency tuning 4k	* Note 1	-	O	O	O	*1
11-02	Soft PWM Function Selection	0: Disable	0	-	O	O	O	
		1: Soft PWM 1 enables						
		2: Soft PWM 2 enables						
11-03	Automatic carrier lowering selection	0: Disable	0	-	O	X	O	
		1: Enable						
11-04	S-curve Time Setting at the Start of Acceleration	0.00~2.50	0.20	s	O	O	O	
11-05	S-curve Time Setting at the Stop of Acceleration	0.00~2.50	0.20	s	O	O	O	
11-06	S-curve Time Setting at the Start of Deceleration	0.00~2.50	0.20	s	O	O	O	
11-07	S-curve Time Setting at the Stop of Deceleration	0.00~2.50	0.20	s	O	O	O	
11-08	Jump Frequency 1	0.0~599.0	0.0	Hz	O	O	O	
11-09	Jump Frequency 2	0.0~599.0	0.0	Hz	O	O	O	
11-10	Jump Frequency 3	0.0~599.0	0.0	Hz	O	O	O	
11-11	Jump Frequency Width	0.0~25.5	1.0	Hz	O	O	O	
11-12	Manual Energy Saving Gain	0~100	80	%	O	X	X	
11-13	Automatic Return Time	0~120	60	Sec	O	O	O	*1
11-14 ~ 11-17	Reserved							
11-18	Manual Energy Saving Frequency	0.0~599.0	0.00	Hz	O	X	X	
11-19	Automatic Energy Saving Function	0: Automatic energy saving is disabled.	0	-	O	X	X	
		1: Automatic energy saving is enabled.						
11-20	Filter Time of Automatic Energy Saving	0~200	140	ms	O	X	X	
11-21	Voltage Upper Limit of Energy Saving Tuning	0~100	100	%	O	X	X	

Group 11: Auxiliary Parameters								
Code	Parameter Name	Setting Range	Default	Unit	Control mode			Attribute
					V/F	SLV	SLV2	
11-22	Adjustment Time of Automatic Energy Saving	0~5000	20	ms	O	X	X	*1
11-23	Detection Level of Automatic Energy Saving	0~100	10	%	O	X	X	
11-24	Coefficient of Automatic Energy Saving	0.00~655.35	-	-	O	X	X	
11-25 ~ 11-27	Reserved							
11-28	Frequency Gain of Over Voltage Prevention 2	1~200	100	%	O	X	X	
11-29	Auto De-rating Selection	0: Disable	0	-	O	X	O	
		1: Enable						
11-30	Variable Carrier Frequency Max. Limit	2~16	-	KHz	O	X	O	
11-31	Variable Carrier Frequency Min. Limit	1~16	-	KHz	O	X	O	
11-32	Variable Carrier Frequency Proportional Gain	00~99	00	-	O	X	O	
11-33	DC Voltage Filter Rise Amount	0.1~10.0	0.1	Vdc	O	X	X	*1
11-34	DC Voltage Filter Fall Amount	0.1~10.0	5.0	Vdc	O	X	X	*1
11-35	DC Voltage Filter Dead band Level	0.0~99.0	10.0	Vdc	O	X	X	*1
11-36	Frequency Gain of OV Prevention	0.000~1.000	0.050	-	O	X	X	*1
11-37	**Frequency Limit of OV Prevention	0.00~599.00	5.00	Hz	O	X	X	
11-38	Deceleration Start Voltage of OV Prevention	380V: 400~800V	700	V	O	X	X	
11-39	Deceleration Stop Voltage of OV Prevention	380V: 600~800V	750	V	O	X	X	
11-40	OV Prevention Selection	0: Disable	0	-	O	X	X	
		1: OV Prevention Mode 1						
		2: OV Prevention Mode 2						
		3: OV Prevention Mode 3						
11-41	Selection of Reference Frequency Disappearance Detection	0: Decelerate to Stop when Reference Frequency Disappears	0	-	O	O	O	
		1: Operation is set by Parameter 11-42 when Reference Frequency Disappears						
11-42	Disappearance Level of Reference	0.0~100.0	80.0	%	O	O	O	

Group 11: Auxiliary Parameters								
Code	Parameter Name	Setting Range	Default	Unit	Control mode			Attribute
					V/F	SLV	SLV2	
	Frequency							
11-43	Hold Frequency at Start	0.0~599.0	0.0	Hz	O	O	O	
11-44	Frequency Hold Time at Start	0.0~10.0	0.0	s	O	O	O	
11-45	Hold Frequency at Stop	0.0~599.0	0.0	Hz	O	O	O	
11-46	Frequency Hold Time at Stop	0.0~10.0	0.0	s	O	O	O	
11-47	KEB Deceleration Time	0.0~25.5	0.0	s	O	X	O	*1
11-48	KEB Detection Level	400V: 380~420	400	V	O	X	O	
11-49	Reserved							
11-50	Reserved							
11-51	Braking Selection of Zero Speed	0: Disable 1: Enable	0	-	O	X	O	
11-52	Reserved							
11-53	Reserved							
11-54	Initialization of Cumulative Energy	0: Do not Clear Cumulative Energy 1: Clear Cumulative Energy	0	-	O	O	O	*1
11-55	STOP Key Selection	0: Stop Key is Disabled when the Operation Command is not Provided by Operator. 1: Stop Key is Enabled when the Operation Command is not Provided by Operator.	1	-	O	O	O	
11-56	UP/DOWN Selection	0: When UP/DOWN in Keypad is Disabled, it will be Enabled if Pressing ENTER after Frequency Modification. 1: When UP/DOWN in Keypad is Enabled, it will be Enabled upon Frequency Modification.	0	-	O	O	O	
11-57	Reserved							
11-58	Record Reference Frequency	0: Disable 1: Enable	0	-	O	O	O	*1
11-59	Gain of Preventing Oscillation	0.00~2.50	*		O	X	O	
11-60	Upper Limit of Preventing Oscillation	0~100	*	%	O	X	O	
11-61	Time Parameter of Preventing Oscillation	0~100	0		O	X	O	
11-62	Selection of Preventing Oscillation	0: Mode1 1: Mode2	1		O	X	O	

Group 11: Auxiliary Parameters								
Code	Parameter Name	Setting Range	Default	Unit	Control mode			Attribute
					V/F	SLV	SLV2	
		2: Mode3						
11-63	Strong Magnetic Selection	0: Disable 1: Enable	1		X	O	X	
11-64	Acceleration Speed Gain Adjustment	0.1~10.0	1.0	-	O	X	O	
11-65	Target Main Circuit Voltage	380V: 400V~800V	740	-	O	X	O	
11-66	2 Phase/ 3 Phase PWM Switch Frequency	6.00~60.00	20	Hz	X	O	O	
11-67	Soft PWM 2 Frequency Range	0~12000	0	Hz	X	O	X	
11-68	Soft PWM 2 Switch Frequency	6.00~60.00	20	Hz	X	O	X	
11-69	Gain of Preventing Oscillation 3	0.00~200.00	5.00	%	O	X	X	
11-70	Upper Limit of Preventing Oscillation 3	0.01~100.00	5.00	%	O	X	X	
11-71	Time Parameter of Preventing Oscillation 3	0~30000	100	ms	O	X	X	
11-72	Gain of Preventing Oscillation for switch frequency 1	0.01~300.00	30.00	Hz	O	X	X	
11-73	Gain of Preventing Oscillation for switch frequency 2	0.01~300.00	50.00	Hz	O	X	X	

***Note 1: Refer to the attachment 1. Page 4-55. The parameter of 11-01 can be changed during run operation, the range is 1~16KHz.**

Group 12: Monitoring Parameters								
Code	Parameter Name	Setting Range	Default	Unit	Control mode			Attribute
					V/F	SLV	SLV2	
12-00	Display Screen Selection (LED)	00000~77777 From the leftmost bit, it displays the screen when press DSP key in order. 0:no display 1: Output Current 2: Output Voltage 3: DC Bus Voltage 4: Heatsink Temperature 5: PID Feedback 6: AI1 Value 7: AI2 Value	00000	-	0	0	0	*1 *6
12-01	PID Feedback Display Mode (LED)	0: Display the Feedback Value by Integer (xxx)	0		0	0	0	*6
		1: Display the Feedback Value by the Value with One Decimal Place (xx.x)						
		2: Display the Feedback Value by the Value with Two Decimal Places (x.xx)						
12-02	PID Feedback Display Unit Setting (LED)	0: xxxxx (no unit)	0		0	0	0	*6
		1: xxxPb (pressure)						
		2: xxxFL (flow)						
12-03	Line Speed Display (LED)	0~60000	1500/ 1800	RPM	0	0	0	*6
12-04	Modes of Line Speed Display (LED)	0: Display Inverter Output Frequency	0	-	0	0	0	*1 *6
		1: Display Line Speed with integer (xxxxx)						
		2: Display Line Speed with the First Decimal Place (xxxx.x)						
		3: Display Line Speed with the Second Decimal Place (xxx.xx)						
		4: Display Line Speed with the Third Decimal Place (xx.xxx)						

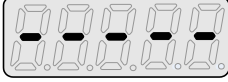
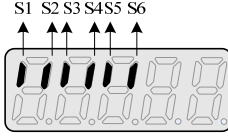
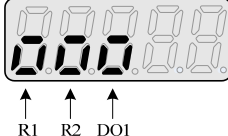
Group 12: Monitoring Parameters									
Code	Parameter Name	Setting Range	Default	Unit	Control mode			Attribute	
					V/F	SLV	SLV2		
12-05	Status Display of Digital Input & Output Terminal (LED / LCD)	<p>LED display is shown as below no input</p>  <p>correspondences to input and output</p> <p>S1 S2 S3 S4 S5 S6</p>  <p>R1 R2 DO1</p> 	-				0	0	0
12-06 ~ 12-10	Reserved								
12-11	Output Current of Current Fault	Display the output current of current fault	-	A	0	0	0		
12-12	Output Voltage of Current Fault	Display the output voltage of current fault	-	V	0	0	0		
12-13	Output Frequency of Current Fault	Display the output frequency of current fault	-	Hz	0	0	0		
12-14	DC Voltage of Current Fault	Display the DC voltage of current fault	-	V	0	0	0		
12-15	Frequency Command of Current Fault	Display the frequency command of current fault	-	Hz	0	0	0		
12-16	Frequency Command	If LED enters this parameter, it only allows monitoring frequency command.	-	Hz	0	0	0		
12-17	Output Frequency	Display the current output frequency	-	Hz	0	0	0		
12-18	Output Current	Display the current output current	-	A	0	0	0		
12-19	Output Voltage	Display the current output voltage	-	V	0	0	0		
12-20	DC Voltage (Vdc)	Display the current DC voltage	-	V	0	0	0		
12-21	Output Power (kw)	Display the current output power	-	kW	0	0	0		
12-22	Motor's Rotation Speed (rpm)	Display motor's current rotation speed in VF/SLV mode Motor's rotation speed =	-	rpm	0	0	0		

Group 12: Monitoring Parameters								
Code	Parameter Name	Setting Range	Default	Unit	Control mode			Attribute
					V/F	SLV	SLV2	
		output frequency x(120/motor's pole number) Max limit is 65535						
12-23	Output Power Factor (Pfo)	Display the current output power factor	-	-	O	O	O	
12-24	Control Mode	Display control mode 0: VF 2: SLV 6: SLV2	-	-	O	O	O	
12-25	AI1 Input	Display the current AI1 input (-10V corresponds to -100%, 10V corresponds to 100%,)	-	%	O	O	O	
12-26	AI2 Input	Display the current AI2 input (0V or 4mA corresponds to 0%, 10V or 20mA corresponds to 100%)	-	%	O	O	O	
12-27	Motor Torque	Display the current torque command (100% corresponds to motor torque)	-	%	X	O	X	
12-28	Motor Torque Current (Iq)	Display the current q-axis current	-	%	X	O	X	
12-29	Motor Excitation Current (Id)	Display the current d-axis current	-	%	X	O	X	
12-30 ~ 12-35	Reserved							
12-36	PID Input	Display input error of the PID controller (PID target value - PID feedback) (100% corresponds to the maximum frequency set by 01-02 or 01-16)	-	%	O	O	O	
12-37	PID Output	Display output of the PID controller (100% corresponds to the maximum frequency set by 01-02 or 01-16)	-	%	O	O	O	
12-38	PID Setting	Display the target value of the PID controller (100% corresponds to the maximum frequency set by 01-02 or 01-16)	-	%	O	O	O	
12-39	PID Feedback	Display the feedback value of the PID controller (100% corresponds to the maximum frequency set by 01-02 or 01-16)	-	%	O	O	O	

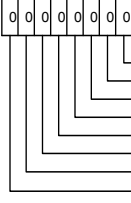
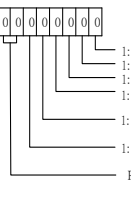
Group 12: Monitoring Parameters								
Code	Parameter Name	Setting Range	Default	Unit	Control mode			Attribute
					V/F	SLV	SLV2	
12-40	Reserved							
12-41	Heatsink Temperature*	Display the heatsink temperature of IGBT temperature**	*	°C	0	0	0	
12-42	RS-485 Error Code	 <ul style="list-style-type: none"> 1: CRC Error 1: Data length Error 1: Data Function Error 1: Parity Error 1: Overrun Error 1: Framing Error 1: Time out Error Reserved 	-	-	0	0	0	
12-43	Inverter Status	 <ul style="list-style-type: none"> 1: Inverter ready 1: During running 1: During zero speed 1: During speed agree 1: During fault detection (minor fault) 1: During fault detection (major fault) Reserved 	-	-	0	0	0	
12-44	Pulse Input Frequency	Display the frequency value of pulse input	-	Hz	0	0	0	
12-45	Recent Fault Message	Display current fault message	-	-	0	0	0	
12-46	Previous Fault Message	Display previous fault message	-	-	0	0	0	
12-47	Previous Two Fault Messages	Display previous two fault messages	-	-	0	0	0	
12-48	Previous Three Fault Messages	Display previous three fault messages	-	-	0	0	0	
12-49	Previous Four Fault Messages	Display previous four fault messages	-	-	0	0	0	
12-50	DIO Status of Current Fault	Display the DI/DO status of current fault Description is similar to 12-05	-	-	0	0	0	
12-51	Inverter Status of Current Fault	Display the inverter status of current fault Description is similar to 12-43	-	-	0	0	0	
12-52	Trip Time 1 of Current Fault	Display the operation time of current fault, 12-53 is the days, while 12-52 is the remaining hours.	-	Hr	0	0	0	
12-53	Trip Time 2 of Current Fault		-	day	0	0	0	
12-54	Frequency Command of Previous Fault	Display frequency command of previous fault	-	Hz	0	0	0	
12-55	Output Frequency of Previous Fault	Display output frequency of previous fault	-	Hz	0	0	0	
12-56	Output Current of Previous Fault	Display output current of previous fault	-	A	0	0	0	
12-57	Output Voltage of	Display output voltage of	-	V	0	0	0	

Group 12: Monitoring Parameters								
Code	Parameter Name	Setting Range	Default	Unit	Control mode			Attribute
					V/F	SLV	SLV2	
	Previous Fault	previous fault						
12-58	DC Voltage of Previous Fault	Display DC voltage of previous fault	-	V	O	O	O	
12-59	DIO Status of Previous Fault	Display DI/DO status of previous fault Description is similar to 12-05	-	-	O	O	O	
12-60	Inverter Status of Previous Fault	Display inverter status of previous fault Description is similar to 12-43	-	-	O	O	O	
12-61	Trip Time 1 of Last Fault	Display the operation time of last time's fault, 12-62 is the days, while 12-61 is the remaining hours.	-	Hr	O	O	O	
12-62	Trip Time 2 of Last Fault		-	day	O	O	O	
12-63	Recent Warning Messages	Display the recent warning messages	-	-	O	O	O	
12-64	Previous Warning Message	Display the previous warning message	-	-	O	O	O	
12-65 ~ 12-66	Reserved							
12-67	Cumulative Energy (KWHr)	0.0 ~ 999.9		kWHr	O	O	O	
12-68	Cumulative Energy (MWHr)	0 ~ 60000		MWHr	O	O	O	
12-69 ~ 12-75	Reserved							
12-76	No-Load Voltage Output	0.0~600.0	-	V	X	O	X	
12-77 ~ 12-78	Reserved							
12-79	Pulse Input Percentage	0.0~100.0	-	%	O	O	O	
12-80	All Frequency Command	0.0~599.0	0	Hz	O	O	O	

Group 13: Maintenance Parameters								
Code	Parameter Name	Setting Range	Default	Unit	Control mode			Attribute
					V/F	SLV	SLV2	
13-00	Inverter Capacity Selection	----	-	-	0	0	0	*4
13-01	Software Version	0.00-9.99	-	-	0	0	0	*4
13-02	Clear Cumulative Operation Hours	0: Disable to Clear Cumulative Operation Hours	0	-	0	0	0	*1
		1: Clear Cumulative Operation Hours						
13-03	Cumulative Operation Hours 1	0~23	-	hr	0	0	0	*4
13-04	Cumulative Operation Hours 2	0~65535	-	day	0	0	0	*4
13-05	Selection of Cumulative Operation Time	0: Cumulative time in power on	0	-	0	0	0	*1
		1: Cumulative time in operation						
13-06	Parameters Locked	0: Parameters are read-only except 13-06 and main frequency	2	-	0	0	0	*1
		1: User defined parameters						
		2: All Parameters are Writable						
13-07	Parameter Password Function	00000~65535	00000	-	0	0	0	
13-08	Restore Factory Setting	0: No initialization	-	-	0	0	0	
		2: 2 wire initialization (60Hz) (440V)						
		3: 3 wire initialization (60Hz)(440V)						
		4: Reserved						
		5: Reserved						
		6: 2 wire initialization (50Hz)(380V)						
		7: 3 wire initialization (50HZ)(380V)						
13-09	Fault History Clearance Function	0: No Clearing Fault History	0	-	0	0	0	*1
		1: Clear Fault History						
13-10	State Function	0 ~ 9999	0		0	0	0	
13-11	C/B CPLD Ver.	0.00~9.99	-		0	0	0	
13-12 ~ 13-13	Reserved							
13-14	Fault Storage Selections	0: Fault Messages of Auto Restart are not saved.	0		0	0	0	
		1: Fault Messages of Auto Restart are saved.						
13-15	Reserved							

Group 13: Maintenance Parameters								
Code	Parameter Name	Setting Range	Default	Unit	Control mode			Attribute
					V/F	SLV	SLV2	
13-21	Last time Fault History	Exhibit Last time Fault History	-	-	0	0	0	
13-22	Previous two Fault History	Exhibit Previous two Fault History	-	-	0	0	0	
13-23	Previous three Fault History	Exhibit Previous three Fault History	-	-	0	0	0	
13-24	Previous four Fault History	Exhibit Previous four Fault History	-	-	0	0	0	
13-25	Previous five Fault History	Exhibit Previous five Fault History	-	-	0	0	0	
13-26	Previous six Fault History	Exhibit Previous six Fault History	-	-	0	0	0	
13-27	Previous seven Fault History	Exhibit Previous seven Fault History	-	-	0	0	0	
13-28	Previous eight Fault History	Exhibit Previous eight Fault History	-	-	0	0	0	
13-29	Previous night Fault History	Exhibit Previous night Fault History	-	-	0	0	0	
13-30	Previous ten Fault History	Exhibit Previous ten Fault History	-	-	0	0	0	
13-31	Previous eleven Fault History	Exhibit Previous eleven Fault History	-	-	0	0	0	
13-32	Previous twelve Fault History	Exhibit Previous twelve Fault History	-	-	0	0	0	
13-33	Previous thirteen Fault History	Exhibit Previous thirteen Fault History	-	-	0	0	0	
13-34	Previous fourteen Fault History	Exhibit Previous fourteen Fault History	-	-	0	0	0	
13-35	Previous fifteen Fault History	Exhibit Previous fifteen Fault History	-	-	0	0	0	
13-36	Previous sixteen Fault History	Exhibit Previous sixteen Fault History	-	-	0	0	0	
13-37	Previous seventeen Fault History	Exhibit Previous seventeen Fault History	-	-	0	0	0	
13-38	Previous eighteen Fault History	Exhibit Previous eighteen Fault History	-	-	0	0	0	
13-39	Previous nineteen Fault History	Exhibit Previous nineteen Fault History	-	-	0	0	0	
13-40	Previous twenty Fault History	Exhibit Previous twenty Fault History	-	-	0	0	0	
13-41	Previous twenty one Fault History	Exhibit Previous twenty one Fault History	-	-	0	0	0	
13-42	Previous twenty two Fault History	Exhibit Previous twenty two Fault History	-	-	0	0	0	
13-43	Previous twenty	Exhibit Previous twenty	-	-	0	0	0	

Group 13: Maintenance Parameters								
Code	Parameter Name	Setting Range	Default	Unit	Control mode			Attribute
					V/F	SLV	SLV2	
	three Fault History	three Fault History						
13-44	Previous twenty four Fault History	Exhibit Previous twenty four Fault History	-	-	0	0	0	
13-45	Previous twenty five Fault History	Exhibit Previous twenty five Fault History	-	-	0	0	0	
13-46	Previous twenty six Fault History	Exhibit Previous twenty six Fault History	-	-	0	0	0	
13-47	Previous twenty seven Fault History	Exhibit Previous twenty seven Fault History	-	-	0	0	0	
13-48	Previous twenty eight Fault History	Exhibit Previous twenty eight Fault History	-	-	0	0	0	
13-49	Previous twenty nine Fault History	Exhibit Previous twenty nine Fault History	-	-	0	0	0	
13-50	Previous thirty Fault History	Exhibit Previous thirty Fault History	-	-	0	0	0	

Group 17: Automatic Tuning Parameters								
Code	Parameter Name	Setting Range	Default	Unit	Control mode			Attribute
					V/F	SLV	SLV2	
17-00	Mode Selection of Automatic Tuning*	0: Rotation Auto-tuning	VF:2 SLV:6 SLV2:6	-	0	0	0	
		1: Static Auto-tuning						
		2: Stator Resistance Measurement						
		3: Reserved						
		4: Loop Tuning						
		5: Rotation Auto-tuning Combination (item: 4+2+0)						
6: Static Auto-tuning Combination (item: 4+2+1)								
17-01	Motor Rated Output Power	0.00~600.00	KVA *Note1	KW	0	0	0	
17-02	Motor Rated Current	0.1~1200.0	KVA *Note1	A	0	0	0	
17-03	Motor Rated Voltage	380V: 100.0~480.0	380	V	0	0	0	
17-04	Motor Rated Frequency	4.8~599.0	60.0	Hz	0	0	0	
17-05	Motor Rated Speed	0~24000	KVA *Note1	rpm	0	0	0	
17-06	Pole Number of Motor	2~16 (Even)	4	Pole	0	0	0	
17-07	PG Pulse Number	0~60000	1024	ppr	X	X	X	
17-08	Motor no-load Voltage	380V: 100~480	-	V	0	0	0	

Group 17: Automatic Tuning Parameters								
Code	Parameter Name	Setting Range	Default	Unit	Control mode			Attribute
					V/F	SLV	SLV2	
17-09	Motor Excitation Current	0.01~600.00	-	A	X	O	X	*1
17-10	Automatic Tuning Start	0: Disable	0	-	O	O	O	
		1: Enable						
17-11	Error History of Automatic Tuning	0: No error	0	-	O	O	O	
		1: Motor data error						
		2: Stator resistance tuning error						
		3: Leakage induction tuning error						
		4: Rotor resistance tuning error						
		5: Mutual induction tuning error						
		6: Encoder error						
		7: DT Error						
		8: Motor's acceleration error						
9: Warning								
17-12	Proportion of Motor Leakage Inductance	0.1~15.0	3.4	%	X	O	X	
17-13	Motor Slip Frequency	0.10~20.00	1.00	Hz	X	O	X	
17-14	Selection of Rotation Auto-tuning	0:VF Rotation Auto-tuning	0	-	O	O	O	
		1: Vector Rotation Auto-tuning						

*Note1: KVA: The default value of this parameter will be changed by different capacities of inverter.

*Note: It is suggested that application presets (00-32) be selected first before motor performs auto-tuning.

Note: The value of mode selection of automatic tuning is 6 (Static Auto-tuning Combination). When do auto-tuning with no-load motor, it suggest select 17-00=5 (Rotation Auto-tuning Combination)

*1: It can be set when 17-00=1, 2, 6.

Group 18: Slip Compensation Parameters								
Code	Parameter Name	Setting Range	Default	Unit	Control mode			Attribute
					V/F	SLV	SLV2	
18-00	Slip Compensation Gain at Low Speed.	0.00~2.50	VF:0.00	-	O	O	O	*1
			SLV *Note1					
18-01	Slip Compensation Gain at High Speed.	-1.00~1.00	0.0	-	O	O	X	*1
18-02	Slip Compensation Limit	0~250	200	%	O	X	X	
18-03	Slip Compensation Filter Time	0.0~10.0	1.0	Sec	O	X	X	
18-04	Regenerative Slip Compensation Selection	0: Disable	0	-	O	X	X	
		1: Enable						
18-05	FOC Delay Time	1~1000	100	ms	X	O	X	
18-06	FOC Gain	0.00~2.00	0.1	-	X	O	X	

* Note1: Refer to the following attachment 1, Page4-55

Group 19: Wobble Frequency Parameters								
Code	Parameter Name	Setting Range	Default	Unit	Control mode			Attribute
					V/F	SLV	SLV2	
19-00	Center Frequency of Wobble Frequency	5.00~100.00	20.00	%	O	X	O	*1
19-01	Amplitude of Wobble Frequency	0.1~20.0	10.0	%	O	X	O	*1
19-02	Jump Frequency of Wobble Frequency	0.0~50.0	0.0	%	O	X	O	*1
19-03	Jump Time of Wobble Frequency	0~50	0	ms	O	X	O	*1
19-04	Wobble Frequency Cycle	0.0~1000.0	10.0	Sec	O	X	O	*1
19-05	Wobble Frequency Ratio	0.1~10.0	1.0		O	X	O	*1
19-06	Upper Offset Amplitude of Wobble Frequency	0.0~20.0	0.0	%	O	X	O	*1
19-07	Lower Offset Amplitude of Wobble Frequency	0.0~20.0	0.0	%	O	X	O	*1

Group 20: Speed Control Parameters								
Code	Parameter Name	Setting Range	Default	Unit	Control mode			Attribute
					V/F	SLV	SLV2	
20-00	ASR Gain 1	0.00~250.00	-	-	X	O	X	*1
20-01	ASR Integral Time 1	0.001~10.000	-	Sec	X	O	X	*1
20-02	ASR Gain 2	0.00~250.00	-	-	X	O	X	*1
20-03	ASR Integral Time 2	0.001~10.000	-	Sec	X	O	X	*1
20-04	ASR Integral Time Limit	0~300	200	%	X	O	X	
20-05	ASR Positive Limit	0.1 ~ 10.0	5.0	%	X	X	X	
20-06	ASR Negative Limit	0.1 ~ 10.0	1.0	%	X	X	X	
20-07	Selection of Acceleration and Deceleration of P/PI	0: PI speed control will be enabled only in constant speed. For the speed acceleration and deceleration, only use P control. 1: Speed control is enabled either in acceleration or deceleration.	0	-	X	O	X	
20-08	ASR Delay Time	0.000~0.500	0.004	Sec	X	O	X	
20-09	Speed Observer Proportional (P) Gain1	0.00~2.55	0.61	-	X	O	X	*1
20-10	Speed Observer Integral(I) Time 1	0.01~10.00	0.05	Sec	X	O	X	*1

Group 20: Speed Control Parameters								
Code	Parameter Name	Setting Range	Default	Unit	Control mode			Attribute
					V/F	SLV	SLV2	
20-11	Speed Observer Proportional (P) Gain2	0.00~2.55	0.61	-	X	O	X	*1
20-12	Speed Observer Integral(I) Time 2	0.01~10.00	0.06	Sec	X	O	X	*1
20-13	Low-pass Filter Time Constant of Speed Feedback 1	1~1000	4	ms	X	O	X	
20-14	Low-pass Filter Time Constant of Speed Feedback 2	1~1000	30	ms	X	O	X	
20-15	ASR Gain Change Frequency 1	0.0~599.0	4.0	Hz	X	O	O	
20-16	ASR Gain Change Frequency 2	0.0~599.0	8.0	Hz	X	O	O	
20-17	Torque Compensation Gain at Low Speed	0.00~2.50	1.00	-	X	O	X	*1
20-18	Torque Compensation Gain at High Speed	-10~10	0	%	X	O	X	*1
20-19 ~ 20-32	Reserved							
20-33	Detection Level at Constant Speed	0.1~5.0	1.0		X	O	X	*1
20-34	Compensation Gain of Derating	0~25600	0		X	O	X	*1
20-35	Compensation Time of Derating	0~30000	100	ms	X	O	X	*1

Group 21: Torque And Position Control Parameters								
Code	Parameter Name	Setting Range	Default	Unit	Control mode			Attribute
					V/F	SLV	SLV2	
21-00 ~ 21-04	Reserved							
21-05	Positive Torque Limit	0~300	*Note1	%	X	O	X	
21-06	Negative Torque Limit	0~300	* Note1	%	X	O	X	
21-07	Forward Regenerative Torque Limit	0~300	* Note1	%	X	O	X	
21-08	Reversal Regenerative Torque Limit	0~300	* Note1	%	X	O	X	

* Note1: Refer to the following attachment 1.

Attachment 1: Parameters' default value and upper limit value are adjusted by different capacities of inverter.

Models	Frame	Max. frequency (Hz) in SLV when carrier frequency <= 8K 11-01	Max. frequency (Hz) in SLV when carrier frequency > 8K 11-01	The initial value of parameter 18-00 in SLV/ SV (Slip compensation at low speed)
4015	3	150	150	1.00
4020		110	110	
4025	4	100	100	1.00
4030				
4040	5	100	80	0.70
4050				
4060	6	100	80	0.70
4075				
4100	7	100	80	0.70
4125				
4150	8	100	80	0.50
4175				
4215				

Models	The initial value of parameters 21-05 ~21-08 (Torque Limit)	The initial value (s) of parameter 20-08 (ASR Filter Time)	The initial value (s) of Accel. & Decel of 00-14~00-17 & 00-23~00-27	Default carrier in HD kHz 11-01	Max. carrier in HD kHz (SLV, Max. > 80Hz) 11-01	Max. carrier in HD kHz (others) 11-01
4015	160%	0.001	10.0	8	8	16
4020		0.002	15.0			
4025	160%	0.002	15.0	8	8	16
4030						
4040	150%	0.002	20.0	5	8	12
4050						
4060	150%	0.002	20.0	5	8	10
4075		0.004				
4100	150%	0.004	20.0	5	8	10
4125				4	8	10
4150	150%	0.004	20.0	5	8	10
4175				5	8	10
4215				3	8	8

*Min. Carrier frequency in SLV mode is 4kHz.

Low Voltage Detection Level Function:

Wiring:

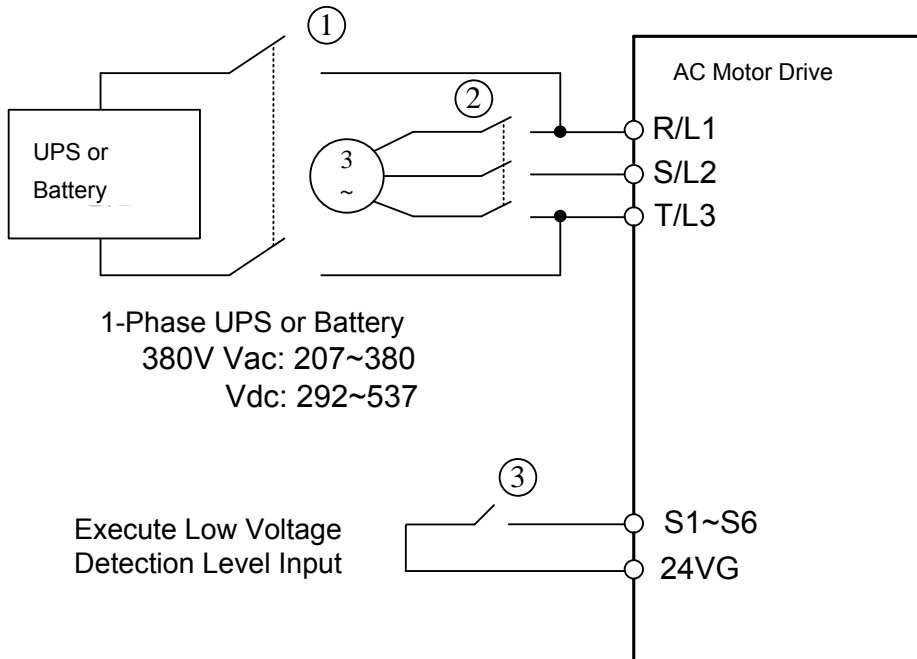

Timing Diagram of Magnetic Contactor

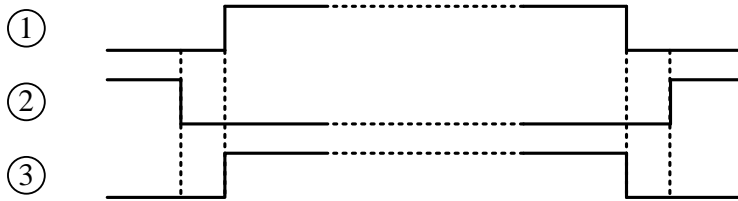

Before inputting emergency power, magnetic contactor ① and ③ are ON and magnetic contactor ② should be OFF. Magnetic contactor ③ should be ON after magnetic contactor ② is ON. Before removing battery and turning magnetic contactor ② to be ON, Magnetic contactor ① and ③ should be OFF.

Notes for the emergency power supply. Please be aware of the following condition when emergency power is ON:

1. Execute Low Voltage Function ON (DI=62) › Fan doesn't run.
2. Execute Low Voltage Function ON (DI=62) › No phase loss.
3. Execute Low Voltage Function ON (DI=62) › run frequency of motor depends on the value of 07-31

Relevant parameters:

07-13 lower voltage limit is 250V, when 07-30 Low Voltage Level Selection set 0 (Enable) .

When 07-30 set 1 (Disable), lower voltage limit is 300V.

03-00~03-05 Set EPS input (62) enable.

07-31 Set Low Voltage Run Frequency

DC injection braking at stop

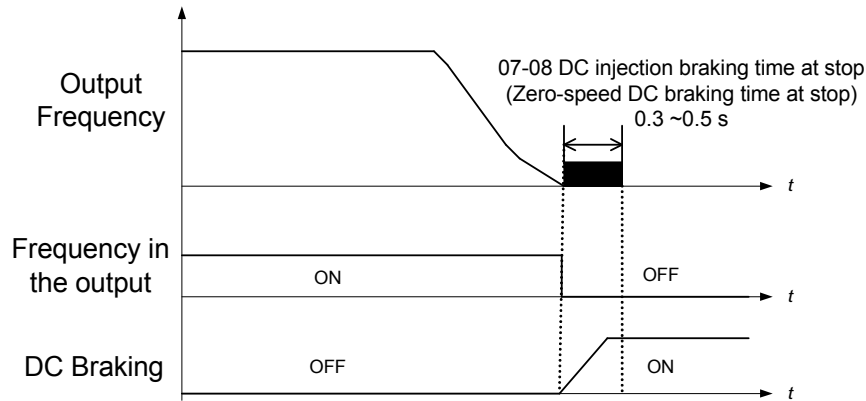

When mechanism action of braking is slow, in order to avoid dropping at stop, please stop by DC braking until the braking is fully closed.

Note 1: When motor control or DC braking (zero-speed control) is separated, sometimes the inverter is broken down due to surge voltage. In addition, output phase protection 08-10 set 1 (Enable), when the contactor is used between inverter and motor.

4.3 Description of Parameters

00-00	Control mode selection
Range	0: V/F 2: SLV 6: SLV2

The inverter offers the following control modes:

Value	Mode	Info	Application
0	V/F	V/F Control without PG	General Purpose Applications which do not require high precision speed control - Auto-tuning is not required.
2	SLV	Sensorless Vector Control without PG	General Purpose Applications that require higher precision speed control and torque response without the use of an encoder.
6	SLV2	Voltage vector control without PG	Without PG Applications. Vector control provides high speed rotation and the requirements of higher precision speed than V/F and torque.

00-00=0: V/F Mode

Select the required V/F curve (01-00) based on your motor and applications.

Perform a stationary auto-tune (17-00=2), if the motor cable is longer than 50m (165ft), see parameter 17-00 for details.

00-00=2: Sensorless Vector Control

Verify the inverter rating matches the motor rating. Perform rotational auto-tune to measure and store motor parameters for higher performance operation. Perform non-rotational auto-tune if it's not possible to rotate the motor during auto-tune. Refer to parameter group 17 for details on auto-tuning.

00-00=6: SLV2 Vector Control

Verify the inverter rating matches the motor rating. Perform rotational auto-tune to measure and store motor parameters for higher performance operation.

Refer to parameter group 17 for the descriptions of motor parameter tuning function.

Select the required V/F curve (01-00) based on your motor and applications.

Note: Parameter 00-00 is excluded from initialization.

00-01	Motor's rotation direction
Range	0: Forward 1: Reverse

Use the FWD/REV key to change motor direction when Run Command Selection (00-02 = 0) is set to keypad control.

00-02	Run command selection
Range	0: Keypad control 1: External terminal control 2: Communication control 3: Reversed

00-02=0: Keypad Control

Use the keypad to start and stop the inverter and set direction with the forward / reverse key). Refer to section 4-1 for details on the keypad.

00-02=1: External terminal control

External terminals are used to start and stop the inverter and select motor direction.

00- 03	Alternative RUN Command Selection
Range	0: Keypad control 1: External terminal control 2: Communication control 3: Reversed

00-03=0: Keypad Control

Use the keypad to start and stop the inverter and set direction with the forward / reverse key). Refer to section 4-1 for details on the keypad.

00-03=1: External terminal control

External terminals are used to start and stop the inverter and select motor direction.

***It is required to be with multi-function digital input (12: main and alternative run switch function).**

The inverter can be operated in either 2-wire or 3-wire mode.

■ 2-wire operation

For 2-wire operation, set 03-00 (S1 terminal selection) to 0 and 03-01 (S2 terminal selection) to 1.

Terminal S1	Terminal S2	Operation
Open	Open	Stop Inverter / FWD Active
Closed	Open	Run Forward
Open	Closed	Run Reverse
Closed	Closed	Stop Inverter, Display EF9 Alarm after 500ms

Parameter 13-08 to 2 or 6 for 2-wire program initialization, multi-function input terminal S1 is set to forward , operation/ stop, and S2 is set for reverse, operation / stop.

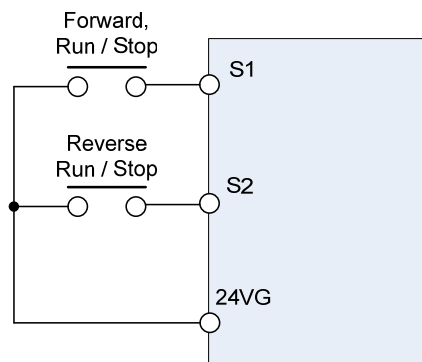

Figure 4.4.1 wiring example of 2-wire

■ 3-wire operation

For 3-wire operation set any of parameters 03-02 to 03-05 (terminal S3 ~ S6) to 26 to enable 3-wire operation in combination with S1 and S2 terminals set to run command and stop command.

Parameter 13-08 to 3 or 7 for 3-wire program initialization, multi-function input terminal S1 is set to run operation, S2 for stop operation and S6 for forward/reverse command.

Note: Terminal S1 must be closed for a minimum of 50ms to activate operation.

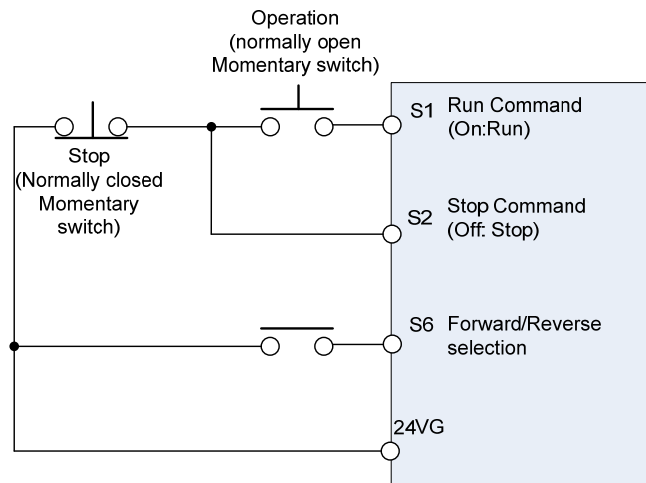

Figure 4.4.2 wiring example of 3-wire

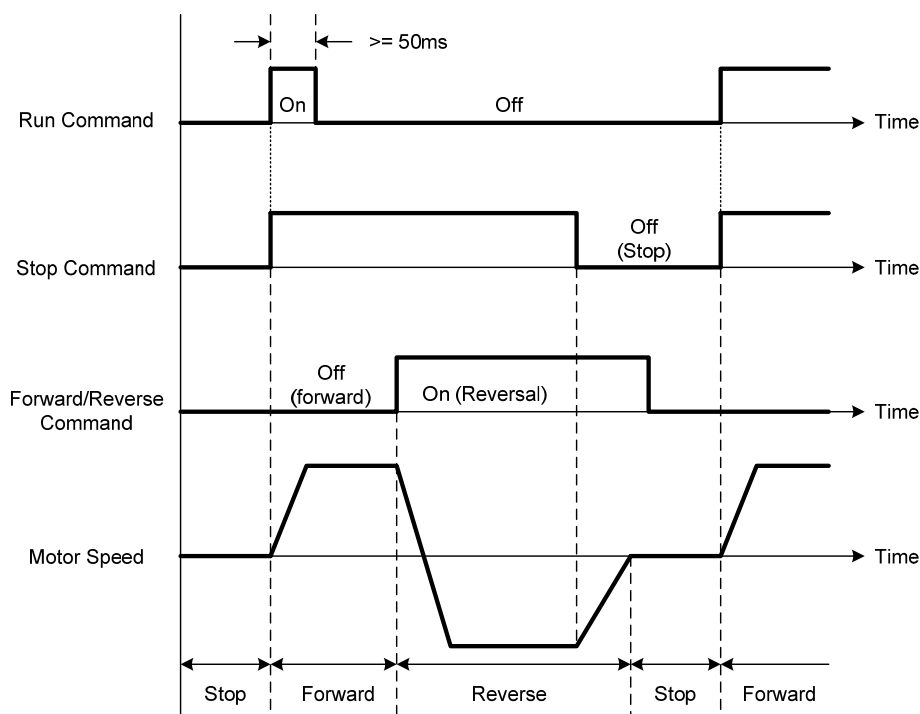
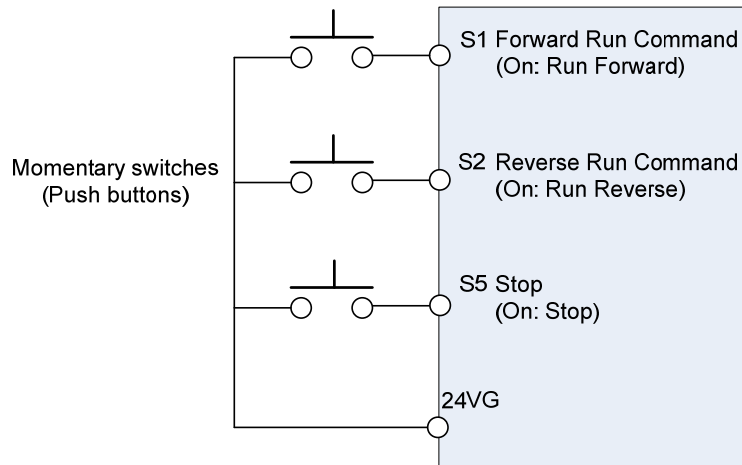

Figure 4.4.3 3-wire operation

■ 2-wire operation with hold function

To enable 2-wire operation with hold function, set any of parameters 03-00 to 03-05 (terminal S1 ~ S6) to 53. When this mode is enabled set terminal S1 (03-00=0) to forward and S2 (03-01=1) to reverse run command,

set terminal S3 (03-02=53) to 2-Wire Self Holding Mode (Stop Command)



Note: Terminal S1, S2 and S5 must be closed for a minimum of 50ms to activate operation.

Note: The inverter will display SE2 error when input terminals S1-S6 is set to 53 and 26 simultaneously.

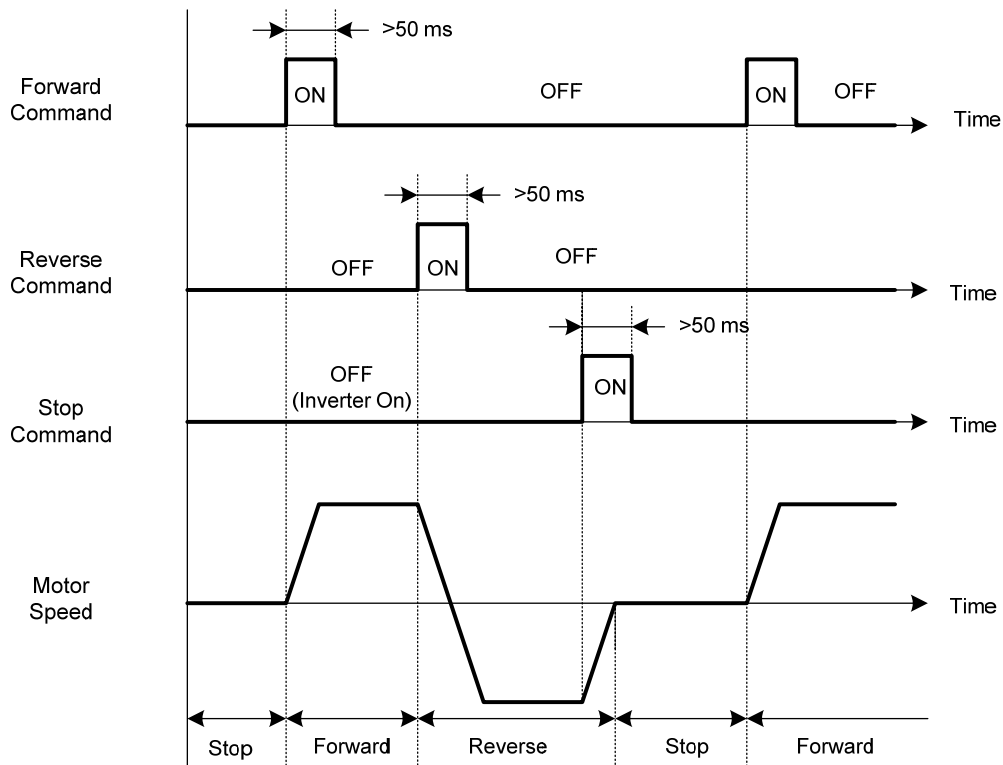

00-02=2: Communication control

The inverter is controlled by the RS-485 port. Refer to parameter group 9 for communication setup.

00-05	Main Frequency Command Source Selection
00-06	Alternative Frequency Source Selection
Range	<p>0: Keypad 1: External control (analog) 2: Terminal UP / DOWN 3: Communication control 4: Pulse input 5: Reserved 6: Reserved 7: AI2 Auxiliary Frequency 8: Potentiometer on Keypad</p>

00-05/00-06= 0: Keypad

Use the digital operator to enter frequency reference or to set parameter 05-01 (frequency reference 1) as alternative frequency reference source. Refer to section 4.1.4 for details.

00-05/00-06= 1: External control (Analog Input)

Use analog reference from analog input AI1 or AI2 to set the frequency reference (as shown in Figure 4.4.4). Refer to parameters 04-00 to select the signal type.

AI1 – Analog Input 1	AI2 – Analog Input 2	04-00 Setting (Default = 1)	Dipswitch SW2 (Default 'V')
0 ~ 10V	0 ~ 10V	0	Set to 'V'
0 ~ 10V	4 ~ 20mA	1	Set to 'I'
-10 ~ 10V	0 ~ 10V	2	Set to 'V'
-10 ~ 10V	4 ~ 20mA	3	Set to 'I'

Note: Set parameter 04-05 to 10 to add frequency reference using AI2 to AI1.

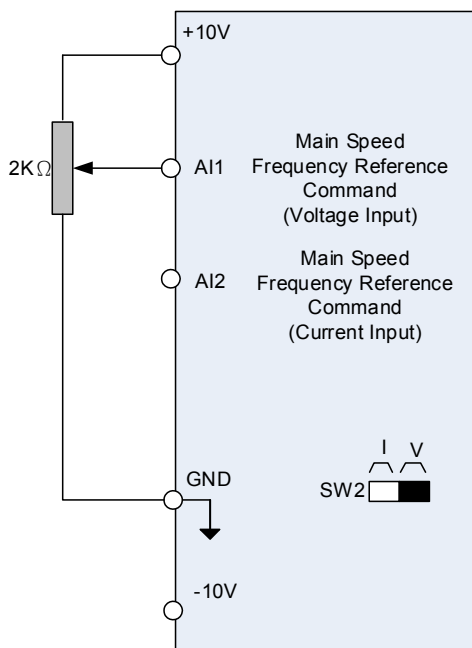

Figure 4.4.4 Analog input as main frequency reference command

00-05/00-06= 2: Terminal UP / DOWN

The inverter accelerates with the UP command closed and decelerates with the DOWN command closed. Please refer to parameter 03-00 ~ 03-05 for additional information.

Note: To use this function both the UP and DOWN command have to be selected to any of the input terminals.

00-05/00-06= 3: Communication control

The frequency reference command is set via the RS-485 communication port using the MODBUS RTU protocol.

Refer to parameter group 9 for additional information.

00-05/00-06= 4: Pulse input

To use this function a pulse train input is required to be connected to the PI input and GND (see fig. 4.4.5).

Set parameter 03-30 to 0 to use the pulse input as frequency reference. Refer to parameters 03-31 to 03-34 for pulse input scaling.

PI input terminal, built-in resistance, is not required to connect the resistance if open collector input mode is used.

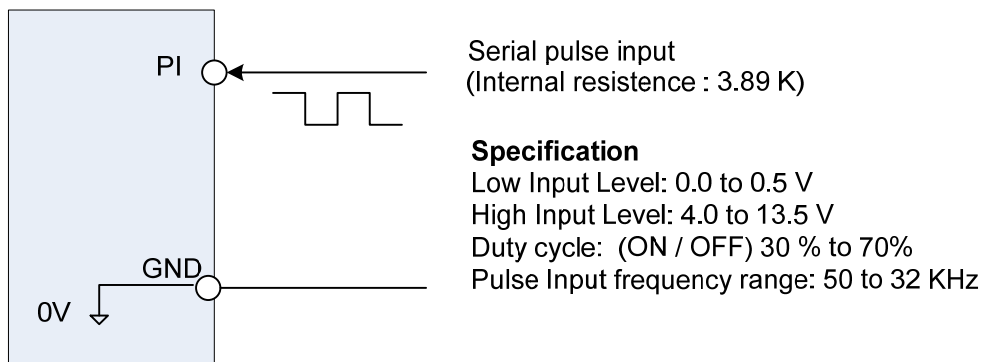

Figure 4.4.5 Frequency reference from pulse input

00-05/00-06= 7: AI2 Auxiliary Frequency

When 04-05 is set to 0 (auxiliary frequency), frequency command is provided by multi-function analog input AI2 and the maximum output frequency (01-02, Fmax) = 100%.

When 04-05 is not set to 0, the frequency is 0. Refer to p4-76 for multi-speed descriptions.

00-05/00-06= 8:

Use FREQ.SET knob on the keypad frequency command

00- 07	Main and Alternative Frequency Command modes
Range	0: Main frequency 1: Main frequency + alternative frequency

When 00-07 is set to 0, the reference frequency is set by the main reference frequency selection of parameter 00-05. When 00-07 is set to 1 the reference frequency is sum of the main reference frequency (00-05) and alternative frequency (00-06).

Note: The inverter will display the SE1 error when 00-07 = 1 and parameter 00-05 and 00-06 are set to the same selection.

When parameter 00-06 is set to 0 (Keypad) the alternative frequency reference is set by parameter 05-01 (Frequency setting of speed-stage 0).

00- 08	Communication frequency command – READ ONLY
Range	0.00~599.00 Hz

Display the frequency reference when 00-05 or 00-06 is set to communication control (3).

00-09	Communication frequency command memory
Range	0: Don't save when power supply is off. (00-08) 1: Save when power is off. (00-08)

Note: This parameter is only enabled in communication mode.

00-10	Minimum frequency detection
Range	0: Show warning if lower than minimum frequency 1: Run as minimum frequency if lower than minimum frequency

00-10=0: Frequency command is lower than 01-08 (Minimum Output Frequency of Motor 1), it shows STP0 warning.

00-10=1: Frequency command is lower than 01-08 (Minimum Output Frequency of Motor 1), inverter run as Minimum Output Frequency of Motor 1.

00- 11	Selection of PID Lower Limit Frequency
Range	【0】 : PID is bound to lower limit frequency when inverter sleeps. 【1】 : PID is bound to 0Hz when inverter sleeps.

When inverter gets to sleep,

00-11=0: PID is bound to lower limit frequency (00-13).

00-11=1: PID is bound to 0 Hz.

Note: Refer to descriptions of parameters 10-17~10-20 for details when inverter gets to sleep.

00-12	Upper Limit Frequency
Range	0.1~109.0 %

Set the maximum frequency reference as a percentage of the maximum output frequency. Maximum output frequency depends on motor selection.

Motor 1: Maximum frequency parameter 01-02.

Motor 2: Maximum frequency parameter 01-16.

00-13	Lower Limit Frequency
Range	0.0~109.0 %

Set the minimum frequency reference as a percentage of the maximum output frequency. Maximum output

frequency depends on motor selection. Motor 1: Maximum frequency is set by parameter 01-02 and Motor 2 Maximum frequency is set by parameter 01-16.

Notes:

- When the frequency lower limit is set to a value greater than 0 and the inverter is started the output frequency will accelerate to the frequency lower limit with a minimum frequency defined by parameter 01-08 for motor 1 and parameter 01-22 for motor 2.
- Frequency upper limit has to be greater or equal to the frequency lower limit otherwise the inverter will display a SE01 (Set range error).
- Frequency upper and lower limit is active for all frequency reference modes.

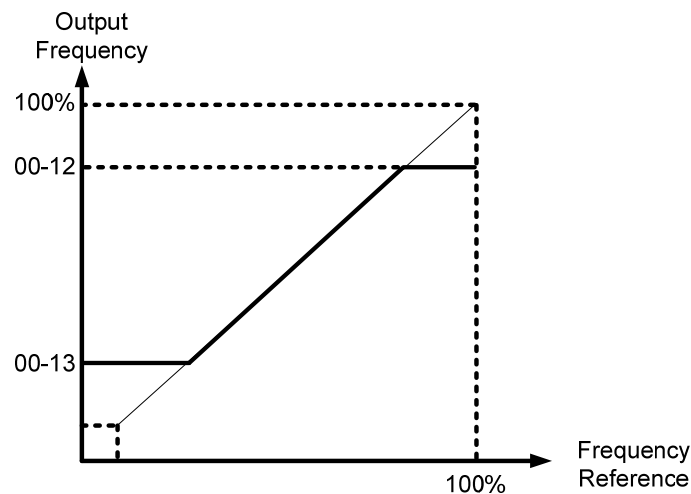

Figure 4.4.6 Frequency reference upper and lower limits

Note: The maximum frequency setting in the keypad is according to parameter 01-02 (Maximum Output Frequency) and 00-12 (Upper Frequency limit). The upper frequency limit is not over than 599Hz and AI frequency is 100% to parameter 01-02.

00-14	Acceleration time 1
Range	0.1~6000.0 Sec
00-15	Deceleration time 1
Range	0.1~6000.0 Sec
00-16	Acceleration time 2
Range	0.1~6000.0 Sec
00-17	Deceleration time 2
Range	0.1~6000.0 Sec
00-21	Acceleration time 3
Range	0.1~6000.0 Sec
00-22	Deceleration time 3
Range	0.1~6000.0 Sec
00-23	Acceleration time 4
Range	0.1~6000.0 Sec
00-24	Deceleration time 4
Range	0.1~6000.0 Sec
00-25	Switch-Over Frequency of Acceleration and Deceleration Time 1 and Time 4
Range	0.00~599.00 Hz

Acceleration time is the time required to accelerate from 0 to 100% of maximum output frequency.
 Deceleration time is the time required to decelerate from 100 to 0% of maximum output frequency.
 Motor 1: Maximum frequency is set by parameter 01-02 and Motor 2 Maximum frequency is set by parameter 01-16.

Note: Actual acceleration and deceleration times can be affected by the inverter driven load.

The default values for the acceleration, deceleration times are dependent on the inverter size.

Size	Acceleration / Deceleration
400V series	Default Value
15HP	10s
20~30HP	15s
40~215HP	20s

A: Select acceleration and deceleration time via the digital input terminals

The following table shows the acceleration / deceleration selected when the digital input function Accel/ Decel time 1 (#10) and Accel/Decel time 2 1(#30) are used.

Table 4.4.1 acceleration / deceleration time selection

Accel/decel time 2 (Set 03-00 ~ 03-05 = 30)	Accel/decel time 1 (Set 03-00 to 03-05 = 10)	Acceleration time	Deceleration time
0	0	Tacc1 (00-14)	Tdec1 (00-15)
0	1	Tacc2 (00-16)	Tdec2 (00-17)
1	0	Tacc3 (00-21)	Tdec3 (00-22)
1	1	Tacc4 (00-23)	Tdec4 (00-24)

0: OFF, 1: ON

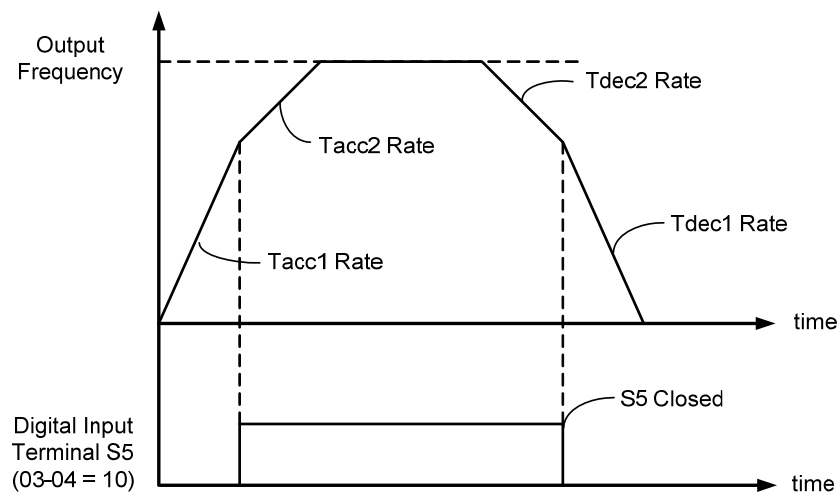

Figure 4.4.7: Terminal switch between Tacc1/Tacc2 and Tdec1/Tdec2

B. Switch of Acceleration/Deceleration time according to motors

03-00~03-05 set to 40 (Switching between motor 1/motor 2), it can switch motors by digital input. This function I only for V/F control mode.

Chose for motor1, acceleration and deceleration time of multi-speed depends on Figure 4.4.1.

Chose for motor, acceleration and deceleration time of multi-speed depends on the following Figure.

Chose motor2		
acceleration and deceleration time 1 (Set 03-00 to 03-05 = 10)	acceleration	deceleration
0	Tacc3(00-21)	Tdec3(00-22)
1	Tacc4(00-23)	Tdec4(00-24)

C. Automatically switch acceleration/deceleration time

When output frequency equals to the value of 00-25, it follows the value of 00-25 to automatically switch acceleration/ deceleration time1 and time2. Please refer to the following Figure 4.4.8.

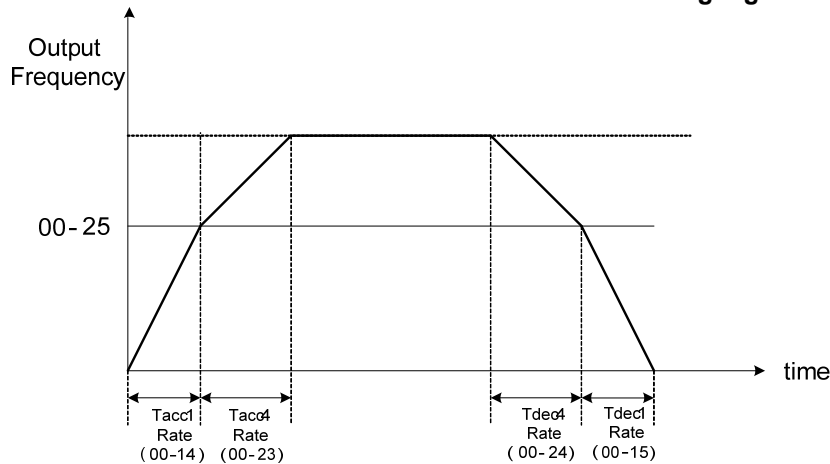

Figure 4.4.8 automatically switch Acceleration/Deceleration time

- When output frequency $F_{out} < 00-25$: **Acceleration/deceleration time = Acceleration time1/ deceleration time 1**(00-14 and 00-15).
- When output frequency $F_{out} \geq 00-25$: **Acceleration/deceleration time = Acceleration time4/ deceleration time 4**(00-23 and 00-24)

When 03-00~03-05 set to 10 (Acceleration/ Deceleration Time Selection 1) and 03-00~03-05 set to 3 (Acceleration/ Deceleration Time Selection 2), the priority is higher than 00-25.

00-18	Jog frequency
Range	0.00~599.00 Hz

00-19	Jog acceleration time
Range	0.1~6000.0 Sec

00-20	Jog deceleration time
Range	0.1~6000.0 Sec

Jog acceleration time (00-19) is the time required to accelerate from 0 to 100% of maximum output frequency. Jog deceleration time (00-20) is the time required to decelerate from 100 to 0% of maximum output frequency. Motor 1: Maximum frequency is set by parameter 01-02 and Motor 2 Maximum frequency is set by parameter 01-16.

When run command selection is external terminal control (00-02=1) and the inverter uses the jog frequency

(00-18, default 6.0 Hz) as its frequency reference with 03-00~03-05=6 or 7(6: Forward jog run command 7: Reverse jog run command).The motor will run by the setting.

00-26	Emergency stop time
Range	0.0~6000.0 Sec

The emergency stop time is used in combination with multi-function digital input function #14 (Emergency stop). When emergency stop input is activated the inverter will decelerate to a stop using the Emergency stop time (00-26) and display the [EM STOP] condition on the keypad.

Note: To cancel the emergency stop condition the run command has to be removed and emergency stop input deactivated.

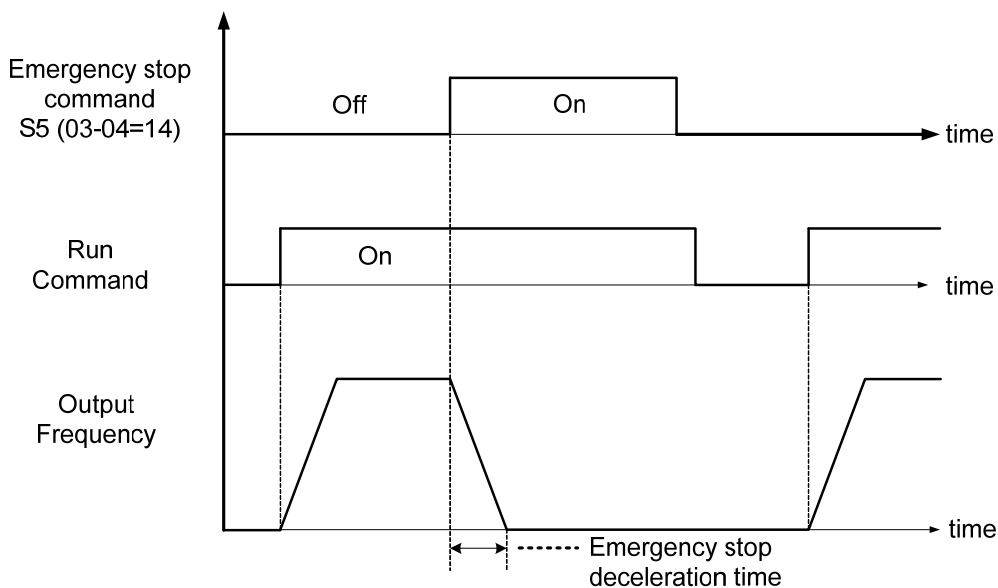

Figure 4.4.9 Emergency stop example

Multi-function digital input terminals (03-00 ~ 03-05) are set to 14: When the emergency stop input is activated the inverter will decelerate to a stop using the time set in parameter 00-26.

Note: After an emergency stop command the run command and emergency stop command have to be removed before the inverter can be restarted. Please refer to Figure 4.4.9. The emergency stop function can be used to stop inverter in case of an external event.

Multi-function digital input terminals (03-00 ~ 03-05) set to 15: When the base block input is activated the inverter output will turn off and the motor will coast to a stop.

00-28	Command characteristic selection of master frequency
Range	0: Positive characteristic (0-10V / 4-20mA = 0 -100%) 1: Negative / inverse characteristic (0-10V / 4~20mA = 100 - 0%)

00-28= 0: Positive reference curve, 0 – 10V / 4 – 20mA = 0 – 100% main frequency reference.

00-28= 1: Negative reference curve, 0 – 10V / 4 – 20mA = 100 – 0% main frequency reference.

Note 1: Selection applies to analog input AI1 and AI2.

Note 2: AI2 will be useful for analog input frequency command when 04-05=0.

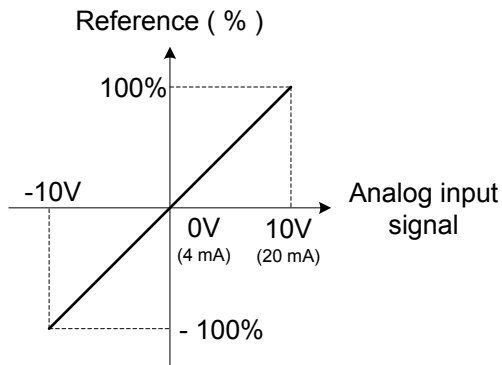

(a) Normal / Positive Characteristics

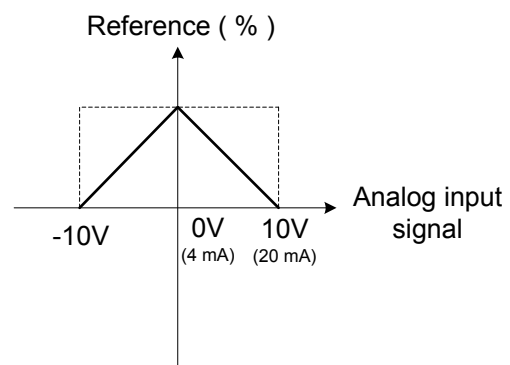

(b) Inverse / Negative Characteristics

Figure 4.4.10 Positive/negative analog input as main frequency reference command.

00-32	Application Selection **
Range	0: General 1: Reserved 2: Conveyor 3: Exhaust fan

Note: Before to set up 00-32 Application, it should do initialized setting (parameter 13-08) first. When setting 00-32, the I/O port function changed automatically. To avoid accident, be sure to confirm the I/O port signal of inverter and external terminal control

00-32=2: Conveyor

Parameter	Name	Value
00-00	Control mode selection	0: V/F
00-14	Acceleration time 1	3.0 sec
00-15	Deceleration time 1	3.0 sec
08-00	Stall prevention function	xx0xb: Stall prevention during deceleration

00-32=3: Exhaust fan

Parameter	Name	Value
00-00	Control mode selection	0: V/F
11-00	Direction lock selection	1: Forward direction only
01-00	V/F curve selection	F
07-00	Momentary power loss/ fault restart selection	1: Enable
08-00	Stall prevention function	xx0xb: Stall prevention during deceleration

01-V/F Control Parameters

01-00	V/F curve selection
Range	0~FF

The V/F curve selection is enabled for V/F mode with or SLV2 mode. Make sure to set the inverter input voltage parameter 01-14.

There are three ways to set V/F curve:

- (1) 01-00 = 0 to E: choose any of the 15 predefined curves (0 to E).
- (2) 01-00 = 0F, use 01-02~01-09 and 01-12~01-13, with voltage limit.
- (3) 01-00 = FF: use 01-02~01-09 and 01-12~01-13, without voltage limit. Refer to the following figure.

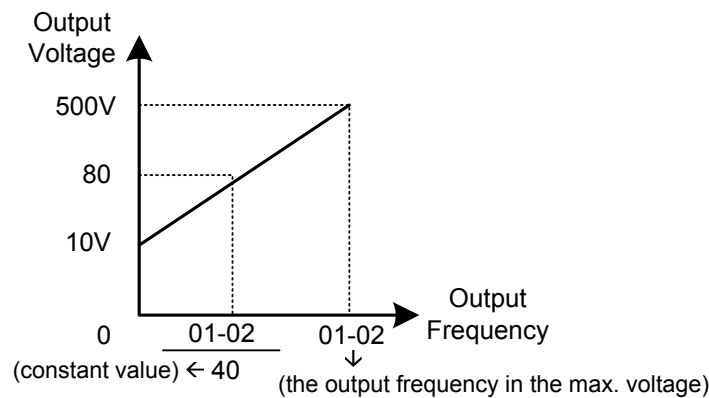

The default parameters (01-02~01-09) are the same when 01-00 is set to F (default) and 01-00 is set to 1.

Parameters 01-02 to 01-13 are automatically set when any of the predefined V/F curves are selected.

Note: This parameter is not affected by the initialization parameter (13-08).

Consider the following items as the conditions for selecting a V/F pattern.

- (1) The voltage and frequency characteristic of motor.
- (2) The maximum speed of motor.

Table 4.4.13: 15 - 30HP V/F curve selection (380V)

Type	Specification	01-00	V/F curve	Type	Specification	01-00	V/F curve	
General application	50Hz	0		High Starting Torque [†]	Low Starting Torque	8		
		F (50Hz Default setting)			High Starting Torque	9		
	60Hz	60Hz Saturation	1			Low Starting Torque	A	
		50Hz Saturation	2			Low Starting Torque	B	
Variable Torque Characteristic	72Hz	3		Constant-power torque (Reducer)	90Hz	C		
	50Hz	Variable Torque 1	4			120Hz	D	
		Variable Torque 2	5					
	60Hz	Variable Torque 3	6			180Hz	E	
		Variable Torque 4	7					

Table 4.4.14: 40HP and above V/F curve selection (380V)

Type	Specification	01-00	V/F curve	Type	Specification	01-00	V/F curve		
General application	50Hz	0		High Starting Torque ⁺	Low Starting Torque	8			
		F (50Hz Default setting)			High Starting Torque	9			
	60Hz	1			Low Starting Torque	A			
		F (60Hz Default setting)			Low Starting Torque	B			
Variable Torque Characteristic	72Hz	3		Constant-power torque (Reducer)	90Hz	C			
	50Hz	Variable Torque 1	4			120Hz	D		
		Variable Torque 2	5				180Hz	E	
	60Hz	Variable Torque 3	6			180Hz		E	
		Variable Torque 4	7						

Table 4.4.22: 15 - 30HP V/F curve selection (440V)

Type	Specification	01-00	V/F curve	Type	Specification	01-00	V/F curve
General application	50Hz	0		High Starting Torque ⁺	Low Starting Torque	8	
		F (50Hz Default setting)			High Starting Torque	9	
	60Hz	1			Low Starting Torque	A	
		F (60Hz Default setting)			Low Starting Torque	B	
Variable Torque Characteristic	72Hz	3		Constant-power torque (Reducer)	90Hz	C	
		50Hz	4			120Hz	D
	Variable Torque 2		5			180Hz	E
	60Hz	6					
		Variable Torque 4	7				

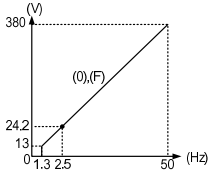
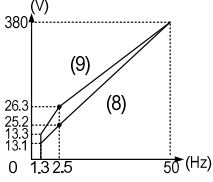
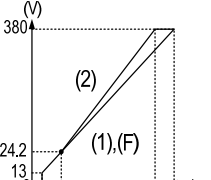
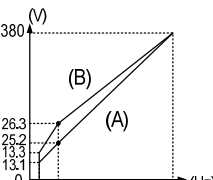
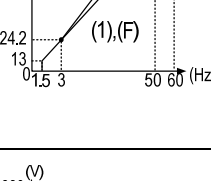
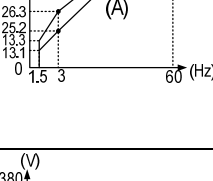
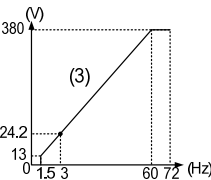
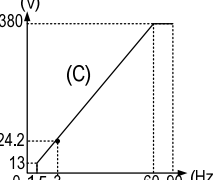
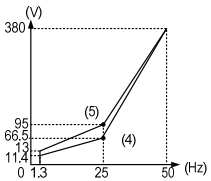
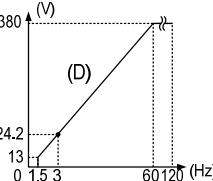
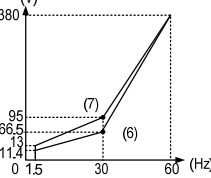
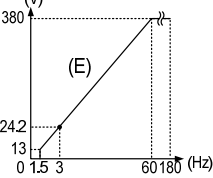
Table 4.4.23: 40HP and above V/F curve selection (440V)

Type	Specification	01-00	V/F curve	Type	Specification	01-00	V/F curve	
General application	50Hz	0		High Starting Torque ⁺	Low Starting Torque	8		
		F (50Hz Default setting)			High Starting Torque	9		
	60Hz	1			Low Starting Torque	A		
		60Hz Saturation			F (60Hz Default setting)	Low Starting Torque	B	
Variable Torque Characteristic	72Hz	3		Constant-power torque (Reducer)	90Hz	C		
	50Hz	Variable Torque 1	4			120Hz	D	
		Variable Torque 2	5			180Hz	E	
	60Hz	Variable Torque 3	6					
		Variable Torque 4	7					

01-02	Maximum output frequency of motor 1
Range	4.8~599.0 Hz
01-03	Maximum output voltage of motor 1
Range	380V: 0.2~480.0 V
01-04	Middle output frequency 2 of motor 1
Range	0.0~599.0 Hz
01-05	Middle output voltage 2 of motor 1
Range	380V: 0.0~480.0 V
01-06	Middle output frequency 1 of motor 1
Range	0.0~599.0 Hz
01-07	Middle output voltage 1 of motor 1
Range	380V: 0.0~480.0 V
01-08	Minimum output frequency of motor 1
Range	0.0~599.0 Hz
01-09	Minimum output voltage of the motor 1
Range	380V: 0.0~480.0 V
01-12	Base frequency of motor 1
Range	4.8~599.0 Hz
01-13	Base output voltage of motor 1
Range	380V: 0.0~480.0 V

V/F curve setting (01-02~01-09 and 01-12~01-13)

Select any of the predefined V/F curves setting '0' to 'E' that best matches your application and the load characteristic of your motor, choose a custom curve setting 'F' or 'FF' to set a custom curve.

Important:

Improper V/F curve selection can result in low motor torque or increased current due to excitation.

For low torque or high speed applications, the motor may overheat. Make sure to provide adequate cooling when operating the motor under these conditions for a longer period of time.

If the automatic torque boost function is enabled (parameter 01-10), the applied motor voltage will automatically change to provide adequate motor torque during start or operating at low frequency.

Custom V/F Curve Setting:

A custom curve selection allows users to set parameters 01-02 ~ 01-13 whereas a predefined curve selection does not.

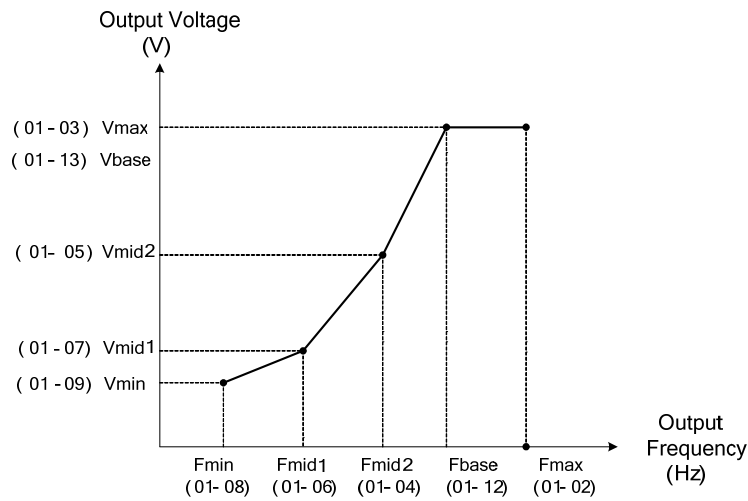

Figure 4.4.12 Custom V/F curve

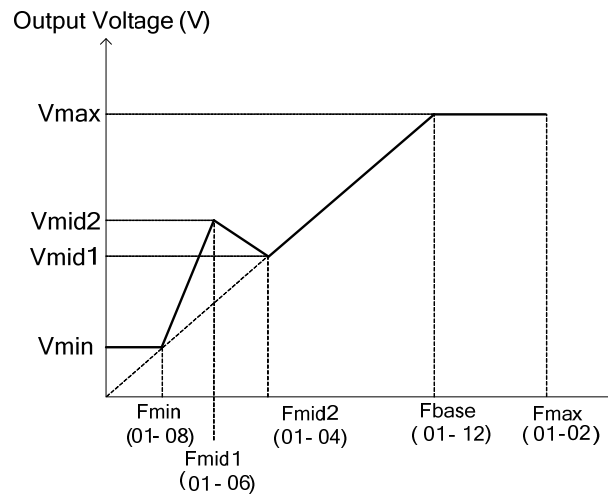

Figure 4.4.13 Torque boosting

When setting the frequency related parameters for a custom V/F curve values make sure that:

$$F_{\max} > F_{\text{base}} > F_{\text{mid2}} > F_{\text{mid1}} > F_{\min}$$

(01-02) (01-12) (01-04) (01-06) (01-08)

The 'SE03' V/F curve tuning error is displayed when the frequency values are set incorrectly.

When 01-04 and 01-05 (or 01-18 and 01-19) are set to 0, the inverter ignores the set values of Fmid2 and Vmid2.

The voltage values for 01-02~01-09 are irrelevant.

The value for maximum output voltage of motor 1(01-03) and the value for base output voltage of motor 1(01-13) will depend on restore factory setting(13-08) to set the value of voltage.

When the control mode is changed parameter 00-00, 01-08 (F_{\min}) and 01-09 (V_{\min}) will automatically be changed to the default setting of the selected control mode.

SLV Mode (Sensorless Vector Control)

Enter the motor data in parameter group 17 for SLV control mode (00-00) and perform auto-tuning.

In the SLV mode the V/F curve normally does not have to be re-adjusted after a successful auto-tune.

The maximum output frequency setting 01-02 (Fmax), base frequency 01-12 (Fbase), minimum output frequency 01-08 (Fmin), maximum output voltage 01-03 (Vmax) or base output voltage 01-13 (Vbase) can be adjusted but the voltage is automatically adjusted by the internal current controller.

Set the base frequency (01-12, Fbase) to the motor rated frequency on the motor nameplate.

Perform the auto-tuning procedure after adjusting parameters 02-19 or 17-04 to reduce the voltage at no-load operation.

Motor jitter can be reduced by lowering the no-load voltage. Please note that lowering the no-load voltage increases the current at no-load.

*** The setting of V/F curve in SLV2 is the same as that in VF mode.**

01-10	Torque compensation gain
Range	0.0~2.0

In V/F and SLV2 mode the inverter automatically adjusts the output voltage to adjust the output torque during start or during load changes based on the calculated loss of motor voltage.

Torque compensation gain (01-10) can adjust in the running time. No need to adjust in general except the following:

- If the wire between inverter and motor is too long, add the value of 01-10
- If the capacity of motor is smaller than inverter, add the value of 01-10.
- If the motor vibrates, reduce the value of 01-10

Refer to the torque compensation gain adjustment shown in Figure 4.4.14.

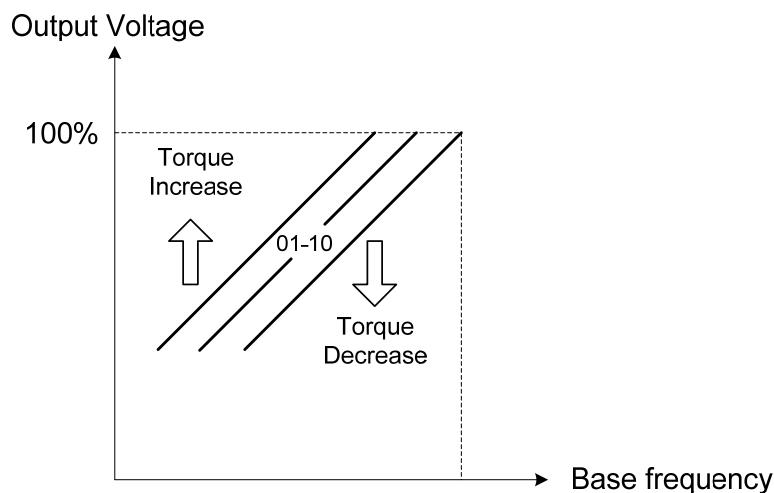

Figure 4.4.14 Torque compensation gain to increase/decrease output torque

Increase value when:

- The wiring between the inverter and the motor very too long
- The motor size is smaller than the inverter size

Note: Gradually increase the torque compensation value and make sure the output current does not exceed inverter rated current.

Reduce value when:

- When experiencing motor vibration

Important:

Confirm that the output current at low speed does not exceed the rated output current of the inverter.

01-11	Selection of Torque Compensation Mode
Range	0: Torque Compensation Mode 0 1: Torque Compensation Mode 1

Torque compensation mode 0 is the general mode.

Torque Compensation Mode 1 is the high speed mode (120~160Hz) and the compensation amount decreases as

the increasing frequency. When the speed is at 0~120Hz, the compensation amount is the same as that in Torque compensation mode 0.

01-14	Input voltage setting
Range	380V: 310.0~480.0 V

The minimum input voltage of inverter is 0.1V.

Set the inverter input voltage (E.g. 380V / 415V / 440V).

This parameter is used as a reference for predefined V/F curve calculation (01-00 = 0 to E), over-voltage protection level, stall prevention, etc...

Note: It will depend on restore factory setting(13-08) to set the value of voltage

01-15	Torque compensation time
Range	0~10000 ms

Set the torque compensation delay time in milliseconds.

Only adjust in the following situations:

Increase value when:

- When experiencing motor vibration

Decrease value when:

- When motor torque response is too slow

01- 16	Maximum output frequency of motor 2
Range	4.8~599.0 Hz

01- 17	Maximum output voltage of motor 2
Range	380V: 0.2~480.0 V

01- 18	Middle output frequency 2 of motor 2
Range	0.0~480.0 Hz

01- 19	Middle output voltage 2 of motor 2
Range	380V: 0.0~480.0 V

01- 20	Middle output frequency 1 of motor 2
Range	0.0~599.0 Hz

01- 21	Middle output voltage 1 of motor 2
Range	380V: 0.0~480.0 V

01- 22	Minimum output frequency of motor 2
Range	0.0~599.0 Hz

01-23	Minimum output voltage of motor 2
Range	380V: 0.0~480.0 V
01- 24	Base frequency of motor 2
Range	4.8~599.0 Hz
01- 25	Base voltage of motor 2
Range	380V: 0.0~480.0 V
01- 26	V/F Curve Selection of Motor 2
Range	0~FF

Note: Motor 2 V/F curve uses the same settings as motor 1.

Note: Motor 2 V/F curve is the same as Motor 1, please refer to Table 4.4.13~14, 4.4.22~23

02 - IM Motor Parameters	
02-00	No-load current of motor 1
Range	0.01~600.00 A
02-01	Rated current of motor 1
Range	V/F mode is 10%~200% of inverter's rated current. SLV mode is 25%~200% of inverter's rated current.
02-03	Rated rotation speed of motor1
Range	0~60000 rpm
02-04	Rated voltage of motor1
Range	380V: 100.0~480.0 V
02-05	Rated power of motor 1
Range	0.01~600.00 KW
02-06	Rated frequency of motor 1
Range	4.8~599.0 Hz+
02-07	Pole of motor 1
Range	2~16
02-09	Excitation current of motor 1 <1>
Range	15.0~70.0 %
02-10	Core saturation coefficient 1 of motor 1 <1>
Range	1~100 %
02-11	Core saturation coefficient 2 of motor 1 <1>
Range	1~100 %
02-12	Core saturation coefficient 3 of motor 1 <1>
Range	80~300 %
02-13	Core loss of motor 1
Range	0.0~15.0 %
02-15	Resistance between wires of motor 1
Range	0.001~60.000 Ω
02-19	No-Load Voltage of motor 1
Range	380V: 100~480 V

Motor parameters are automatically set when performing an auto-tune (17-10=1). In most case no adjustment is required after performing an auto-tune except when using the inverter in special applications (e.g. machine tool, positioning, etc...).

(1) Number of motor poles (02-07)

Set the number of motor pole according to the motor nameplate.

(2) Motor rated power (02-05)

Set the motor power according to the motor nameplate.

(3) Motor rated current (02-01)

Set the motor rated current according to the motor nameplate.

(4) Motor rated voltage (02-04)

Set the motor rated voltage according to the motor nameplate.

Set the motor rated voltage and it will adjust maximum output voltage of V/F curve.

(5) Rated frequency of motor 1 (02-06)

Set the motor rated frequency according to the motor nameplate.

(6) Rated rotation speed of motor 1 (02-03)

Set the motor rpm according to the motor nameplate.

(7) No-load motor voltage (02-19)

Parameter determines the rated flux during motor's rated rotation in SLV control mode. Set the value of this parameter to the same value as parameter 17-08. A value of 10~50V below the input voltage level ensures that the motor is capable of providing adequate torque performance when operating at nominal speed (or higher speed). Setting the value to small can result in a reduction in no-load current, weakened motor flux and an increase in motor current while the motor is loaded.

(8) Motor excitation current (02-09)

The current is obtained from rotational auto-tuning. It is required to perform manual tuning if the inverter cannot rotational auto-tune.

When the manual tuning is performed, tune it from 33% and observe no-load voltage (the output value) of parameter 12-67. If parameter 12-67 is higher than no-load voltage (the setting value) of parameter 17-08, perform downward revision in parameter 02-09; if it is lower than that, perform upward revision in parameter 02-09.

Tuning motor excitation current of parameter 02-09 will change motor leakage inductance of parameter 02-17 and motor mutual inductance of parameter 02-18.

It is required to refer to the actual no-load voltage of parameter 12-76 to tune the motor excitation current of parameter 02-09. Change of the excitation current will also affect the relative actual no-load voltage fluctuation so it is required to tune to the similar setting value of no-load voltage (17-08). 1

(9) Setting of motor core's saturation coefficient 1, 2 and 3 (02-10, 02-11, 02-12)

These parameters are automatically set during auto-tune. No adjustment required. Parameters are set to 50% for 02-10, 75% for 02-11 and 137.5% for 02-12 to reduce the impact of core saturation. The motor core's saturation coefficient is defined as a percentage of the motor excitation current. When the motor flux reaches 137.5% level, the core's saturation coefficient shall be greater than 137.5%. When the motor flux is 50% or 75%, the core's saturation coefficient is required to be less than 50% and 75%.

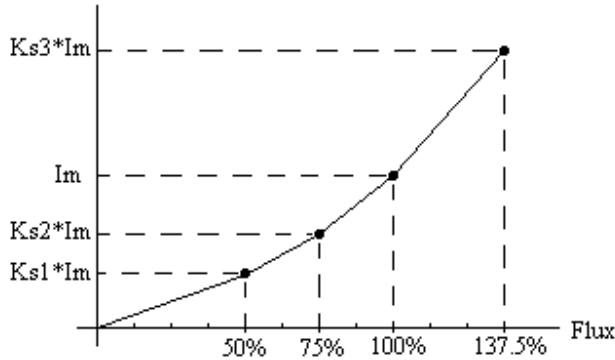

Im : 02-09 Excitation Current
Ks1: 02-10 Motor Core Saturation Coefficients 1
Ks2: 02-11 Motor Core Saturation Coefficients 2
Ks3: 02-12 Motor Core Saturation Coefficients 3

(10) Motor core loss (02-13)
Set motor core loss as the percentage of the motor rated power.

$$\% W_{\text{core}} (02-13) = \frac{3 \times \text{Motor core loss (watt)}}{\text{Motor rated power (watts, 02-05)}} \times 100\%$$

Note: In V/F mode motor core loss (02-13) is used to for torque compensation.

(11) Motor line to line resistance (02-15)

(12) Motor no-load current (02-00).

Value is calculated based on the motor rated frequency (17-05) and motor rated current (17-03).

In V / F control mode, the output current is greater than the no-load current with slip compensation is enabled.

Note: The value of 02-01 needs to be greater than the value set in parameter 02-00, otherwise warning message "SE01" out of range error will be displayed.

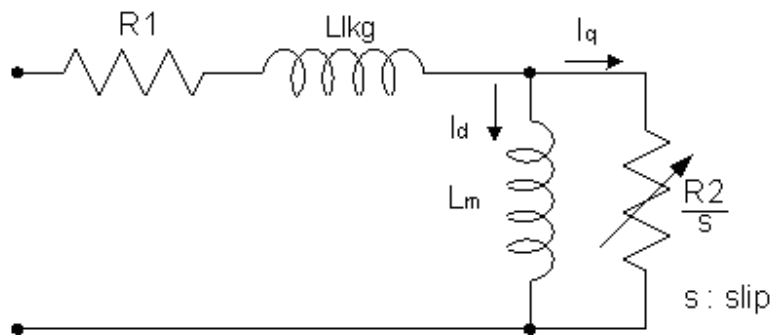

Figure 4.4.15 Y-equivalent model an induction motor

02-20	No-Load Current of motor 2
Range	0.01~600.00 A
02-21	Rated current of motor 2
Range	10%~200% of inverter's rated current
02-22	Rated rotation speed of motor 2
Range	0~ 60000 rpm
02- 23	Rated voltage of motor 2
Range	380V: 100.0~480.0 V

02- 24	Rated power of motor 2
Range	0.01~600.00 kW

02-25	Rated frequency of motor 2
Range	4.8~599.0 Hz

02-26	Pole of motor 2
Range	2~16

02-32	Resistance between wires of motor 2
Range	0.001~60.000 Ω

Note: Motor 2 V/F curve uses the same settings as motor 1. The control mode setting for motor 2 is fixed to V/F.

02-33	Proportion of Motor 1 Leakage Inductance <1>
Range	0.1~15.0 %

It is set by manual tuning function. Normally, it does not need to be adjusted because magnetic function does not exist in this adjustment.

$$\xi = \frac{LlKg}{Lr}$$

Definition of leakage inductance proportion is the ratio of leakage inductance to rotor inductance. If the default value is set to 3.4%, adjust this ratio will affect the motor leakage inductance parameter to be changed.

When the adjustment of leakage inductance proportion is larger or smaller, it will cause the motor jittering with abnormal noise and the motor cannot run. Generally, the adjusted value is 3.0%~5.0%. 4.0% is the universal adjustment value that can make the motor run normally. The adjustment of leakage inductance proportion depends on the motor rating.

02-34	Motor 1 Slip Frequency <1>
Range	0.1~20.0 Hz

Normally, it is not required to be adjusted. It can be obtained via manual tuning parameter function. Such tuning does not have magnetic function.

The default value of motor slip is set to 1 Hz. Motor slip is obtained from the nameplate.

Take 60Hz, 4-pole motor for example, synchronous speed: $N = \frac{120 \times \text{Frequency}}{\text{Pole}} = \frac{120 \times 60}{4} = 1800 \text{ rpm}$

Rated speed in the nameplate is 1700 rpm, then $\text{Slip} = \frac{1800 - 1700}{60} = 1.67 \text{ Hz}$.

Adjusting motor slip will change the rotor resistance parameter. The motor slip is adjusted depending on the motor performance.

02-37	Motor Mechanical Loss
Range	0.0~10.0 %

Adjustment range of mechanical loss is 0.0~10.0%. It is enabled only in the speed mode and the speed command being 0.

If the speed command is 0 and the shaft will be at slow drift causing to be static incompletely, adjust upwards the range of mechanical loss until the shaft is completely static.

Note: After executing auto-tuning, parameters which marked <1> will renew the value. Please refer Group 17: Automatic Tuning Parameters for more detail.

03- External Digital Input and Output Parameters

03-00	Multi-function terminal function setting – S1
03-01	Multi-function terminal function setting – S2
03-02	Multi-function terminal function setting – S3
03-03	Multi-function terminal function setting – S4
03-04	Multi-function terminal function setting – S5
03-05	Multi-function terminal function setting – S6
Range	<p> 0: 2-Wire sequence (ON: Forward run command) 1: 2-Wire sequence (ON: Reverse run command) 2: Multi-speed/position setting command 1 3: Multi-speed/position setting command 2 4: Multi-speed/position setting command 3 5: Multi-speed/position setting command 4 6: Forward jog run command 7: Reverse jog run command 8: UP frequency increasing command 9: DOWN frequency decreasing command 10: Acceleration/deceleration time selection 1 11: Inhibit Acceleration/deceleration Command 12: Main/ Alternative Run Switch Function 13: Main/ Alternative Frequency Switch Function 14: Emergency stop (decelerate to zero and stop) 15: External Baseblock Command(rotation freely to stop) 16: PID control disable 17: Fault reset (RESET) 18: Reserved 19: Speed Search 1 (from the maximum frequency) 20: Manual energy saving function 21: PID integral reset 22~24: Reserved 25: External fault 26: 3-Wire sequence (Forward/Reverse command) 27: Local/Remote selection 28: Remote mode selection 29: Jog frequency selection 30: Acceleration/deceleration time selection 2 31: Inverter overheating warning 32: Sync command 33: DC braking 34: Speed Search 2 (from the frequency command) 35: Time function input 36: PID Soft start disabled 37: Traversing operation 38: Upper Deviation of traverse operation 39: Lower Deviation of traverse operation 40: Switching between motor 1/motor 2 41: PID Sleep 42~46: Reserved 47: Fire Mode (Forced Operation mode) </p>

<p>48: KEB acceleration 49: Parameter writing allowable 50: Unattended Start Protection (USP) 51~52: Reserved 53: 2-Wire Self Holding Mode (Stop Command) 54~57: Reserved 58: Safety Function 59~61: Reserved 62: EPS Function</p>

Refer to the multi-function digital input and related parameters in the following figure 4.4.16.

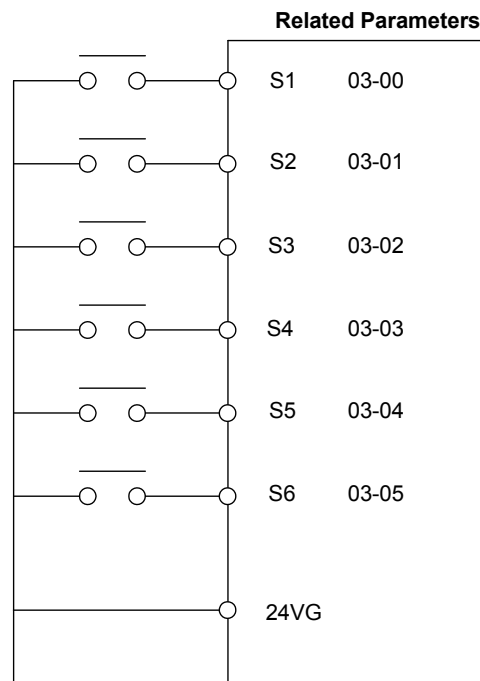

Figure 4.4.16 Multi-function digital input and related parameters

Table 4.4.27 Multi-function digital input setting (03-00 to 03-05) (“O”: Enable, “X”: Disable)

Value	Function Name	Description	Control mode		
			V/F	SLV	SLV2
0	2-wire type (Forward operation)	2- wire (ON : Forward operation command).	O	O	O
1	2-wire type (Reverse operation)	2- wire (ON : Reverse operation command).	O	O	O
2	Multi-speed/position setting command 1	Multi-Speed Reference /Position Reference 1	O	O	O
3	Multi-speed/position setting command 2	Multi-Speed Reference /Position Reference 2	O	O	O
4	Multi-speed/position setting command 3	Multi-speed Reference /Position Reference 3	O	O	O
5	Multi-speed/position setting command 4	Multi-speed Reference /Position Reference 4	O	O	O
6	Forward jog run command	ON: Forward operation in jog mode (00-18).	O	O	O
7	Reverse jog run command	ON: Reverse operation in jog mode (00-18).	O	O	O
8	UP frequency increasing command	ON: Command of output frequency increasing (only used by support of DOWN command).	O	O	O
9	DOWN frequency decreasing command	ON: Command of output frequency decreasing (only used by support of UP command).	O	O	O
10	Acceleration/deceleration time selection 1	Acceleration/deceleration time selection command 1	O	O	O
11	Acceleration/deceleration Inhibition Command	ON: Acceleration/ deceleration prohibition	O	O	O
12	Main/ Alternative Run Switch Function	Run Command Source is set in parameter of alternative frequency command (00-03)	O	O	O
13	Main/ Alternative Frequency Switch Function	Frequency Command Source is set in parameter of alternative frequency command (00-06)	O	O	O
14	Emergency stop (decelerate to zero and stop)	ON: Emergency stop input	O	O	O
15	External baseblock command (rotation freely to stop)	ON: Inverter base interdiction	O	O	O
16	PID control disabled	ON: PID control disabled	O	O	O
17	Fault reset	Fault reset	O	O	O
18	Reserved	Reserved	-	-	-
19	Speed Search 1 (from the maximum frequency)	ON: Search the speed from the maximum output frequency	O	O	O
20	Manual energy saving function	ON: Manual energy saving control is based on the settings of 11-12 and 11-18.	O	X	X
21	PID integral reset	ON: PID integral value reset	O	O	O
22	Reserved	Reserved	-	-	-
23	Reserved	Reserved	-	-	-
24	Reserved	Reserved	-	-	-
25	External fault	ON: External fault alarm	O	O	O
26	3-Wire sequence (Forward/Reverse command)	3-wire control (forward/reverse command). ON: Reverse; OFF: Forward. When the parameter is set to 26 , terminal S1 and terminal will become operation command and stop command respectively, and their original functions will be closed.	O	O	O

Value	Function Name	Description	Control mode		
			V/F	SLV	SLV2
27	Local/Remote selection	ON: Local mode (via the digital operator) OFF: Frequency command and operation command will be determined according to the setting of parameter (00-02 and 00-05).	0	0	0
28	Remote mode selection	ON: RS-485 communication OFF: Control circuit terminal	0	0	0
29	Jog frequency Selection	ON: Select jog frequency command	0	0	0
30	Acceleration/deceleration time selection 2	Acceleration/ deceleration time selection command 2	0	0	0
31	Inverter overheating warning	ON: Inverter overheat alarm (OH2) input (will display OH2)	0	0	0
32	Sync command	ON: Synchronous speed start OFF: Synchronous speed close (Start other frequency command).	0	0	0
33	DC braking	ON: Perform DC braking	0	0	0
34	Speed Search 2 (from the frequency command)	ON: Search speed from set frequency	0	0	0
35	Time function input	.Set the time function at 03-33, 03-34 .Set the time function output at 03-11, 03-12	0	0	0
36	PID Soft start ineffective	ON: PID slow-start off	0	0	0
37	Traversing operation	ON: Frequency wobbling operation	0	X	0
38	Upper Deviation of traverse operation	ON: Upper offset off frequency wobbling	0	X	0
39	Lower Deviation of traverse operation	ON: Lower offset off frequency wobbling	0	X	0
40	Switching between motor 1/motor 2	ON: Start motor 2	0	0	0
41	PID Sleep	ON: PID Sleep	0	0	0
42	Reserved	Reserved	-	-	-
43	Reserved	Reserved	-	-	-
44	Reserved	Reserved	-	-	-
45	Reserved	Reserved	-	-	-
46	Reserved	Reserved	-	-	-
47	Fire Mode	ON: Turn off hardware and software fault or alarm protection and run the inverter with value of 01-02 (a special application of HVAC)	0	0	0
48	KEB acceleration	ON: KEB acceleration start	0	X	0
49	Parameters writing allowable	ON: all parameters are writable OFF: Except reference frequency (00-05) all parameters are write-protected.	0	0	0
50	Unattended Start Protection (USP)	ON: After power is input, the inverter ignores the operation command OFF: After power is input, the inverter will return the operation status before power is cut off.	0	0	0
51	Reserved	Reserved	-	-	-
52	Reserved	Reserved	-	-	-
53	2-Wire Self Holding Mode (Stop Command)	2-Wire Self Holding Mode (ON: Stop Command).	0	0	0
54	Reserved	Reserved	-	-	-
55	Reserved	Reserved	-	-	-
56	Reserved	Reserved	-	-	-
57	Reserved	Reserved	-	-	-
58	Safety Function	ON: Stop by the setting of 08-30	0	0	0
59	Reserved	Reserved	-	-	-

Value	Function Name	Description	Control mode		
			V/F	SLV	SLV2
60	Reserved	Reserved	-	-	-
61	Reserved	Reserved	-	-	-
62	EPS function	ON:EPS input	X	X	X

03-0X =00: 2-wire control: forward operation

03-0X =01: 2-wire control: reverse operation. Refer to the 2-wire operation mode in Figure 4.4.1.

03-0X =02: Multi-speed/position setting command 1.

03-0X =03: Multi-speed/position setting command 2.

03-0X =04: Multi-speed/position setting command 3.

03-0X =05: Multi-speed/position setting command 4 (setting =05).

Select frequency reference using multi-function digital input.

03-0X =29: Jog frequency selection (setting =29). Select frequency reference using the multi-function digital input.

Table 4.4.28 Multi-speed operation selection

Speed	Multi-function digital input (S1 to S6) *4					Frequency selection
	Jog frequency reference	Multi-speed frequency 4	Multi-speed frequency 3	Multi-speed frequency 2	Multi-speed frequency 1	
1	0	0	0	0	0	Frequency command 0 (05-01) or main speed frequency *2
2	0	0	0	0	1	frequency reference 1 (05-02)
3	0	0	0	1	0	Frequency command 2 (05-03)
4	0	0	0	1	1	Frequency command 3 (05-04)
5	0	0	1	0	0	Frequency command 4 (05-05)
6	0	0	1	0	1	Frequency command 5 (05-06)
7	0	0	1	1	0	Frequency command 6 (05-07)
8	0	0	1	1	1	Frequency command 7 (05-08)
9	0	1	0	0	0	Frequency command 8 (05-09)
10	0	1	0	0	1	Frequency command 9 (05-10)
11	0	1	0	1	0	Frequency command 10(05-11)
12	0	1	0	1	1	Frequency command 11 (05-12)
13	0	1	1	0	0	Frequency command 12 (05-13)
14	0	1	1	0	1	Frequency command 13(05-14)
15	0	1	1	1	0	Frequency command 14 (05-15)
16	0	1	1	1	1	Frequency command 15 (05-16)
17	1**	—	—	—	—	Jog frequency command (00-18)

0: OFF, 1: ON, -: Ignore

*1. Jog frequency terminal has a higher priority than multi-speed reference 1 to 4.

*2. When parameter 00-05=0 (frequency reference input = digital operator), multi-speed frequency 1 will be set by 05-01 frequency reference setting1). When parameter 00-05=1 (frequency reference input=control circuit terminal), multi-speed frequency command 1 is input through analog command terminal A11 or A12).

*3. When PID control mode 10-03=xxx1b (PID Enable), even though 03-00~03-05=16 (PID Control Disable), the Multi-speed frequency will be ignored.

Wiring Example: Figure 4.4.17 and 4.4.18 show an example of a 9-speed operation selection.

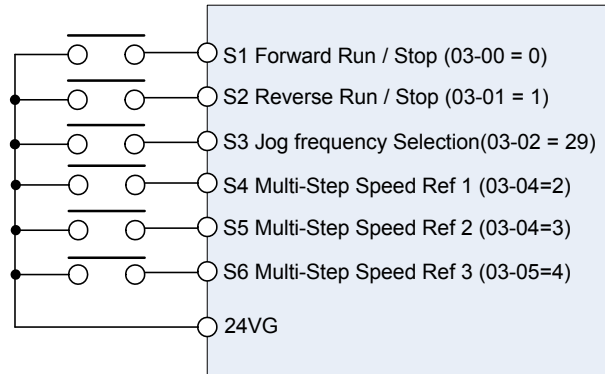

Figure 4.4.17 Control Terminal Wiring Example

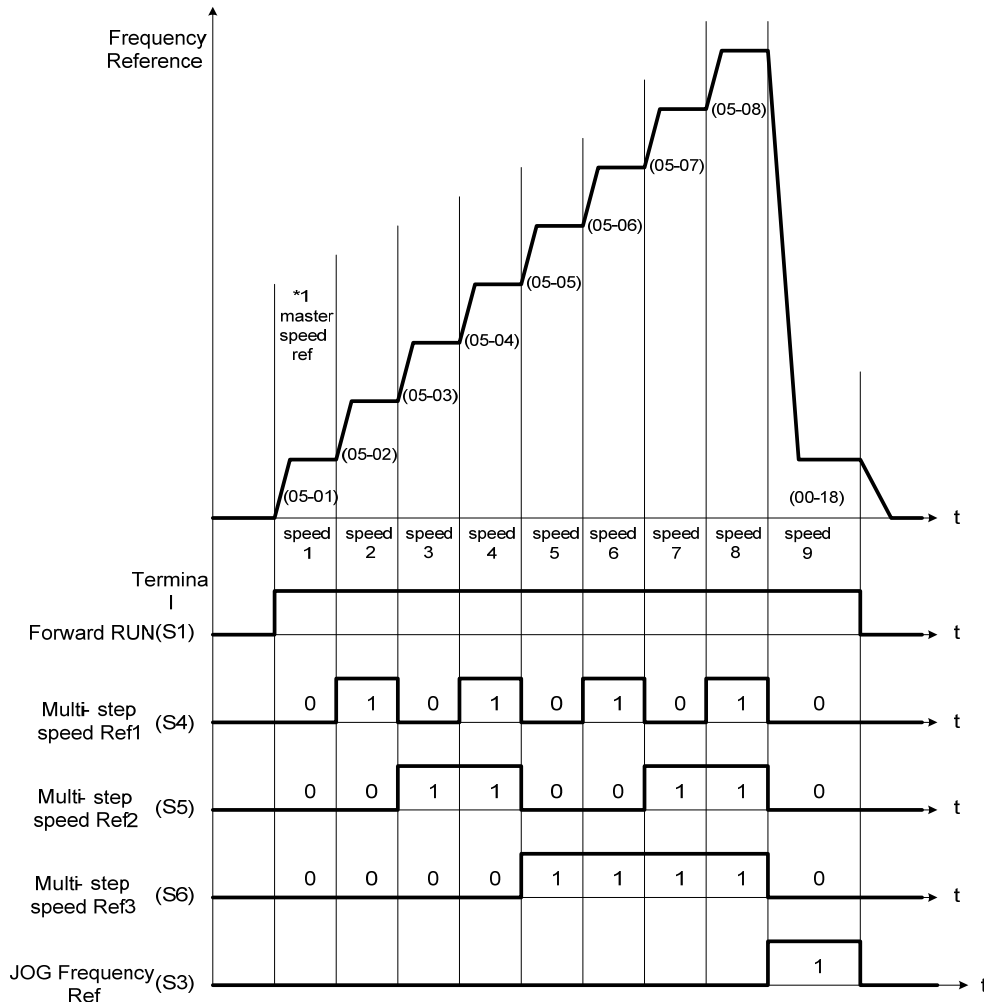

Figure 4.4.18: 9-speed timing diagram

*1. When 00-05=1, multi-speed frequency reference is set by analog input AI1 or AI2. When 00-05=0, multi-speed frequency reference is set by 05-01.

03-0X =06: Forward jog run command, uses jog frequency parameter 00-18.

Note:

- Jog command has a higher priority than other frequency reference commands.
- Jog command uses stop mode set in parameter 07-09 when Jog command is active > 500ms.

03-0X =07: Reverse jog run command, uses jog frequency parameter 00-18.

Note:

- Jog command has a higher priority than other frequency reference commands.
- Jog command uses stop mode set in parameter 07-09 when Jog command is active > 500ms.

03-0X =08: UP frequency accelerating command; set parameter 00-05 Frequency command to 2 to activate.

03-0X =09: Down frequency decelerating command; set parameter 00-05 Frequency command to 2 to activate.

Note:

- The inverter operates the variation of increasing/ decreasing output frequency via keypad (refer to parameter 11-56) / external multi-function digital input (terminal S1 to S6) when the motor is running.
- It is required to use two terminals to run UP/ DOWN command when the inverter runs this command via the external multi-function digital input terminal and 00-02=1 (external terminals) & 00-05=2 (terminal command UP/DOWN) & 03-00~03-05=8 (UP command)/ 9 (DOWN command).
- The inverter output frequency runs UP/ DOWN command with the setting of acceleration/ deceleration time.

Note: SE02 DI terminal Error will be displayed when:

- Only the UP or DOWN command function is set.
- Both UP command and Inhibit Acceleration/deceleration command are activated simultaneously.
- Both DOWN command and Inhibit Acceleration/deceleration command are activated simultaneously.

For the examples of UP/DOWN control wiring and operation, please refer to figure 4.4.19 and 4.4.20.

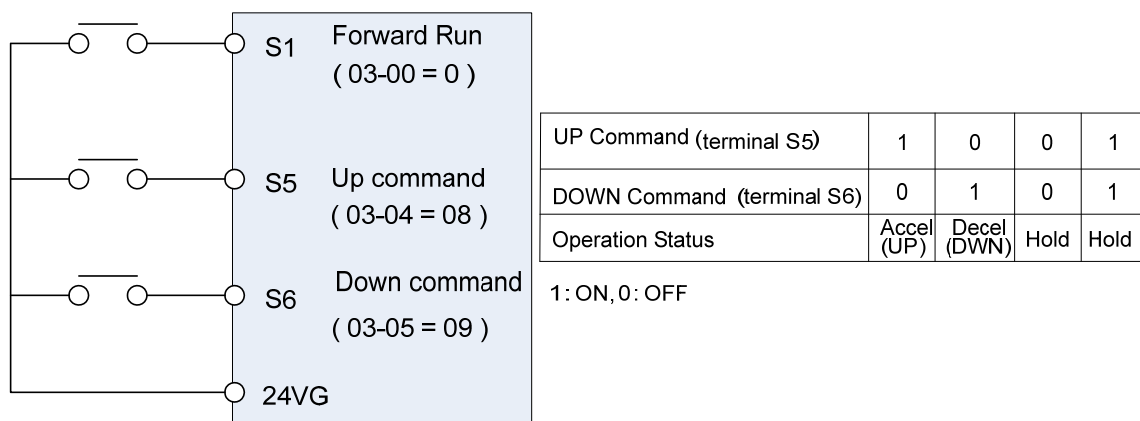

Figure 4.4.19 UP/DOWN wiring and operation example

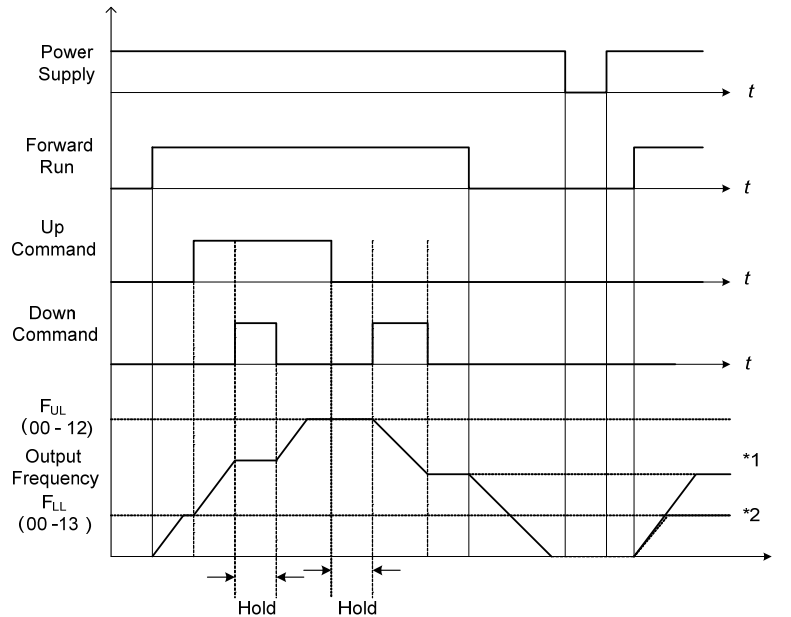

Figure 4.4.20 Up / Down command timing diagram

UP / DOWN Command Operation

When the Forward Run command is active and the UP or Down command is momentarily activated the inverter will accelerate the motor up to the lower limit of the frequency reference (00-13).

When using the UP / Down command, the output frequency is limited to the upper limit of frequency reference (00-12) and the lower limit of frequency reference (00-13).

The UP / DOWN command uses acceleration 1 or 2 / deceleration time 1 or 2 for normal operation Tacc1 / Tdec1 (00-14, 00-15) or Tacc2 / Tdec2 (00-16, 00-17).

*Refer to parameter 03-40 of UP/ Down frequency width setting for other functions of UP / Down.

Frequency reference retention is active when parameter 11-58 is set to 1 and the frequency reference is saved when power is lost and retrieved when power is restored.

*1: When 11-58 = 1 and the operation command is active, the output frequency will accelerate to the previously stored frequency command.

*2: When 11-58 = 0 and the operation command is active, the output frequency will accelerate to the lower limit of frequency reference (00-13).

03-0X =10: Acceleration/deceleration 1 selection

03-0X =30: Acceleration/deceleration 2 selection

Refer to the "multi-function digital input terminals select acceleration / deceleration time" page 4-76.

03-0X =11: Acceleration/deceleration inhibition command (hold command)

When acceleration/deceleration inhibition command is active, inverter suspends the motor's acceleration / deceleration operation and maintains the output frequency at current level. Refer to the record reference frequency (parameter 11-58).

*1. 11-58 = 1,

When acceleration / deceleration inhibition command is activated, the frequency reference is stored even when powering down the inverter.

When a run command is given (e.g. run forward) and the acceleration / deceleration inhibit command is active, the inverter will accelerate to the previously stored frequency reference.

*2. 11-58 = 0,

When acceleration / deceleration inhibition command is ON, the motor suspends at the output frequency which is the frequency reference command.

When acceleration / deceleration inhibition command is OFF or inverter stop command is active, the frequency reference command will restore to the pre-set frequency. The output frequency remains at 0 Hz when the stop command and power down reset.

Note: If acceleration / deceleration inhibition command is ON before operation, STP0 signal will occur after operation because there is no record reference frequency.

Refer to Figure 4.4.21. for an example.

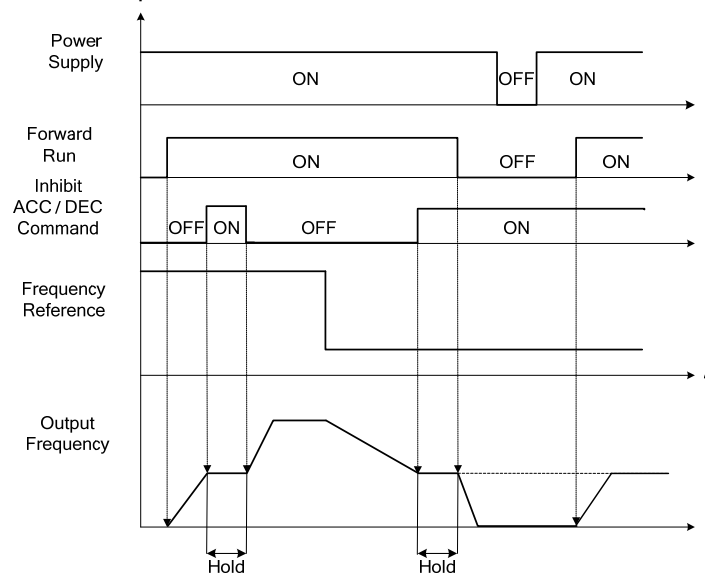

Figure 4.4.21 Acceleration/ deceleration inhibition command operation

03-0X =12: Main/ Alternative Run Switch Function

When function terminals conduct, run command source is set in alternative run command (00-03). When functional terminal is set to 27 (Local/ Remote control selection), it will be precedential to main/alternative run switch.

03-0X =13: Main/ Alternative Frequency Switch Function

When function terminals conduct, frequency command source is set in alternative frequency command (00-06). When functional terminal is set to 27 (Local/ Remote control selection), it will be precedential to main/alternative frequency switch. When PID function is active(10-03=XXX1B),this function is invalid and main frequency is switched to PID function. When PID function is invalid, Main/ Alternative frequency switch function is valid then.

03-0X =14: Emergency stop (decelerate to zero and stop)

Refer to the "deceleration time of emergency stop" of parameter 00-26

03-0X =15: External Baseblock Command (coast to stop)

Execute the base block command by the use of ON / OFF way of multi-function digital input terminal, and prohibit

the inverter output.

During run: When an external base block command is activated, the keypad displays "BBn BaseBlock (Sn)", indicating the inverter output is turned off (n indicates the digital input number 1 – 6). Upon removing the base block signal, the motor will run at the frequency reference. If speed search from frequency reference is active the inverter output frequency starts from the frequency reference and searches for the coasting motor speed and continue to operate. If speed search is not active the output frequency starts at 0Hz.

During deceleration: When an external base block command is activated, the keypad displays "BBn BaseBlock (Sn)", indicating the inverter output is turned off (n indicates the digital input number 1 – 6). Upon removing the base block signal, the motor is stopped or will coast to a stop and the inverter will remains in the stop condition.

During acceleration: When an external base block command is activated, the keypad displays "BBn BaseBlock (Sn)", indicating the inverter output is turned off (n indicates the digital input number 1 – 6). Upon removing the base block signal, the motor will run at the frequency reference. If speed search from frequency reference is active the inverter output frequency starts from the frequency reference and searches for the coasting motor speed and continue to operate. If speed search is not active the output frequency starts at 0Hz.

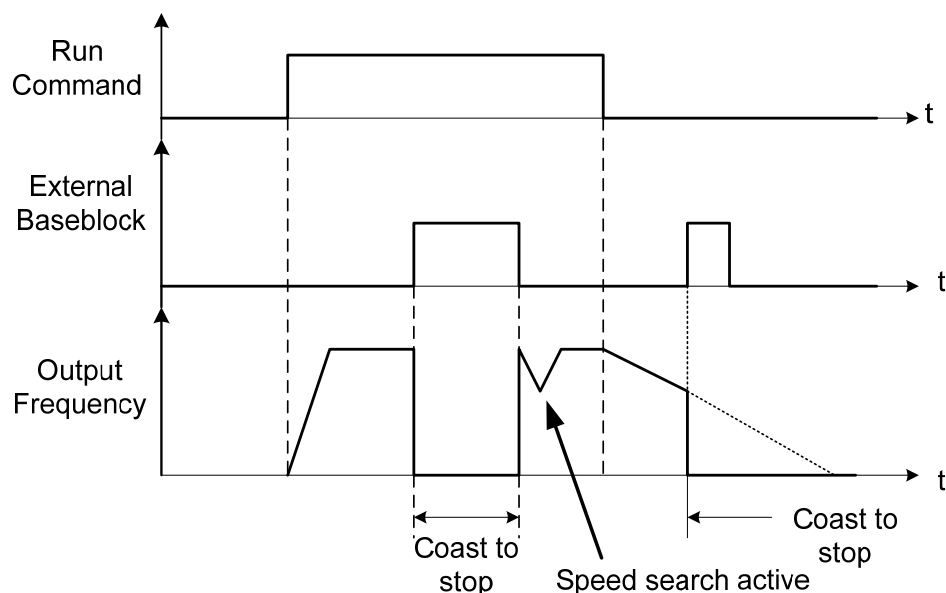

Figure 4.4.22 External base block operation

03-0X =16: PID control disabled.

03-0X =17: Fault reset

The output becomes active when the inverter trips on a fault. Upon an inverter fault the inverter output will turn off (base block) and the keypad displays the dedicated fault message.

When fault occurs, the following actions can be used to reset the fault:

1. Program one of the multi-function digital inputs (03-00 to 03-05) to 17 (reset fault) and active input.*
2. Press the reset key of the digital operator (RESET).*
3. Recycle power to the inverter.

Important Note: If a run command is active during power-up, the inverter will start running automatically.

* To reset an active fault the run command has to be removed.

03-0X =19: Speed Search 1 (from the maximum frequency).

03-0X =34: Speed Search 2 (from the frequency command).

Refer to the "speed search" function.

03-0X =20: Energy saving enabled

Manual energy savings function is set with parameters 11-12 and 11-18.

For the manual energy saving operation refer to Figure 4.4.88.

03-0X =21: PID integral reset

03-0X =25: External fault

Activating the external fault input will turn off the inverter output and the motor will coast to a stop. The keypad displays the external fault message "EFn Ext. Fault (Sn)", where n is the input terminal number.

03-0X =26: 3-wire sequence (forward / reverse command)

When digital input terminals S3~S6 are set to 26, terminals S1 and S2 will be individually changed to run command and stop command. Refer to the 3-wire operation mode in Figure 4.4.2 for details.

03-0X =27: Local / Remote selection.

Switch the inverter frequency reference source between Local (keypad) or Remote (control circuit terminals or RS485). Use parameter 00-05 (Main frequency command source selection) and 00-02 (Run command selection) to select the remote source.

Note: In 3-wire operation terminal S1 and S2 are reserved for run/stop operation and the Local / Remote function can only be set to digital input terminals S3 to S6 (03-02 to 03-05).

Note: To switch between local and remote the inverter has to be stopped.

Input	Mode	Frequency Reference / Run/Stop Command Source
ON	Local	- Frequency reference and Run-Stop from keypad.
OFF	Remote	- Frequency reference source selected by parameter 00-05 and Run-Stop source selected by parameter 00-02.

03-0X =28: Remote mode selection

Switch between terminal source and communication (RS-485) source for frequency reference and operation command.

In Remote mode, you can use terminals AI1 and AI2 to control the frequency command, and use terminals S1, S2 or communication terminal RS-485 to control the operation command.

Input	Mode	Frequency Reference / Run/Stop Command Source
ON	Communication	- Frequency reference and run/stop command control via communication (RS-485).
OFF	Terminal	- Frequency reference source from AI1 / AI2 input (00-05=1) and Run-Stop command from terminals S1 / S2 (00-02=1).

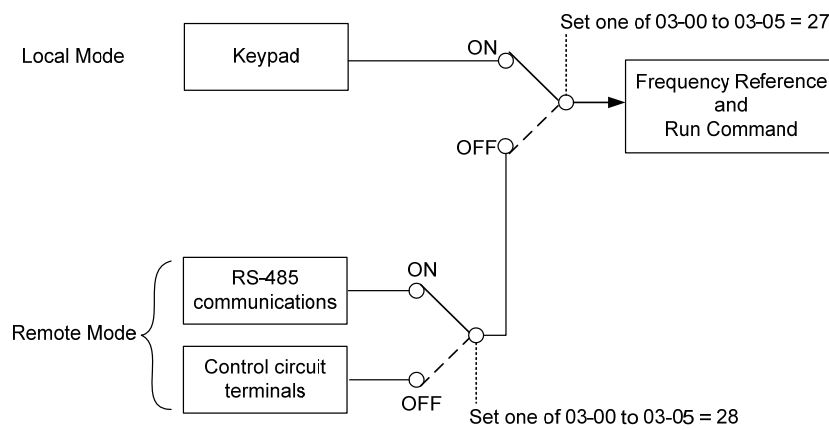

Figure 4.4.23 Remote mode operation selection

To switch the frequency reference and operation command input between communication RS-485 and control terminals the following parameters have to be set:

1. 00-05=1 (use control terminal AI1 or AI2 as reference frequency source)
2. 00-02=1 (use control terminal S1 or S2 for operation command)
3. Set one of the digital input terminals (03-02 to 03-05) to 28 (Operation selection of remote mode)

03-0X =29: Jog Frequency Selection

When jog frequency selection is on, the inverter will depend on the parameter 00-18 (jog frequency) as the command.

03-0X =30: Acceleration/ Deceleration Time Selection 2

When accel./ decel. time selection 2 is ON, the inverter will depend on the parameter 00-16 acceleration time 2 and the parameter 00-17 deceleration time 2.

03-0X =31: Inverter overheat warning

When input is active the inverter displays warning message "OH2" and continues operation. Deactivating the input reverts back to the original display. Warning message does not require resetting the inverter.

03-0X =32: Sync command

Selects between frequency reference source from pulse input or frequency reference source selected by parameter 00-05. Refer to page 4-116 for more information.

Input	Ref. Source	Frequency Reference / Run/Stop Command Source
ON	Pulse Input	- Frequency reference set by pulse input
OFF	Parameter 00-05	- Frequency reference source selected by parameter 00-05

Note:

- Function is disabled when the Local/Remote selection (25) or Remote mode selection (26) is active.
- To switch between local and remote the inverter has to be stopped.

03-0X =33: DC braking

When input is active DC-Injection braking is enabled during start and stopping of the inverter. DC Injection braking is disabled when a run or jog command is active. Refer to the DC braking time diagram in Figure 4.4.24.

Note: Short-circuit braking command or DC braking command can only be selected. If they are set simultaneously, SE02 error (DI Terminal Error) will occur.

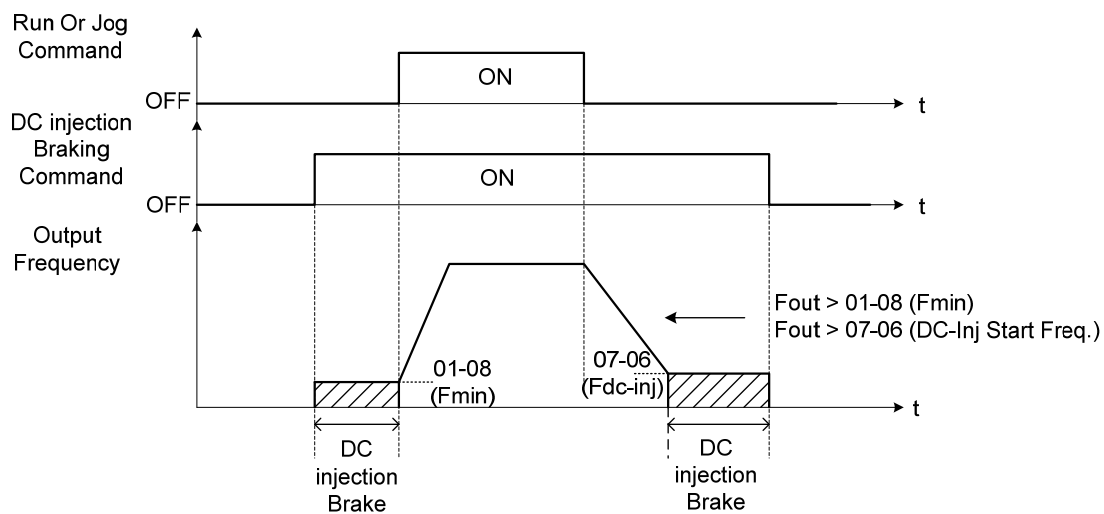

Figure 4.4.24 DC braking timing diagram

03-0X =35: Timing function

Refer to the "time function" parameter 03-37 and 03-38.

03-0X =36: PID Soft start disable

Refer to the "PID Control" function of PID function parameter group 10.

03-0X =37: Traverse operation

03-0X =38: Upper Deviation of traverse operation

03-0X =39: Lower Deviation of traverse operation
 See “Wobble Frequency” function in parameter group 19

03-0X =40: Switching between motor 1 and motor 2

03-0X =41: PID Sleep

Set parameter 10-29 to 2 (active by DI) and refer to the descriptions of parameters 10-17~10-20.

03-0X =47: Fire mode

When input is active disables all inverter warning and hardware protections. This function is commonly used in commercial applications where the inverter controls an exhaust fan and needs run to destruction in case of a fire.

03-0X =48: KEB acceleration

When input is active enables KEB (Kinetic Energy Braking) during acceleration. Refer to the parameter description of 11-47 and 11-48. Note: To enable set parameter 11-47 to a value greater than 0.

03-0X =49: Parameters write-in allowed

When input is active allows parameter to be changed.

Note: When none of the digital input terminals are set to function 49, parameter write-in protection is controlled by parameter 13-06.

Input	Parameter Save
ON	Parameters Write Enabled
OFF	Parameters Write Protected

03-0X =50: Unattended Start Protection (USP)

When input is active prevents inverter from starting automatically when a run command is present at time of power-up. Please refer to Figure 4.4.24a for more details.

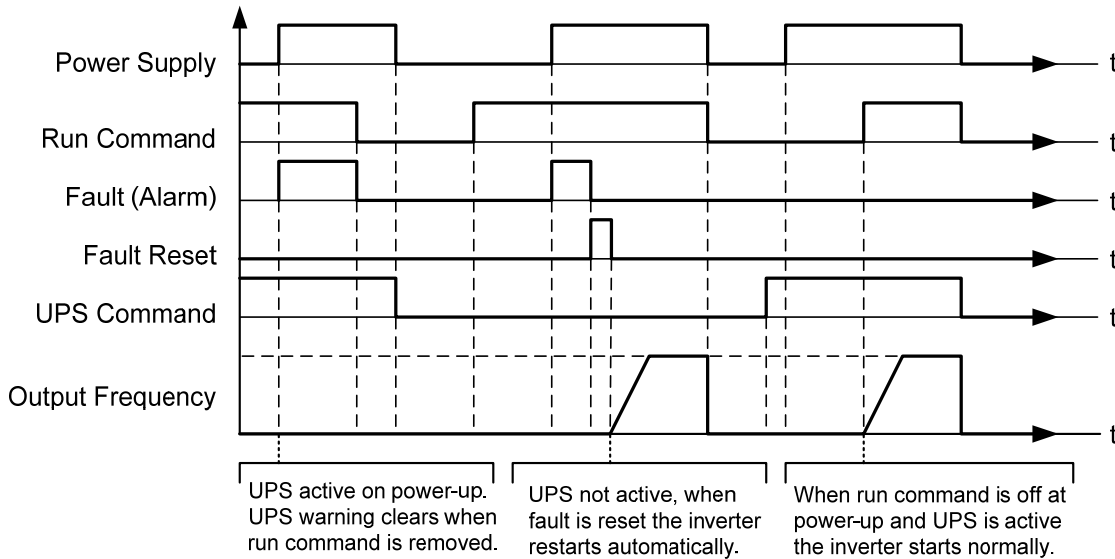

Figure 4.4.24a Unattended Start Protection

03-0X =53: 2-Wire Self-holding Mode (Stop Command)

Refer to parameter description of 00-02 (2-wire operation with self-holding function)

03-0X =58: Safety function

When safety function is on, the inverter will stop depending on the setting of 08-30 after the digital terminal is active.

03-0X =62: EPS function

EPS input is valid when low voltage activate. Please refer to page 4-84

03-08	(S1~S6) DI scan time
Range	0: scan time 4ms 1: scan time 8ms

Set the digital input CPU scan time. The digital input signal needs to be present for the minimum scan time to qualify as a valid command.

Note: For noisy environments select scan time of 8ms (results in a slower response time).

03-09	Multi-function terminal S1-S4 type selection
Range	xxx0b: S1 A contact xxx1b: S1 B contact xx0xb: S2 A contact xx1xb: S2 B contact x0xxb: S3 A contact x1xxb: S3 B contact 0xxxb: S4 A contact 1xxxb: S4 B contact

03-10	Multi-function terminal S5-S6 type selection
Range	xxx0b: S5 A contact xxx1b: S5 B contact xx0xb: S6 A contact xx1xb: S6 B contact

Parameter 03-09 and 03-10 selects the digital input type between a normally open and a normally closed

50: Frequency Detection 3 (\cong 03-44+03-45)
51: Frequency Detection 4 (\cong 03-44+03-45)
52: Frequency Detection 5 (\cong 03-46+03-47)
53: Frequency Detection 6 (\cong 03-46+03-47)
54~56: Reserved
57: Low Current Detection

Note: For frame 1, the DO2 function is setting by 03-12.

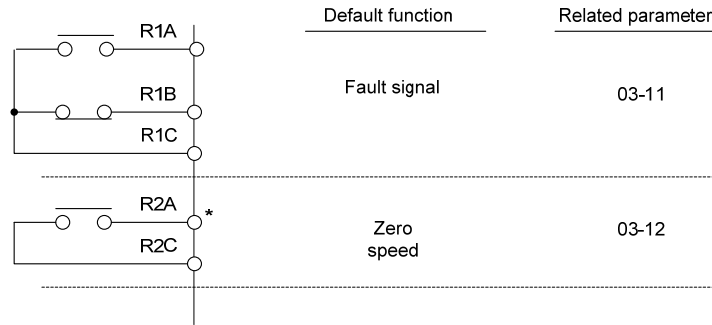

Figure 4.4.25 Multi-function digital output and related parameters

Table 4.4.29 Function table of multi-function digital output

Setting	Function Name	Contents	Control mode		
			V/F	SLV	SLV2
0	During Running	ON: During running (Run Command is ON)	0	0	0
1	Fault contact output	ON: Fault contact output (except CF00 and CF01)	0	0	0
2	Frequency agree	ON: frequency agree (frequency agree width detection is set by 03-14)	0	0	0
3	Setting frequency agree	ON: Output frequency = allowed frequency detection level (03-13) \pm frequency bandwidth (03-14)	0	0	0
4	Frequency detection 1 (> 03-13)	ON: Output frequency > 03-13 Hysteresis range is 03-14	0	0	0
5	Frequency detection 2 (< 03-13)	OFF: Output frequency > 03-13. Hysteresis range is 03-14	0	0	0
6	Automatic restart	ON: the period of automatic restart	0	0	0
7	Reserved	Reserved	-	-	-
8	Reserved	Reserved	-	-	-
9	Baseblock	ON: During baseblock	0	0	0
10	Reserved	Reserved	-	-	-
11	Reserved	Reserved	-	-	-
12	Over-Torque Detection	ON: Over torque detection is ON	0	0	0
13	Current Agree	ON: when output current > 03-15 is ON	0	0	0
14	Mechanical Braking Control (03-17~18)	ON: Mechanical braking release frequency OFF: Mechanical braking run frequency	0	0	0
15	Reserved	Reserved	-	-	-
16	Reserved	Reserved	-	-	-
17	Reserved	Reserved	-	-	-

Setting	Function Name	Contents	Control mode		
			V/F	SLV	SLV2
18	Reserved	Reserved	-	-	-
19	Reserved	Reserved	-	-	-
20	Zero speed	ON: Output frequency < Minimum output frequency (Fmin)	0	0	0
21	Inverter Ready	ON: Inverter ready (after power on, no faults)	0	0	0
22	Undervoltage Detection	ON: DC bus voltage = < Low-voltage warning detection level (07-13)	0	0	0
23	Source of operation command	ON: operation command from LED digital operator (local mode)	0	0	0
24	Source of reference command	ON: reference frequency from LED digital operator (local mode)	0	0	0
25	Low torque detected	ON: Low-torque detection is ON	0	0	0
26	Frequency reference missing	ON: Reference frequency loss	0	0	0
27	Timing function output	Set time function parameter to 03-33 and 03-34 , and the time function input is set by parameter from 03-00 and 03-05	0	0	0
28	Traverse operation UP Status	ON: in acceleration period (when the wobbling is in operating)	0	X	0
29	During Traverse operation status	ON: In the period of frequency wobbling operation (when the wobbling is in operating)	0	X	0
30	Select motor 2	ON: Switch to motor 2	0	0	0
31	Reserved	Reserved	-	-	-
32	Communication control contacts	ON: Communication control contacts (location:2507H).	0	0	0
33	Reserved	Reserved	-	-	-
34	Reserved	Reserved	-	-	-
35	Reserved	Reserved	-	-	-
36	Reserved	Reserved	-	-	-
37	PID Feedback Loss Detection Output	ON: PID Feedback Loss	0	0	0
38	Break Release	ON: Release Brake	X	0	X
39	Frequency Detection 1 (dedicated for Crane)	ON: Output frequency > 03-13, Hysteresis range : 03-14	0	0	X
40	Reserved	Reserved	-	-	-
42	Reserved	Reserved	-	-	-
43	Reserved	Reserved	-	-	-
44	Reserved	Reserved	-	-	-
45	PID sleep	ON: During PID Sleep	0	X	X
46	Reserved	Reserved	-	-	-
47	Reserved	Reserved	-	-	-
48	Reserved	Reserved	-	-	-
49	Reserved	Reserved	-	-	-
50	Frequency Detection 3	ON: output frequency > 03-44, Hysteresis range :03-45	0	0	0
51	Frequency Detection 4	OFF: output frequency > 03-44, Hysteresis range :03-45	0	0	0

Setting	Function	Contents	Control mode		
	Name		V/F	SLV	SLV2
52	Frequency Detection 5	ON: output frequency > 03-46, Hysteresis range :03-47	○	○	○
53	Frequency Detection 6	OFF: output frequency > 03-46, Hysteresis range :03-47	○	○	○
54	Reserved	Reserved	-	-	-
57	Low Current Detection	ON: Output Current \leq 03-48 Low current detection level	○	○	○

03-1X=0: During Running

OFF	Run command is OFF and the inverter is stopped.
ON	Run command is ON or output frequency is greater than 0.

03-1X=1: Fault contact output

Output is active during fault condition.

Note: Communication error (CF00, CF01) do not activate the fault contact.

03-1X=2: Frequency Agree

Output is active when the output frequency falls within the frequency reference minus the frequency detection width (03-14).

03-1X=3: Setting Frequency Agree

Output is active when the output frequency falls within the frequency detection width (03-14) of the set frequency detection level (03-13).

03-1X=4: Frequency detection 1

Output is active when the output frequency rises above the frequency detection level (03-13) + frequency detection width (03-14) and deactivates when the output frequency falls below frequency detection level (03-13).

03-1X=5: Frequency detection 2

Output is active when the output frequency is below the frequency detection level (03-13) + frequency detection width (03-14) and turns off when the output frequency falls below frequency detection level.

Refer to table 4.4.30 for the operation of frequency detection.

03-1X=6: Automatic restart.

Output is active during an auto-restart operation.

03-1X=9: Baseblock (B.B.)

Output is active when the inverter output is turned off during a Baseblock command.

03-1X=12: Over torque detected (Normally Open)

Output is active during an over torque detection see parameters 08-13 ~ 08-16.

03-1X=25: Low torque detected (Normally Open)

Output is active during low torque detection see parameters 08-17 ~ 08-20.

03-1X=13: Current Agree

When output current > 03-15 and output current > 03-15 duration >03-16, it is ON.

03-1X=20: Zero-speed

Output is active during zero-speed

Active	Output frequency \leq minimum output frequency (01-08, Fmin)
Off	Output frequency \geq the minimum output frequency

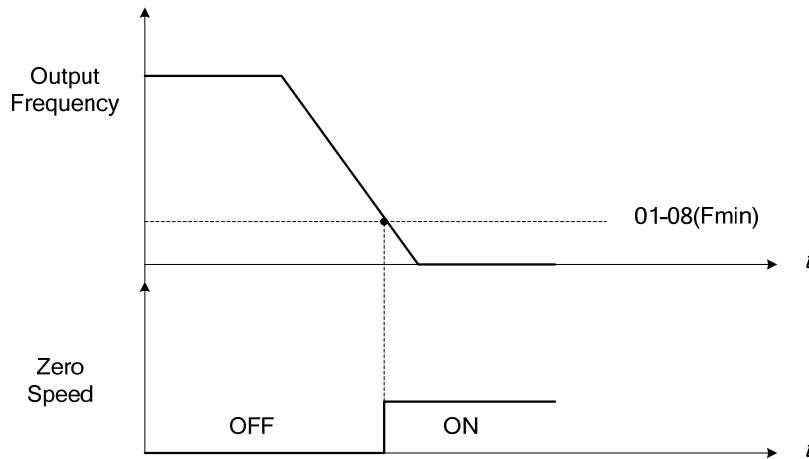

Figure 4.4.26 Zero-speed operation

03-1X=21: Inverter Ready

Output is active when no faults are active and the inverter is ready for operation.

03-1X=22: Under voltage Detection

Output is active when the DC bus voltage falls below the low voltage detection level (07-13).

03-1X=23: Source of operation command

Output is active in local operation command.

OFF	Remote mode: 00-02 = 1 or 2, or any one of the multi-function digital input terminals (S1 to S6) set to function 5 (LOCAL / REMOTE control) is OFF.
ON	Local mode: 00-02 = 0, or any one of the multi-function digital input terminals (S1 to S6) set to function 5 (LOCAL / REMOTE control) is active.

03-1X=24: Source of frequency command

Output is active in local frequency command.

OFF	Remote mode: 00-05 = 1 or 2, or any one of the multi-function digital input terminals (S1 to S6) set to function 5 (LOCAL / REMOTE control) is OFF.
ON	Local mode: 00-05 = 0, or any one of the multi-function digital input terminals (S1 to S6) set to function 5 (LOCAL / REMOTE control) is active.

03-1X=26: Frequency reference missing

Output is active when the frequency reference is lost. When parameter 11-41 is set to 0 the inverter will decelerate to a stop. When parameter 11-41 is set to 1 operation will continue at the value of parameter 11-42 times the last know frequency reference.

03-1X=27: Time function output

Output is controlled by timer function see parameter 03-37 and 03-38.

03-1X=28: Traverse operation UP status

Output is controlled by frequency wobbling operation; refer to Parameter group 19 for details.

03-1X=29: During Traverse operation status

Output is controlled by the acceleration period or frequency wobbling operation, refer to Parameter group 19 for details.

03-1X=30: Motor 2 selected

Output is active when motor 2 is selected.

03-1X=32: Communication control contacts

Communication location: 2507H, control by RY2 RY1.

03-1X=37: PID Feedback Loss Detection Output

When PID feedback loss occurs (refer to the setting of parameters 10-11~10-13), it performs the state of ON.

03-1X=38: Brake Release

The state of ON means release brake is active. Refer to parameters 03-41~03-42 for the details.

03-1X=39: Frequency Detection 1 (dedicated for Crane)

03-1X=45: PID Sleep

It will inform when PID sleep ON.

03-1X=50: Frequency Detection 3

Please refer to Table 4.4.9 Frequency detection operation

03-1X=51: Frequency Detection 4

Please refer to Table 4.4.9 Frequency detection operation

03-1X=52: Frequency Detection 5

Please refer to Table 4.4.9 Frequency detection operation

03-1X=53: Frequency Detection 6

Please refer to Table 4.4.9 Frequency detection operation

03-1X=54: Turn on short-circuit braking

Output terminal is closed when Turning on short-circuit braking

03-1X=57: Low Current Detection

When output current \leq 03-48, relay is active.

03-13	Frequency detection Level
Set Range	0.0~599.0 Hz

03-14	Frequency detection width
Range	0.1~25.5 Hz

Frequency detection Level: set the multi-function output terminals R1A-R1C, R2A-R2C or PH1 (03-11, 03-12 or 03-28) to the desired detection level and bandwidth for use with multi-function output functions 2 to 5.

The time charts for the Frequency Agree Detection operation are shown in the following table 4.4.9.

03-44	Frequency Detection Level 2
Range	0.0~599.0 Hz

03-45	Frequency Detection Width 2
Range	0.1~25.5 Hz

03-46	Frequency Detection Level 3
Range	0.0~599.0 Hz

03-47	Frequency Detection Width 3
Range	0.1~25.5 Hz

03-50	Frequency Detection Level 4
Range	0.0~599.0 Hz

03-51	Frequency Detection Level 5
Range	0.0~599.0 Hz

03-52	Frequency Detection Level 6
Range	0.0~599.0 Hz

Frequency Detection : Set R1A-R1C , R2A-R2C or PH1 (03-11, 03-12 or 03-28) to output frequency signal and then set frequency confirmation and output frequency detection 1~6.
Please refer to table 4.4.30.detection operation of frequency time block

Table 4.4.30 Frequency detection operation

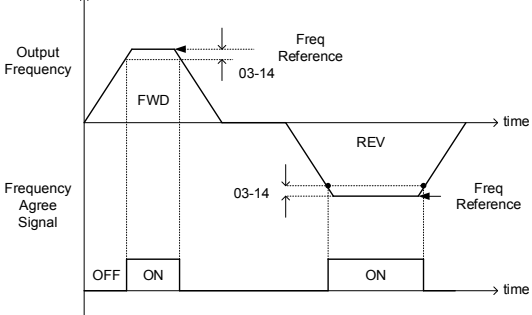
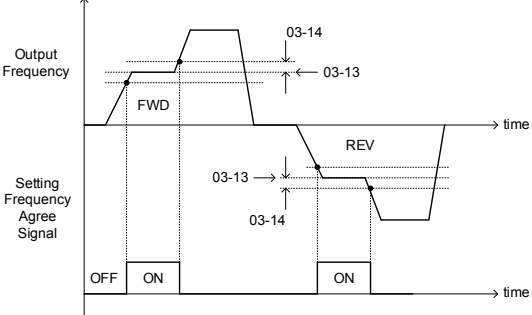
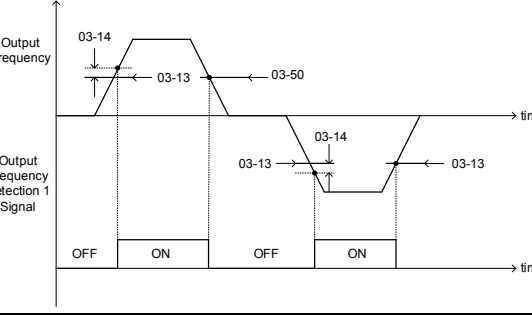
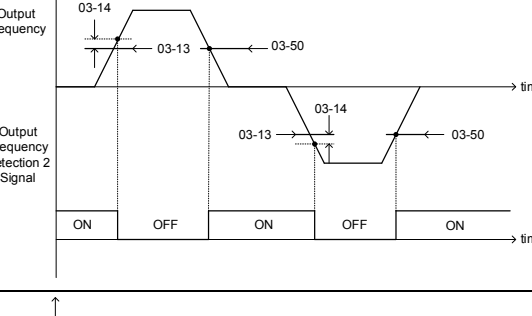
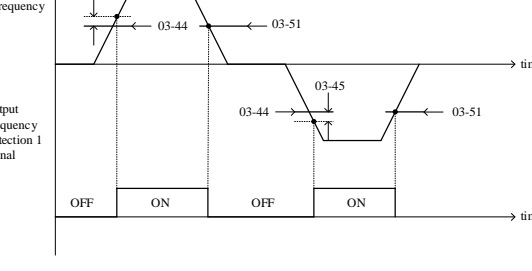
Function	Detection operation of frequency confirmation	Description
Frequency agree		<p>Output is active when the output frequency falls within the frequency reference minus the frequency detection width (03-14).</p> <p>Any of the digital outputs function (03-11, 03-12 or 03-28) can be set to 2 (Frequency agree).</p>
Set frequency agree		<p>Output is active the output frequency falls within the frequency detection width (03-14) of the set frequency detection level (03-13).</p> <p>Any of the digital outputs function (03-11, 03-12 or 03-28) can be set to 3 (Set frequency agree).</p>
Output frequency detection 1		<p>Output is active when the output frequency rises above the frequency detection level (03-13) + frequency detection width (03-14) and deactivates when the output frequency falls below frequency detection level 4 (03-50).</p> <p>Any of the digital outputs function (03-11, 03-12 or 03-28) can be set to 4 (Output frequency detection 1).</p>
Output frequency detection 2		<p>Output signal is OFF when the output frequency rises above the frequency detection level (03-13) + frequency detection width (03-14) and turns ON when the output frequency falls below the frequency detection level 4 (03-50).</p> <p>Any of the digital outputs function (03-11, 03-12 or 03-28) can be set to 5 (Output frequency detection 2).</p>
Output frequency detection 3		<p>Output is active when the output frequency rises above the frequency detection level 2 (03-44) + frequency detection width 2 (03-45) and deactivates when the output frequency falls below frequency detection level 5(03-51).</p> <p>Any of the digital outputs function (03-11, 03-12 or 03-28) can be set to 50 (Output frequency detection 3).</p>

Function	Detection operation of frequency confirmation	Description
Output frequency detection 4		<p>Output signal is OFF when the output frequency rises above the frequency detection level 2 (03-44) + frequency detection width 2 (03-45) and turns ON when the output frequency falls below frequency detection level 5 (03-51).</p> <p>Any of the digital outputs function (03-11, 03-12 or 03-28) can be set to 51 (Output frequency detection 4).</p>
Output frequency detection 5		<p>Output is active when the output frequency rises above the frequency detection level 3 (03-46) + frequency detection width 3 (03-47) and deactivates when the output frequency falls below frequency detection level 6 (3-52).</p> <p>Any of the digital outputs function (03-11, 03-12 or 03-28) can be set to 52 (Output frequency detection 5).</p>
Output frequency detection 6		<p>Output signal is OFF when the output frequency rises above the frequency detection level 3 (03-46) + frequency detection width 3 (03-47) and turns ON when the output frequency falls below frequency detection level 6 (3-52).</p> <p>Any of the digital outputs function (03-11, 03-12 or 03-28) can be set to 53 (Output frequency detection 6).</p>
Output Frequency Detection 1 (dedicated for Crane)		<p>If the output frequency > frequency detection level (03-13) + frequency detection width (03-14) during acceleration, signal of output frequency detection 1 (dedicated for Crane) is ON.</p> <p>If the output frequency < frequency detection level 4 (03-50) during deceleration, signal of output frequency detection 1 (dedicated for Crane) is OFF.</p> <p>Set any parameters 03-11, 03-12 or 03-28 to 39 (output frequency detection – dedicated for Crane).</p>
Frequency Output		<p>When the inverter output frequency is active, the output terminal is closed.</p>

03-15	Current Agree Level
Range	0.1~999.9 A
03-16	Delay Time of Current Agree Detection
Range	0.1~10.0 Sec

03-11=13, then,

When the output current >03-15, relay is active.

03-15: The suggested setting value is 0.1~ the motor rated current.

03-16: The delay time performs depending on the setting value.

Note: Delay time from ON to OFF in the signal of relay is 100ms (constant).

Time Diagram:

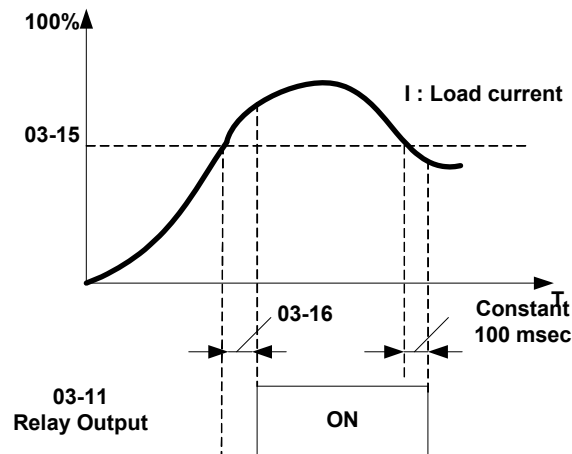

03-48	Low Current Detection Level
Range	【0.0~999.9】 A
03-49	Low Current Detection Delay Time
Range	【0.00~655.35】 Sec

03-11 set to 57: When output current \leq 03-48 (Low current detection level), the relay works.
 When 03-48 set 0.0, low current detection function disabled.
 If the detection time is bigger than the setting time of 03-49, the relay works.
 Besides, the relay delay time from ON to OFF is 100ms, and it's fixed.

The timing chart:

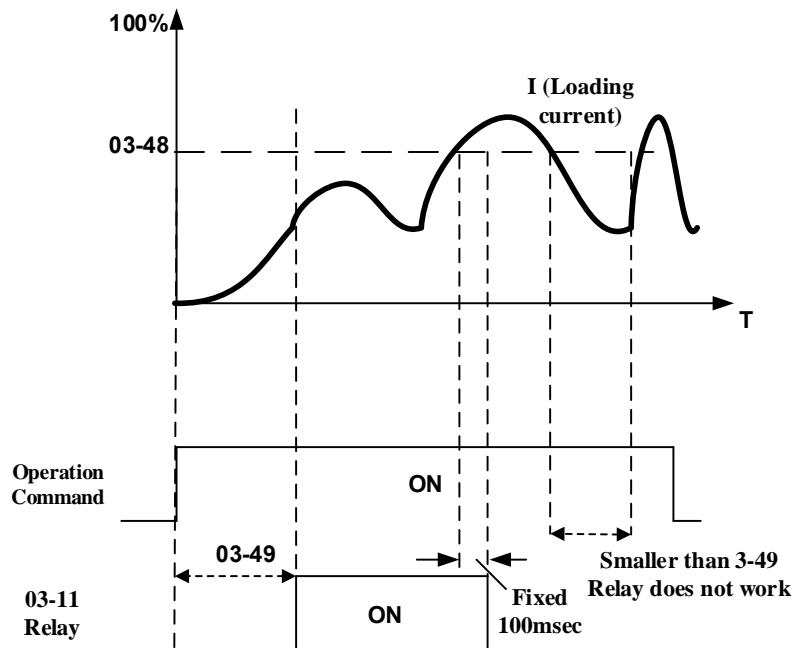

03-17	Mechanical Braking Release Level
Range	0.00~599 Hz

03-18	Mechanical Braking Level Set
Range	0.00~599 Hz

When 03-11=14, the real frequency equal to the value of 03-17 (Mechanical Braking Release Level) in acceleration time, the relay output will execute.
 When 03-11=14, the real frequency equal to the value of 03-18 (Mechanical Braking Level Set) in deceleration time, the relay output will stop execute.

03-17 ≤ 03-18 · the following is the time sequence:

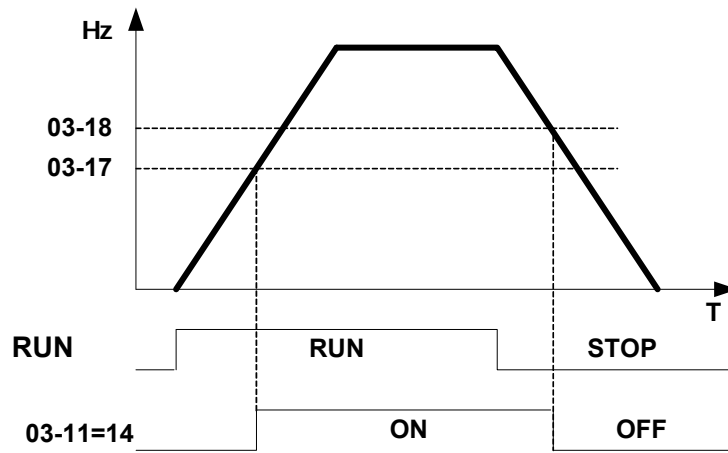

03-17 ≥ 03-18 · the following is the time sequence:

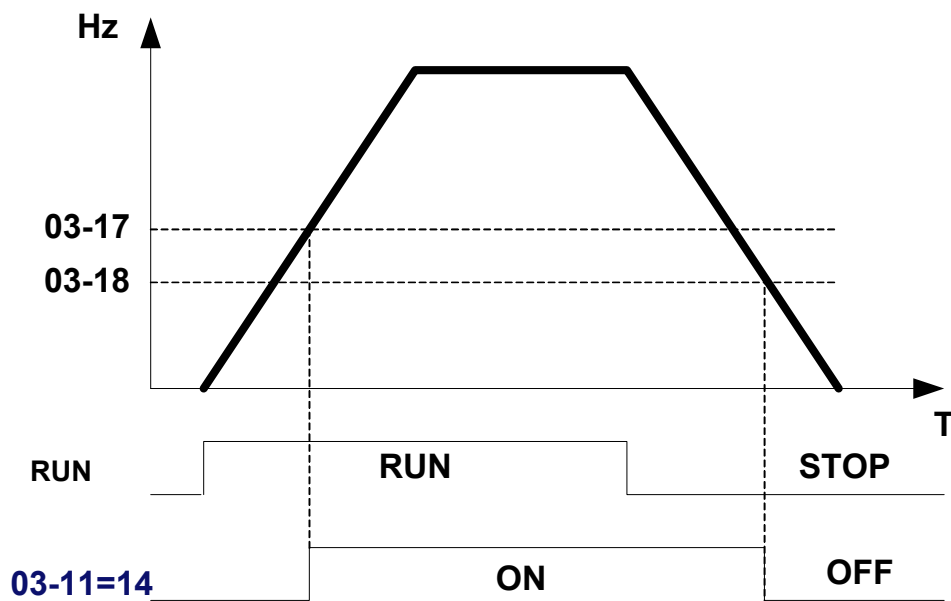

03-19	Relay (R1A-R2C) type
Range	xxx0b: R1 A contact xxx1b: R1 B contact
	xx0xb: R2 A contact xx1xb: R2 B contact

Parameter 03-19 selects the digital output type between a normally open and a normally closed contact.

Each bit of 03-19 presents an output :

03-19= 0 0 0: normally open contact

R2 R1 1: normally close contact

Example: R1 normally open and R2 normally closed contact set 03-19=xxx01.

03-27	UP/DOWN Frequency Hold/Adjust Selection
Range	0: Hold last set frequency when stopped
	1: Set frequency to 0 when stopped
	2: Allow speed changes from last set frequency when stopped
	3: Refresh frequency at acceleration

03-27=0: When the run command is removed the UP/DOWN frequency reference before deceleration is stored. The next time the run command is applied the output frequency will ramp up to the previously stored frequency reference.

03-27=1: When the run command is removed the UP/DOWN frequency reference command is cleared (set to 0). The next time the run command is applied the output frequency will start at 0.

03-27=2: UP/DOWN command is active when run command is not active.

03-27=3:

Keep the state of frequency command not to be cleared. When run command re-sends, press UP/DOWN key before the run frequency reaches the frequency command.

03-40	Up/Down Frequency Width Setting
Range	0.00~5.00 Hz

When 03-40 is set to 0 Hz, Up / Down function is maintained.

When 03-40 is not set to 0 Hz, frequency command is set by the run frequency plus the setting frequency of 03-40.

Example: set terminal S1: 03-00=8 (Up increased frequency command), terminal S2: 03-01=9 (Down decreased frequency command) and 03-40= Δ Hz.

Mode 1: When 03-40 is set to 0 Hz, Up / Down function is maintained. Refer to Fig. 4.4.20.

Mode 2: When 03-40 is not set to 0 Hz and terminals conduction time < 2 Sec, frequency change (Δ Hz) at one conduction occurs depending on the setting of 03-40.

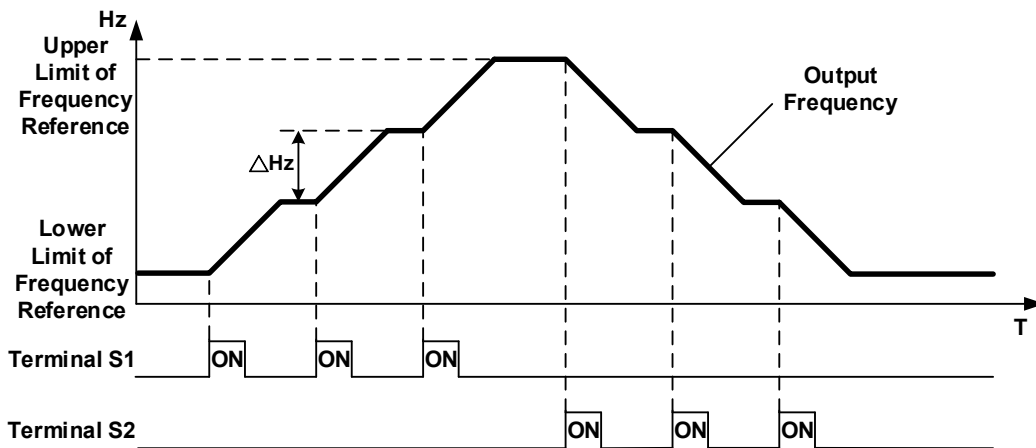

Mode 3: When 03-40 is not set to 0 Hz and terminals conduction time > 2 Sec, frequency changes upon general acceleration/ deceleration.

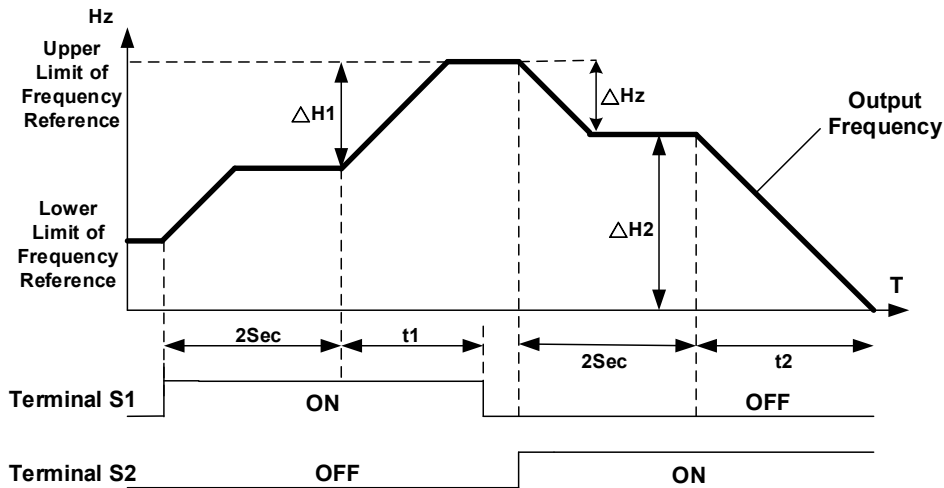

※Descriptions:

$\Delta H1$: frequency increment setting at acceleration, $t1$: terminal conduction time at acceleration,
 $\Delta H2$: frequency increment setting at deceleration, $t2$: terminal conduction time at deceleration.

$$\Delta H1 = \frac{\text{Upper Limit Frequency}}{\text{Acceleration Time 2}} \times \text{Terminal Conduction Time (t1)}$$

$$\Delta H2 = \frac{\text{Upper Limit Frequency}}{\text{Deceleration Time 2}} \times \text{Terminal Conduction Time (t2)}$$

03-28	Photo-coupler Output
Range	See function selection list parameter 03-11

03-29	Photo-coupler Output Selection
Range	xxx0b: Photo-coupler A Contact xxx1b: Photo-coupler B Contact

0 = Normally open (A), 1 = Normally closed (B)

03- 30	Function setting of pulse input
Range	0: General Pulse Input 1: PWM

There are two ways for pulse input selection:

(1) General pulse input:

PI= cutoff frequency divided by pulse input scale set by 03-31, corresponding to the maximum output frequency of motor 1 (01-02).

Monitoring parameter 12-79 (pulse input percentage) is the proportional relationship between input signal and pulse input scale of 03-31.

(2) PWM: It is required to input the correct frequency.

PWM= Time of positive edge pulse divided by the time period of pulse, corresponding to the maximum output frequency of motor 1 (01-02).

Monitoring parameter 12-79 (pulse input percentage) is the proportional relationship between the positive edge terminal of input signal and time period.

Note: Deviation of pulse time period in PWM is $\pm 12.5\%$. If it is over the deviation range, pulse input is not active.

Diagram for pulse input selection:

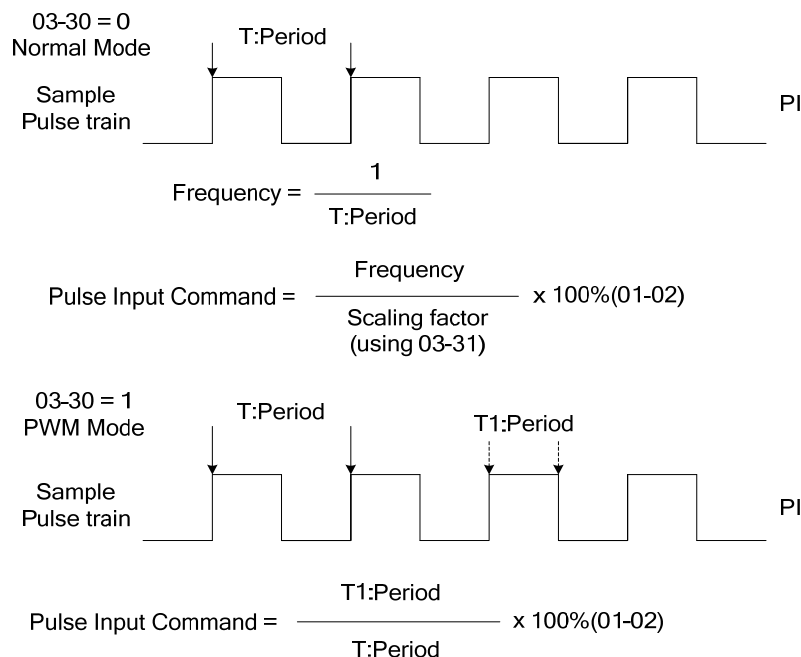

03-31	Scale of pulse input
Range	Depending on the setting of 03-30 03-30=0: 50~32000Hz 03-30=1: 10~1000Hz

Pulse input scaling, 100% = Maximum pulse frequency.

03-32	Pulse input gain
Range	0.0~1000.0 %

Target value (03-03) in % = Pulse input frequency scaled to 100% based on maximum pulse frequency (03-31) times the gain (03-32) + bias (03-33).

03-33	Pulse input bias
Range	-100.0~100.0 %

Target value (03-03) in % = Pulse input frequency scaled to 100% based on maximum pulse frequency (03-31) times the gain (03-32) + bias (03-33).

03-34	Pulse input filter time
Range	0.00~2.00 Sec

* Refer to section 3.9 control circuit terminals for details.

* Refer to figure 4.4.27 for the pulse input specification.

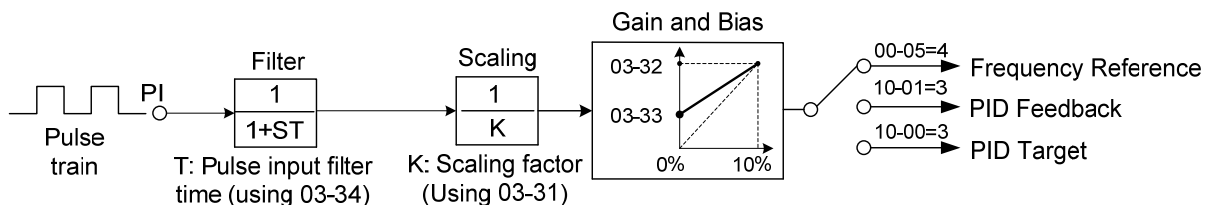

Figure 4.4.27 Pulse input adjustment

Set Pulse Input Setup as Frequency Reference

Set parameter 00-05 to 4 and 03-30 to 0 to use the pulse input terminal PI as the frequency reference source. Refer to Figure 4.3.5. for details. Next set the pulse input scaling (03-31), enter the pulse input frequency to match the maximum output frequency. Adjust the pulse input filter time in case interference or noise is encountered.

Example: Pulse train input maximum 10 kHz, set parameter 03-31 to 10000 when maximum frequency is set to 60.0Hz.

Set Pulse Input as PID feedback value

Set parameter 00-05 to 5, 03-30 to 1 and PID feedback value source 10-01 to 3, to use the pulse input terminal PI as the PID target (setpoint) value. Next set the pulse input scaling (03-31), enter the pulse input frequency to match the maximum output frequency. Adjust the pulse input filter time in case interference or noise is encountered. Refer to Figure 4.4.28. for details.

Note: The inverter will display a SE09 "PI setting error" when 03-30 = 1 and 10-01 is not set to 3.

Set Pulse Input as PID target value

Set parameter 00-05 to 5 and 03-30 to 2 to use the pulse input terminal PI as the PID target (setpoint) value. Next set the pulse input scaling (03-31), enter the pulse input frequency to match the maximum output frequency. Adjust the pulse input filter time in case interference or noise is encountered. Refer to Figure 4.4.28. for details.

Note: The inverter will display a SE09 "PI setting error" if 03-30=0 and PID control is enabled (10-03 > 0).

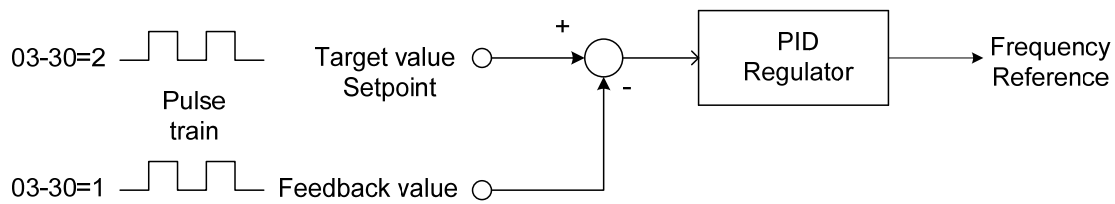

Figure 4.4.28 PID control

03-35	Function setting of pulse output
Range	1: Frequency command 2: Output frequency 3: Output frequency after the soft start 4: Motor speed 5: PID feedback 6: PID input 7: Reserved

Refer to Table 4.4.10 for pulse output function selection overview.

03-36	Scale of pulse output
Range	1~32000 Hz

Pulse output scaling, 100% = Maximum pulse frequency (see table 4.4.10).

Note: When setting 03-35 to 2 (output frequency) and setting 03-36 to 0 (0 Hz), PO's pulse output and the inverter output frequency are sync.

Table 4.4.31 Pulse output function selection

03-35	Function	Parameter	100%
1	Frequency command	12-16	01-02
2	Output frequency (Fout)	12-17	01-02
3	Output frequency after soft-start	-	01-02
4	Motor speed (rpm)	12-22	01-02
5	PID feedback	12-39	01-02
6	PID input	12-36	01-02

Note: Selection 1~4 are related to the motor speed, 5 and 6 are related to PID.

Setup the pulse output

Use 03-36 (pulse output scale) to set the pulse output frequency to 100% signal value of the selected item.

Please refer to the figure 4.4.29.

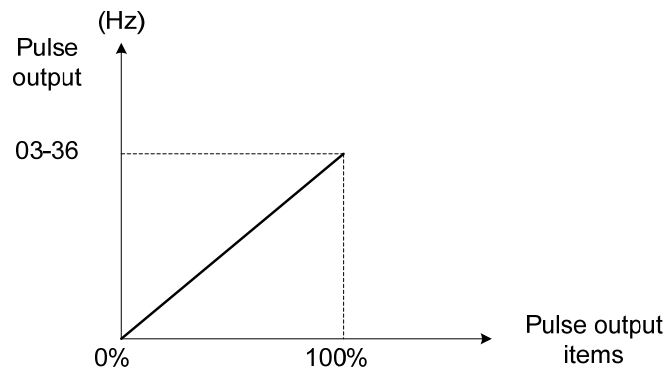

Figure 4.4.29 Pulse output proportion

When setting 03-35 to 2 (output frequency), PO's pulse output and the inverter output frequency are sync. Scale of pulse output is equal to the value of 03-36.

For the pulse output signal level, please refer to figure 4.4.30.

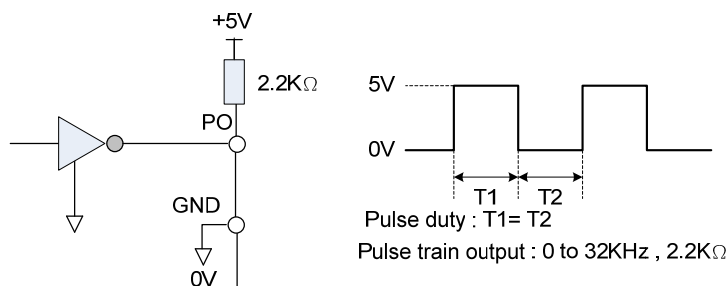

Figure 4.4.30 Pulse output signal level

Note: When pulse output function is active, it is required to use the external pull-up resistor at the terminal of PO (the upper limit current of PO is 50mA and 48V)

Application examples

Example A: Speed follower from external PG

Use the pulse input signal as frequency reference or synchronization operation. Refer to Fig. 4.4.31.

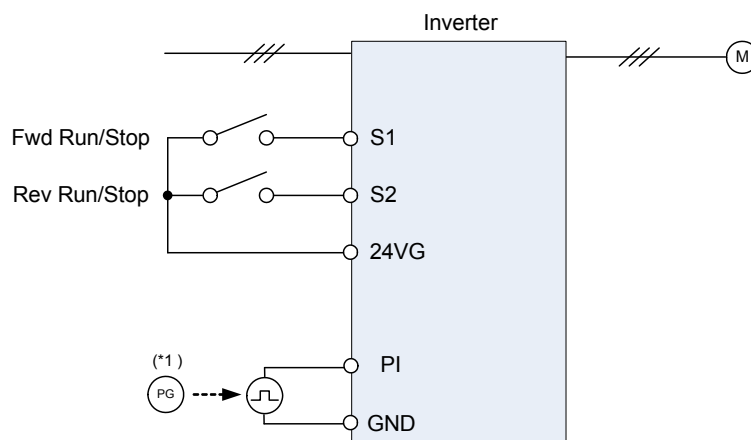

Figure 4.4.31 Speed follower from external PG

Parameter settings:

1. Frequency reference selection: 00-05=4 (Pulse input)
2. Pulse input's function selection: 03-30=0 (General pulse input)
3. Pulse input scale: 03-31 (set the number of pulse in Hz to match maximum output frequency, 01-02)
4. Pulse input gain: 03-32 (Set the input gain of the pulse frequency set by 03-31)
5. Pulse input bias: 03-33 (Set the input bias of the pulse frequency set by 03-31)
6. Pulse input's filter time: 03-34 (if the pulse input is unstable due to the interference, increase value.)

Use the forward and reverse multi-function inputs to choose motor direction.

Example B: Speed follower using two inverters

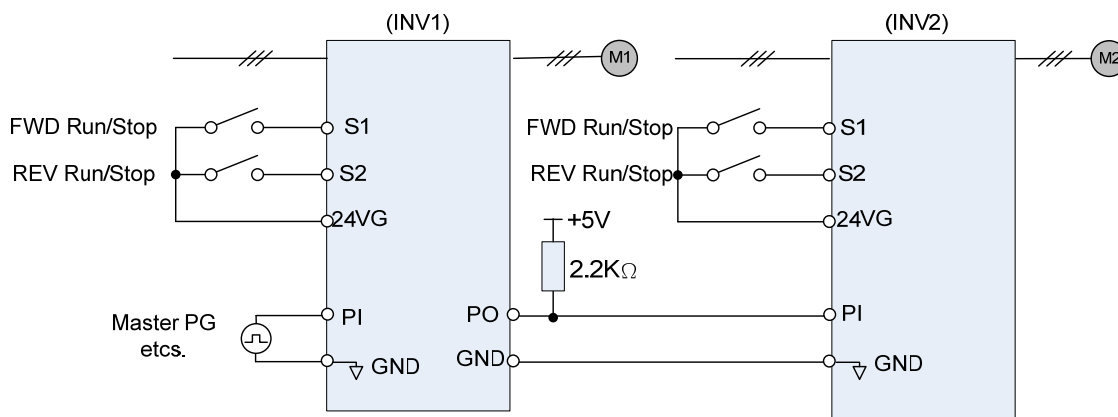

Figure 4.4.32 Speed follower using two inverters

Inverter #1 parameter settings: Frequency reference from PI signal (Master PG)

1. Frequency reference selection: 00-05=4 (Pulse input)
2. Pulse input's function selection: 03-30=0 (General pulse input)
3. Pulse input scale: 03-31 (set the number of pulse in Hz to match maximum output frequency, 01-02)
4. Pulse input gain: 03-32 (Set the input gain of the pulse frequency set by 03-31)
5. Pulse input bias: 03-33 (Set the input bias of the pulse frequency set by 03-31)
6. Pulse input's filter time: 03-34 (if the pulse input is unstable due to the interference, increase value.)
7. Pulse output function selection: 03-35=2 (Pulse output is output frequency)
8. Scale pulse output parameter 03-36 to 100% of output frequency

Inverter #1 parameter settings: Frequency reference from analog signal

1. Frequency reference selection: 00-05=1 (Analog input)
2. Pulse output function selection: 03-35=2 (Pulse output is output frequency)
3. Scale pulse output parameter 03-36 to 100% of output frequency

Inverter #2: parameter settings:

1. Frequency reference selection: 00-05=4 (Pulse input)
2. Pulse input's function selection: 03-30=0 (General pulse input)
3. Pulse input scale: 03-31 (set the number of pulse in Hz to match maximum output frequency, 01-02)
4. Pulse input gain: 03-32 (Set the input gain of the pulse frequency set by 03-31)
5. Pulse input bias: 03-33 (Set the input bias of the pulse frequency set by 03-31)
6. Pulse input's filter time: 03-34 (if the pulse input is unstable due to the interference, increase value.)

Note: When pulse output function is active, it is required to use the external pull-up resistor at the terminal of PO (the upper limit current of PO is 50mA)

Example C: Synchronized operation using pulse input

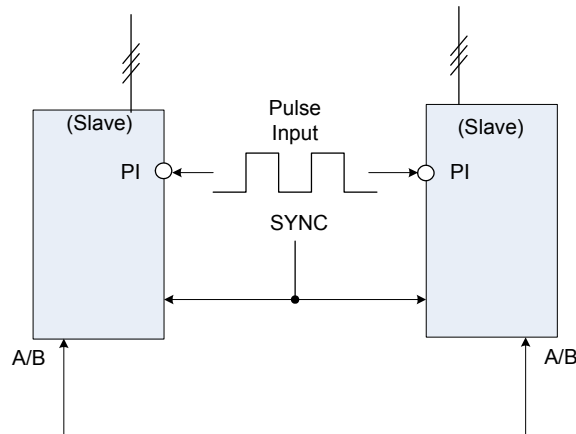

(Synchronized Operation)

Figure 4.4.33: Synchronized operation of using pulse input

Connect pulse signal of an external pulse generator to the pulse input terminal PI of multiple follower inverters for output speed synchronization.

Follow inverter #1 and Follower #2 parameter settings:

1. Frequency reference selection: 00-05=4 (Pulse input)
2. Pulse input's function selection: 03-30=0 (General pulse input)
3. Set one of the Multi-function inputs Sn: 03-00 ~ 03-05=32 (Synchronization command)

Example D: Synchronized operation of using pulse output master follower

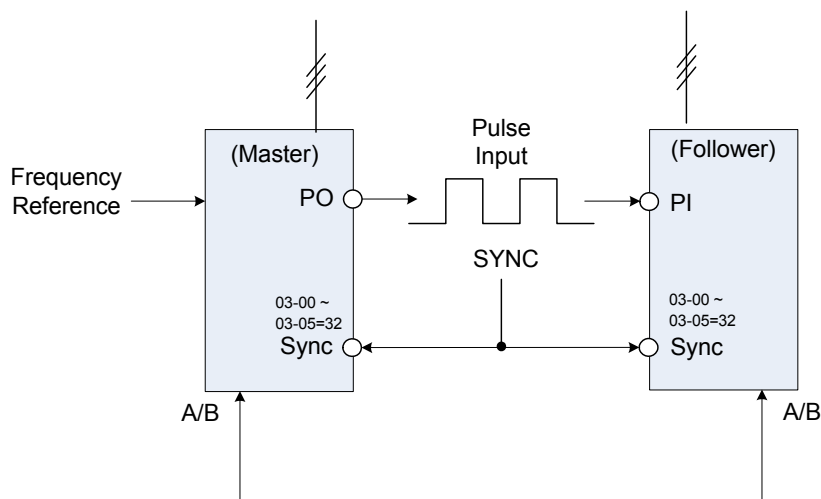

(Synchronized Operation)

Figure 4.4.34 Synchronized operation master follower

Master inverter parameter settings:

1. Pulse output function selection: 03-35=1 (Pulse output is output frequency)
2. Scale pulse output parameter 03-36 to 100% of output frequency
3. Set one of the Multi-function inputs Sn: 03-00 ~ 03-05=32 (Synchronization command)

Follower inverter parameter settings:

1. Frequency reference selection: 00-05=4 (Pulse input)
2. Pulse input's function selection: 03-30=0 (Frequency command)
3. Pulse input scale: 03-31 (set the number of pulse in Hz to match maximum output frequency, 01-02)
4. Pulse input gain: 03-32 (Set the input gain of the pulse frequency set by 03-31)
5. Pulse input bias: 03-33 (Set the input bias of the pulse frequency set by 03-31)
6. Pulse input's filter time: 03-34 (if the pulse input is unstable due to the interference, increase value.)
7. Set one of the Multi-function inputs Sn: 03-00 ~ 03-05=32 (Synchronization command)

03-37	Timer ON delay (DIO)
Range	0.0~6000.0 Sec

03-38	Timer OFF delay (DIO)
Range	0.0~6000.0 Sec

Enable the timer function by setting one of multi-function input parameters 03-00~03-05 (S1 to S6) to 35 (timer function input) and one of multi-function output parameters 03-11, 03-12 (R1A-R1C to R2A- R2C and DO1) to 27 (timer function output).

The timer function can be used to implement a timer relay. Use timing parameter 03-37 and 03-38 to set the timer ON / OFF delay.

Timer output is turned ON when the multi-function timer input is ON for the time specified in parameter 03-37.

Timer output is turned OFF after the multi-function timer input is turned OFF for the time specified in parameter 03-38.

Timing example:

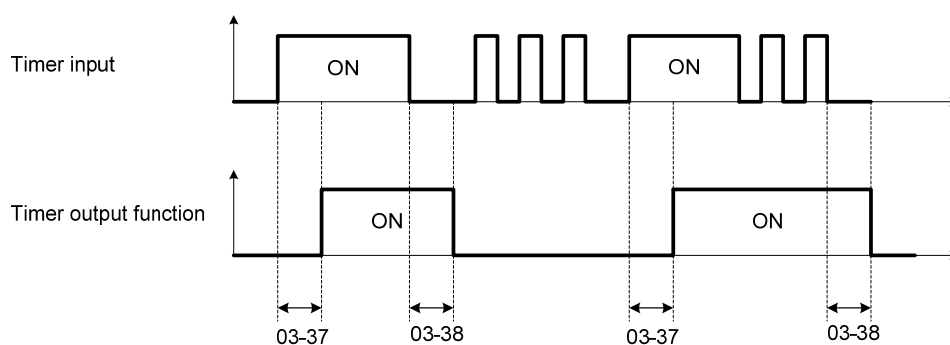

03-41	Torque Detection Level
Range	0~150 %
03-42	Brake Release Delay Time
Range	0.00~65.00 Sec

Brake Release Function:

It is required to be with the frequency agree function, as the following figure:

When the inverter starts running, if the output frequency > 03-13, and both frequency detection level and output torque > torque detection level (03-41), it will delay the time of 03-42 to release brake.

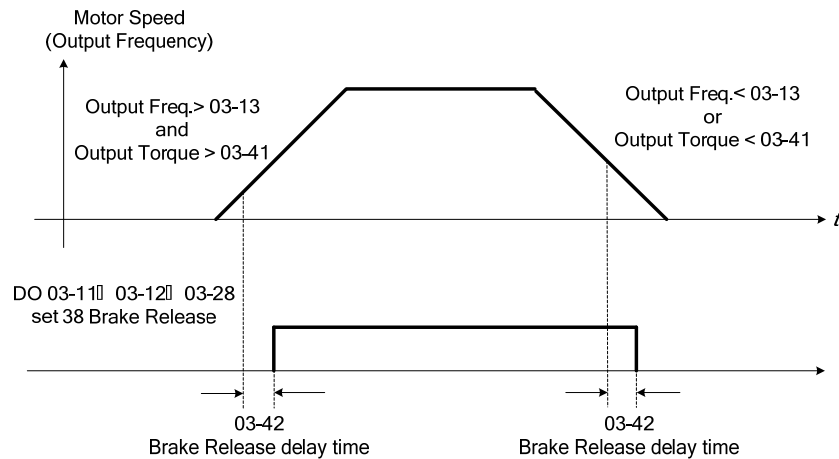

It is recommended to be with starting and stopping frequency locked function (11-43~11-46), shown as the following figure:

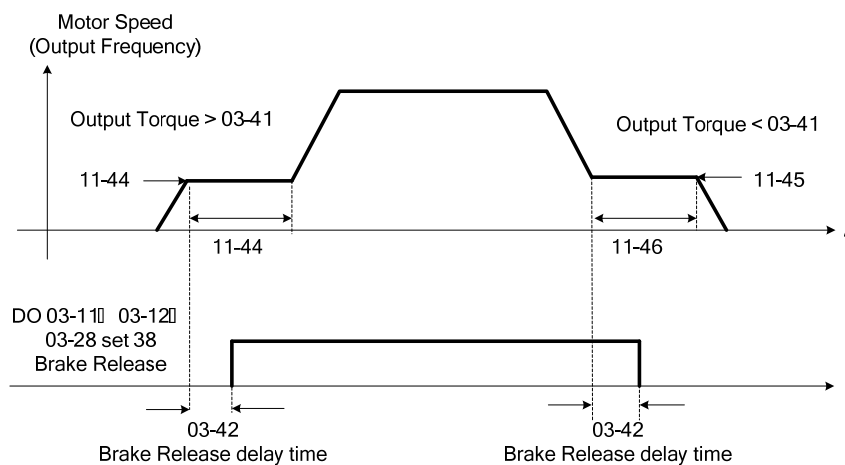

03-43	UP/DOWN Acceleration/ Deceleration Selection
Range	【0】 : Acceleration/Deceleration Time 1 【1】 : Acceleration/Deceleration Time 2

Calculate the acceleration/ deceleration time of frequency command by switch the function of UP/DOWN from parameter 03-43. Ex: $\Delta H1$ (set frequency increment at acceleration) and $\Delta H2$ (set frequency increment at deceleration).

04-External Analog Input / Output Parameter

04-00	AI input signal type
Range	0: AI1: 0~10V AI2: 0~10V/ 0~20mA 1: AI1: 0~10V AI2: 4~20mA/ 2~10V 2: AI1: -10~10V AI2: 0~10V/ 0~20mA 3: AI1: -10~10V AI2: 4~20mA/ 2~10V
04-01	AI1 signal scanning and filtering time
Range	0.00~2.00 Sec
04-02	AI1 gain
Range	0.0~1000.0%
04-03	AI1 bias
Range	-100~100.0%
04-05	AI2 function setting
Range	0: Auxiliary frequency 1: Frequency Reference Gain 2: Frequency Reference bias 3: Output Voltage Bias 4: Coefficient of acceleration and deceleration reduction 5: DC braking current 6: Over-torque Detection Level 7: Stall prevention Level During Running 8: Frequency lower limit 9: Jump frequency 4 10: Added to AI1 11: Positive torque limit 12: Negative torque limit 13: Regenerative Torque Limit 14: Positive / negative torque limit 15: Reserved 16: Torque command/ Torque compensation 17: PTC Overheat Protection
04-06	AI2 signal scanning and filtering time
Range	0.00~2.00Sec
04-07	AI2 gain
Range	0.0~1000.0%
04-08	AI2 bias
Range	-100.0~1000.0%

Refer to the followings for 04-00 AI input signal type:

If AI1 is 0~10V, set parameter 04-00 to 0 or 1.

If AI1 is -10~10V, set parameter 04-00 to 2 or 3.

If AI2 is 0~10V, set parameter 04-00 to 0 or 2 and tune SW2 on the control board to V.

If AI2 is 0~20mA, set parameter 04-00 to 0 or 2 and tune SW2 on the control board to I.

If AI2 is 4~20mA, set parameter 04-00 to 1 or 3, tune SW2 on the control board to I.

If AI2 is 2~10V, set parameter 04-00 to 1 or 3, tune SW2 on the control board to V.

(1) Analog Input Level Adjustment AI1, AI2 (04-02, 04-03, 04-07, 04-08)

Each analog input AI1 and AI2 has a separate gain and bias parameter associated with it.

Analog input signal AI1 can be adjusted with parameter 04-02 and 04-03; Analog input signal AI2 can be adjusted with parameter 04-07 and 04-08. Refer to Figure 4.4.35.

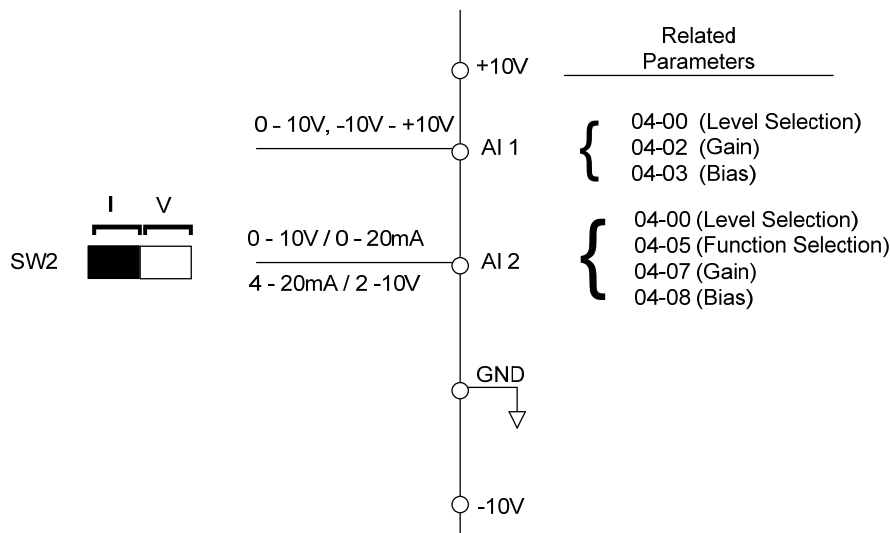

Figure 4.4.35 Analog inputs and related parameters

Gain setting: Sets the level in % that corresponds to a 10V, -10V or 20mA signal at the analog input.

(Set the maximum output frequency 01-02 to 100 %)

Bias setting: Sets the level in % that corresponds to a 0V or 4mA signal at the analog input.

(Set the maximum output frequency 01-02 to 100%)

Use both gain and bias setting to scale the input signal.

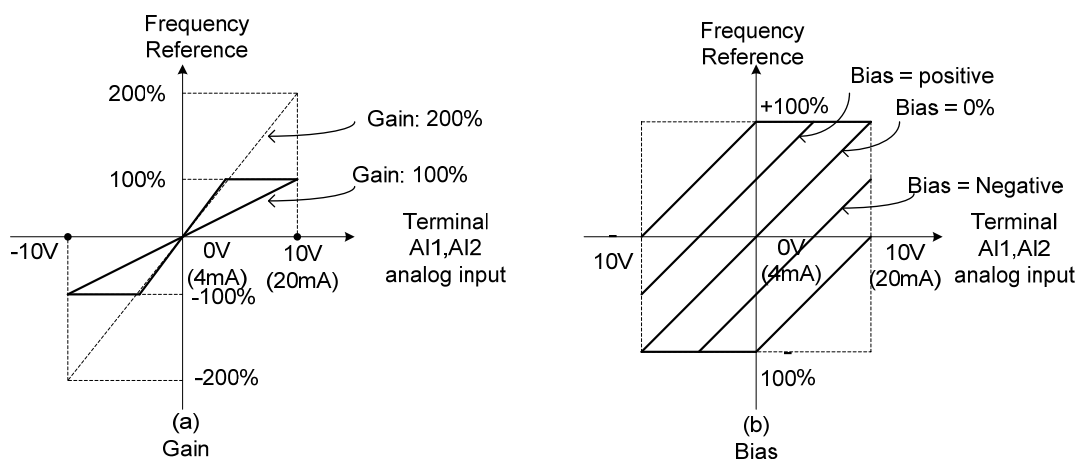

Figure 4.4.36 Gain and bias operations (for frequency reference signal)

(2) AI1 signal filtering time (04-01)

(3) AI2 signal filtering time (04-06)

All analog inputs (AI1, AI2) have a 1st order programmable input filter that can be adjusted when noise is present on each of the incoming analog signal to prevent erratic drive control.

The filter time constant (range: 0.00 to 2.00 seconds) is defined as the time that the input step signal reaches 63% of its final value.

Note: Increasing the filter time causes the drive operation to become more stable but less responsive to change to the analog input.

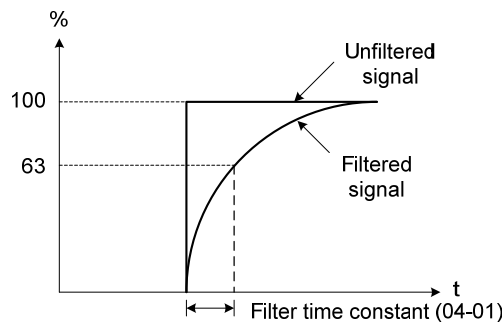

Figure 4.4.37 Filter time constant

(4) AI2 function setting (04-05)

AI2 is multi-function analog input terminal function selection. Refer to Table 4.4.11 for function overview.

Table 4.4.32 Multi-function analog input list (04-05 setting)

Setting	Function		Description	Control mode		
	Name	Screen display		V/F	SLV	SLV2
0	Auxiliary frequency	AUX.Freq Ref	Max Output Frequency (01-02, Fmax) = 100%	○	○	○
1	Frequency Reference Gain (FGAIN)	Freq Ref Gain	Aggregated gain = AI1 = 04-02 * FGAIN	○	○	○
2	Frequency Reference bias (FBIAS)	Freq Ref Bias	Aggregated bias = AI1 = 04-03 * FBIAS	○	○	○
3	Output Voltage Bias (VBIAS)	Output Volt Bias	Aggregate output voltage = V/F curve voltage + VBIAS	○	×	○
4	Coefficient of acceleration and deceleration reduction (K)	Tacc/Tdec Scaling	Actual acceleration and deceleration time = acceleration and deceleration time	○	○	○
5	DC braking current	DC Inj Current	Adjust the DC braking current (0 ~ 100%) based on analog input. When the inverter rated current = 100%, DC braking current 07-07 is disabled.	○	○	○
6	Over-torque detection level	Over Tq Level	Change over-torque detection level based on over-torque detection level, at this time, 08-15 is disabled.	○	○	○
7	Stall prevention Level During Running	Run Stall Level	Adjust the action level (30% ~ 200%) of stall prevention in operation based on analog input. The inverter rated current = 100%.	○	×	○

Setting	Function		Description	Control mode		
	Name	Screen display		V/F	SLV	SLV2
8	Frequency lower limit	Ref. Low Bound	Adjust the lower limit (0 to 100%) of frequency command based on analog input, the maximum output = 100%. The lower limit of frequency command is the greater one of the actual frequency command's lower limit 00-13 or the multi-function analog input.	○	○	○
9	Jump frequency 4	Jump Freq 4	Jump frequency 4. 100% = maximum output frequency	○	○	○
10	Added to AI1	Add to AI1	Added to AI1. 100% = maximum output frequency	○	○	○
11	Positive torque limit	Positive Tq Limit	100% = motor's rated torque	X	○	X
12	Negative torque limit	Negative Tq Limit	100% = motor's rated torque	X	○	X
13	Regenerative Torque Limit	Regen. Tq Limit	100% = motor's rated torque	X	○	X
14	Positive / negative torque limit	+/- Tq Limit	100% = motor's rated torque	X	○	X
15	Reserved			-	-	-
16	Torque command/ Torque compensation	Tq Compensation	100% = motor's rated torque	X	○	X
17	PTC Overheat Protection	PTC overheat Stall	Use the PTC sensor in the motor to stop from overheats.	○	○	○

04-05=0: Auxiliary frequency

When parameter 00-05 = 1 (main frequency from external control) the auxiliary speed reference frequency can be activated via the multi-speed input commands (see table 4.4.7). The auxiliary frequency command can be set via AI2. The maximum output frequency is set by 01-02, $F_{max} = 100\%$.

04-05=1: Frequency Reference Gain (FGAIN)

Multi-function analog input AI2 can be used to adjust the frequency reference gain of analog input AI1.

The total frequency reference gain of terminal AI1 is the internal gain set by parameter 04-02 times FGAIN.

The maximum frequency reference for AI1 is 100%.

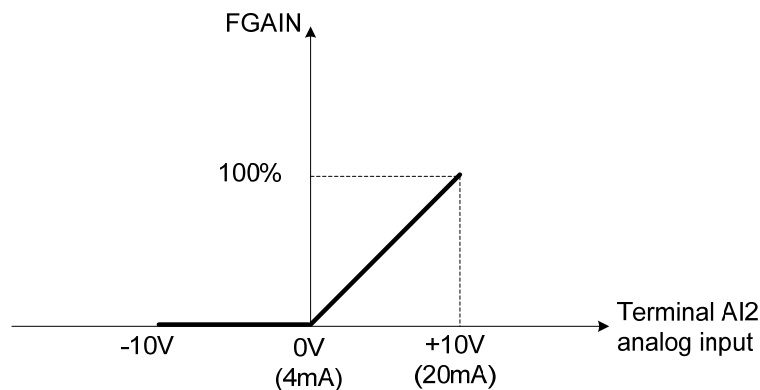

Figure 4.4.38 Frequency gain adjustment

Example:

When the internal gain of AI1 (04-02) is set to 100% and AI2 to 5V (for example FGAIN = 50%), the reference frequency of terminal AI1 will be 50%, as shown in Figure 4.4.39.

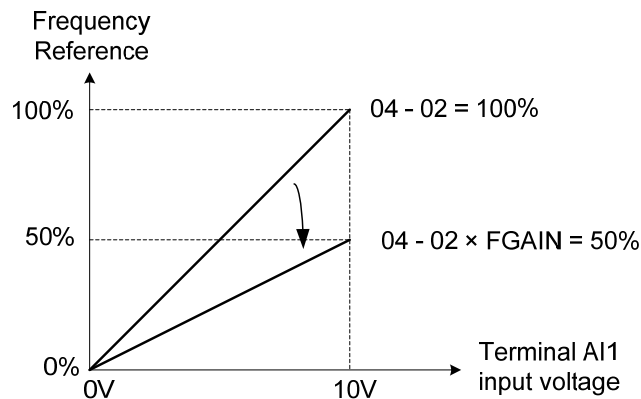

Figure 4.4.39 Frequency reference gain adjustment (example)

04-05=2: Frequency Reference bias (FBIAS)

Multi-function analog input terminal AI2 can be used to adjust the frequency reference bias of AI1. The total frequency reference bias of terminal AI1 is the sum of internal bias set by parameter 04-03 and FBIAS. The maximum frequency reference for AI1 is 100%.

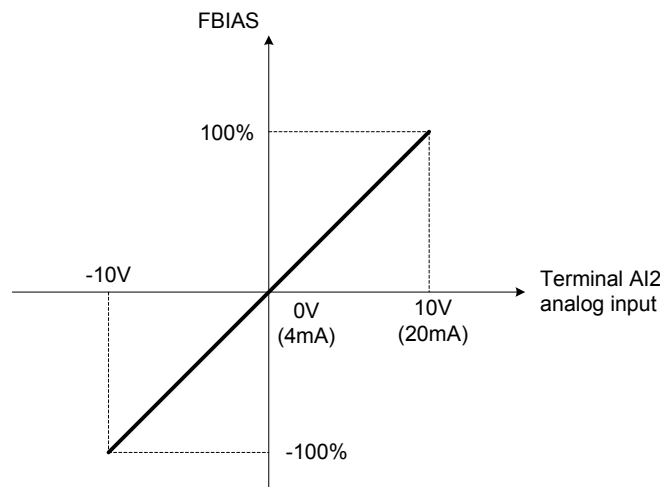

Figure 4.4.40 Bias adjustment

Example:

Terminal AI1 input is 0V, 04-02 = 100% (AI1 gain), 04-03 = 0% (AI1 bias) and terminal AI2 input is 3V. The reference frequency will be 30% as shown in Figure 4.4.41.

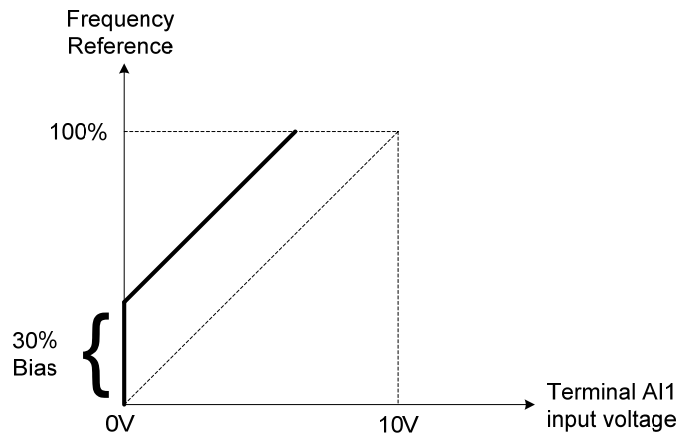

Figure 4.4.41 Frequency Reference bias adjustment (example)

04-05=3: Output Voltage Bias (VBIAS)

Multi-function analog input AI2 can be used to adjust the output voltage. The total output voltage of inverter is the sum of output voltage based on the selected V/F curve and VBIAS.

The maximum output voltage is set by 01-03, $V_{max} = 100\%$.

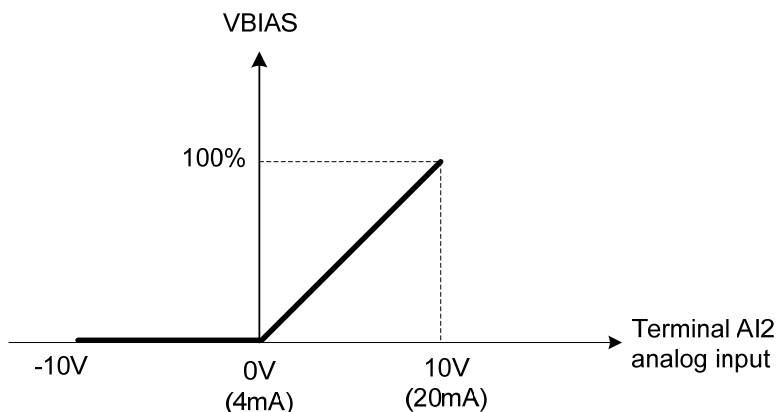

Figure 4.4.42 Bias adjustment

04-05=4: Acceleration and deceleration coefficient (K)

Multi-function analog input AI2 can be used to adjust the acceleration and deceleration time coefficient. The actual acceleration and deceleration time is calculated as follows:

$$\text{Actual accel / decel time} = \frac{\text{Acceleration / Deceleration time (00-14 ~ 00-17, 00-21, 00-24)}}{K}$$

Acceleration/ Deceleration time setting is 100% (00-14~00-17, 00-21~00-24).

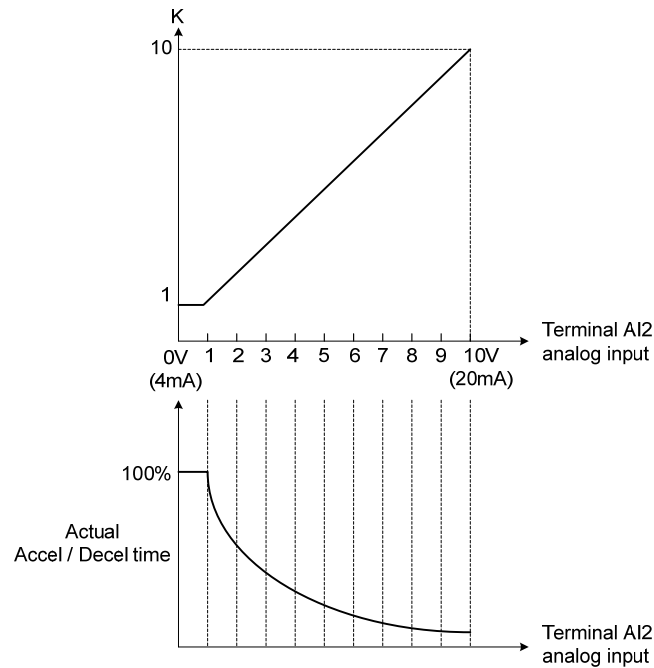

Figure 4.4.43 Acceleration / deceleration time reduction coefficient

04-05=5: DC braking current

Multi-function analog input AI2 can be used to adjust the DC Injection braking current. DC braking current parameter 07-07 setting should be set to 0% to use this function. The inverter rated current = 100%

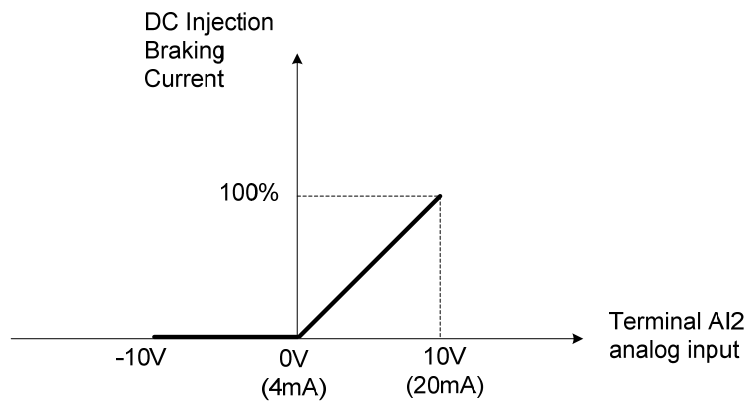

Figure 4.4.44 DC braking current adjustment

04-05=6: Over-torque detection level

Multi-function analog input AI2 can be used to adjust the over-torque detection level.

100% of inverter rated current (V/F control mode)

100% motor rated torque (SLV control mode)

If the multi-function analog input is used to adjust the over-torque level, the internal over-torque detection level (08-15) is disabled.

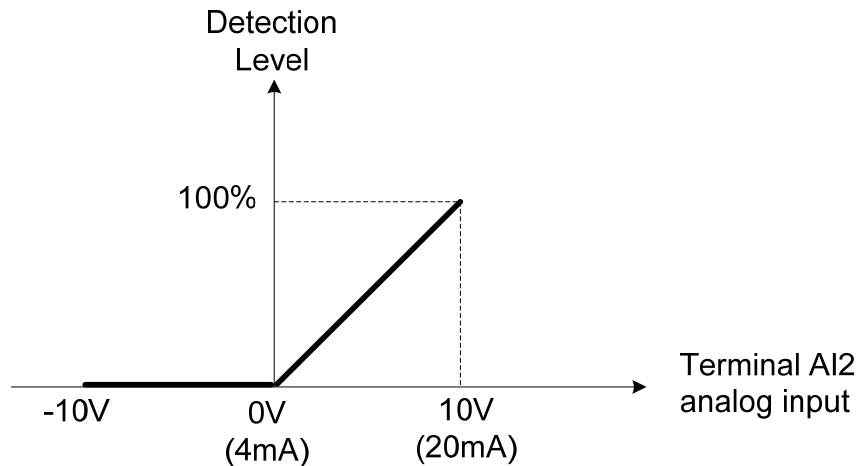

Figure 4.4.45 Over-torque detection level adjustment

4-05=7: Stall prevention level during running

Multi-function analog input AI2 can be used to adjust the stall prevention level during operation.

Inverter rated current = 100%. When AI2 is set to control stall prevention level (04-05 = 7) and parameter 08-03 (Stall prevention level during operation) is used, then the lesser of the two value becomes the active stall prevention level during operation.

Example: If the motor power is less than that of the inverter, the operation and the stall prevention of the motor will be based on the factory settings, multi-function analog input AI2 can be used to reduce the stall prevention level during operation.

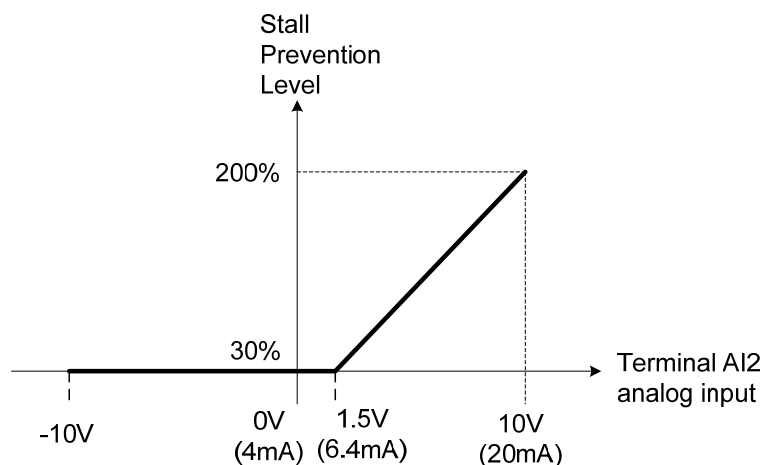

Figure 4.4.46 Stall prevention level adjustment in operation

04-05=8: Frequency lower limit

Multi-function analog input AI2 can be used to adjust the lower limit of frequency reference.

Maximum output frequency (F_{max} , 01-02) = 100%. The actual lower limit is determined by the maximum value of 00-13 (frequency lower limit) and level of the multi-function analog input AI2.

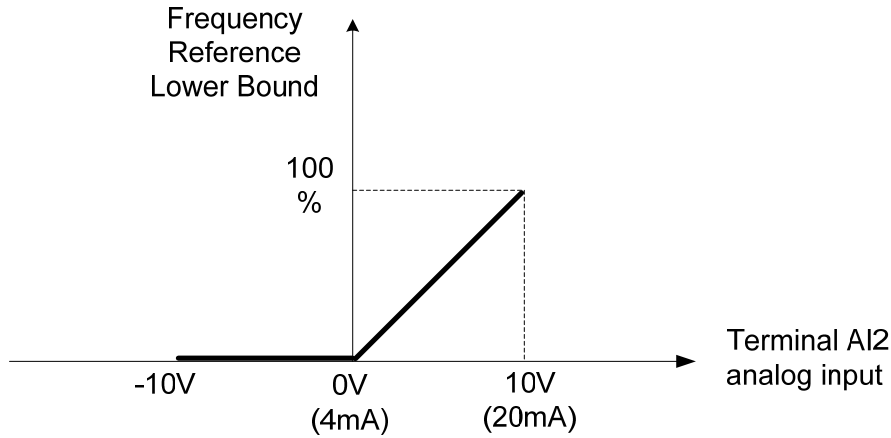

Figure 4.4.47 Adjustment of lower limit of frequency reference

04-05=9: Jump frequency 4

Multi-function analog input AI2 can be used to adjust Jump frequency 4.

Maximum output frequency (01-02, Fmax) = 100%. Setting 11-08 to 11-10 to 0.0Hz turns of the Jump frequency function.

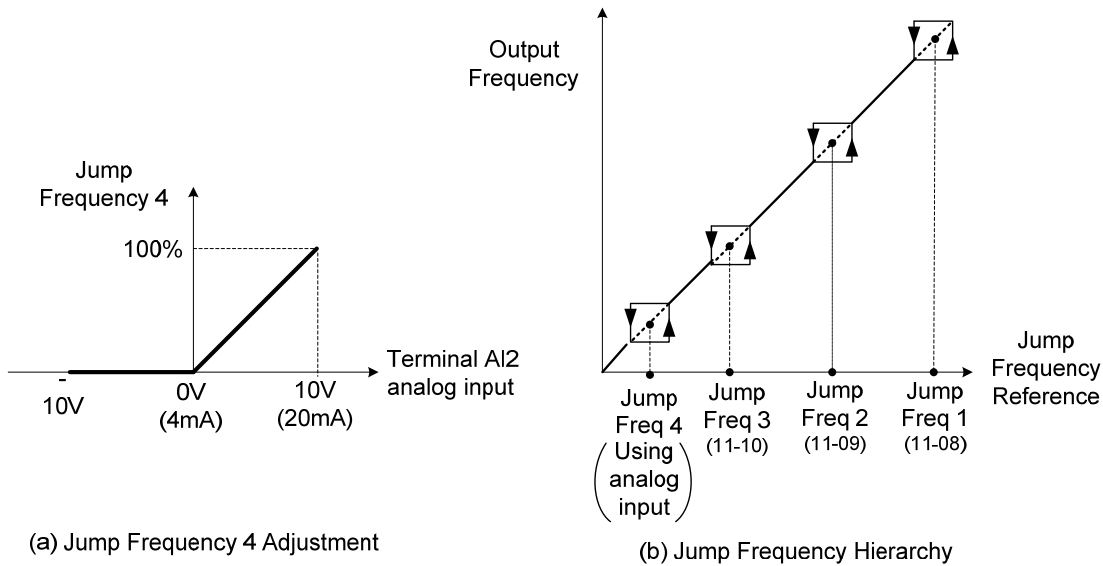

Figure 4.4.48 Jump frequency 4 Setting Operation

04-05=10: Added to AI1

Multi-function analog input AI2 can be used as a bias level for analog input AI1.

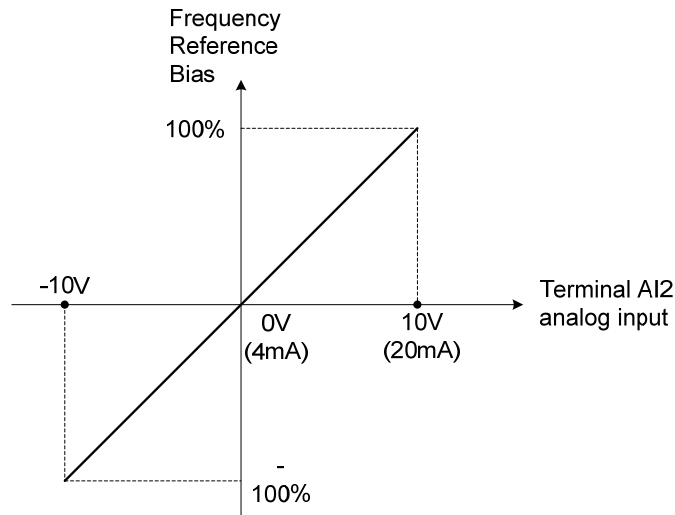

Figure 4.4.49 Operation of being added to AI1 as bias

Example:

04-02 (AI1 gain) = 100%, 04-03 (AI2 gain) = 0%, and terminal AI2 level is 2V. If input terminal AI1 is 0V, the internal reference frequency of terminal AI1 will be 20 %.

04-05=11: Positive torque limit

Multi-function analog input AI2 can be used to adjust the positive torque limit.

04-05=12: Negative torque limit

Multi-function analog input AI2 can be used to adjust the negative torque limit.

04-05=13: Regenerative torque limit

Multi-function analog input AI2 can be used to adjust the regenerative torque limit.

04-05=14: Positive / negative torque limits

Multi-function analog input AI2 can be used to adjust both the positive and negative torque limit.

For more details on torque limits, please refer to parameter group 21 - torque and position control group.

04-05=17: PTC Overheat Protection

Use the sensor in the motor to stop from overheats. Please refer to 08-42~08-44 description for more details.

04-11	AO1 function Setting
Range	<p>0: Output frequency 1: Frequency command 2: Output voltage 3: DC voltage 4: Output current 5: Output power 6: Motor speed 7: Output power factor 8: AI1 input 9: AI2 input</p>

	<p>10: Torque command 11: q -axis current 12: d-axis current 13~16: Reserved 17: q-axis voltage 18: d-axis voltage 19~20: Reserved 21: PID input 22: PID output 23: PID target value 24: PID feedback value 25: Output frequency of the soft starter 26~27: Reserved 28: Communication control</p>
--	---

04-12	AO1 gain
Range	0.0~1000.0%

04-13	AO1 bias
Range	-100.0~100.0%

04-16	AO2 function Setting
Range	See parameter 04-11

04-17	AO2 gain
Range	0.0~1000.0%

04-18	AO2 bias
Range	-100.0~100.0%

For the analog output and related parameters, refer to figure 4.4.50.

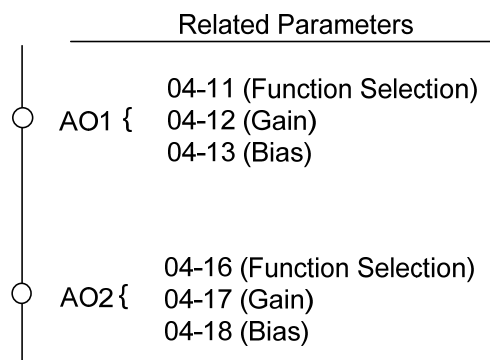

Figure 4.4.50 Analog outputs and related parameters

Analog output AO1 and AO2 adjustment (04-12, 04-13 and 04-17, 04-18)

Signal: Use parameter 04-11 to select the analog output signal for AO1 and parameter 04-16 to select the analog output signal for AO2.

Gain: Use parameter 04-12 to adjust the gain for AO1 and parameter 04-17 to adjust the gain for AO2. Adjust the gain so that the analog output (10V/20mA) matches 100% of the selected analog output signal (04-11 for AO1 and 04-16 for AO2).

Bias: Use parameter 04-13 to adjust the bias for AO1 and parameter 04-18 to adjust the bias for AO2. Adjust the bias so that the analog output (0V/4mA) matches 0% of the selected analog output signal (04-11 for AO1 and 04-16 for AO2).

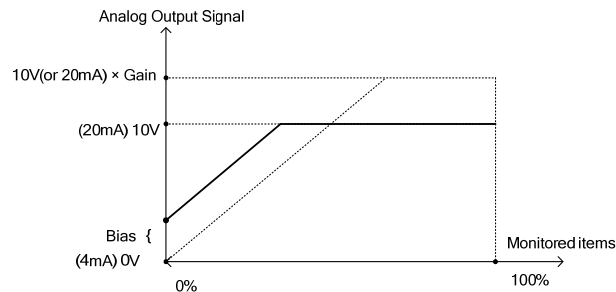

Figure 4.4.51 Analog output level adjustment

Analog output terminal function selection (04-11 and 04-16)

Refer to the following table 4.4.33.

Table 4.4.33 Selection of analog output terminals function (04-11 and 04-16)

04-11, 04-16 Parameter setting	Function	Monitoring Parameters Group 12	Control Mode		
			VF	SLV	SLV2
0	Output Freq	12-17	○	○	○
1	Freq Ref	12-16	○	○	○
2	Output Voltage	12-19	○	○	○
3	DC Voltage	12-20	○	○	○
4	Output Current	12-18	○	○	○
5	Output KW	12-21	○	○	○
6	Motor Speed	12-22	○	○	○
7	Output PF	12-23	○	○	○
8	AI1 Input	12-25	○	○	○
9	AI2 Input	12-26	○	○	○
10	Torque Ref	12-27	X	○	X
11	Current Iq	12-28	X	○	X
12	Current Id	12-29	X	○	X
13	Speed Deviation	12-30	X	X	X
14~20	Reserved	-	X	X	X
21	PID Input	12-36	○	○	○
22	PID Output	12-37	○	○	○
23	PID Setpoint	12-38	○	○	○
24	PID Feedback	12-39	○	○	○

04-19	AO2 Output Signal Type
Range	【0】 : AO2 0~10V 【1】 : AO2 4~20mA

It is required to be with the setting of SW1 on the control board when AO2 analog output signal type is active.

When 04-19=0 (AO2 is 0~10V) and SW1 on the control board is V, AO2 output signal type is voltage.

When 04-19=1 (AO2 is 4~20mA and SW1 on the control board is I, AO2 output signal type is current.

04-20	Filter Time of AO Signal Scan
Range	【0.00~0.50】 Sec

Setting of parameter 04-20 is used for filtering momentary change in analog output signal. When it is enabled, system response will lower down and interference protection will enhance.

05- Multi-Speed Parameters

05-00	Acceleration and deceleration selection of multi-speed
Range	0: Acceleration and deceleration time 1 ~ 4 used. 1: Use independent acceleration and deceleration time for each multi-speed setting.

05-00=0: Standard Acceleration and deceleration times parameters 00-14 ~ 00-17 / 00-21 ~ 00-24 are used for multi-speed 0 ~ 15.

05-00=1: Each multi-speed uses a dedicated acceleration and deceleration time parameters 05-17 ~ 05-48. There are two different modes for acceleration / deceleration timing when 05-00 is set to 1, see time example on the next page.

Acceleration time calculation formula

$$\text{Time it takes to reach set frequency} = \frac{\text{Acceleration time} \times (\text{set frequency} - \text{output frequency})}{\text{Maximum output frequency}}$$

Deceleration time calculation formula

$$\text{Time it takes to reach set frequency} = \frac{\text{Deceleration time} \times (\text{output frequency} - \text{set frequency})}{\text{Maximum output frequency}}$$

Maximum output frequency: Parameter 01-00=F, maximum output frequency set by 01-02, 01-00 ≠ F, maximum output frequency determined by V/F curve selected (50.0 / 60.0 / 90.0 / 120.0 / 180.0).

Example: 01-00=01 (50Hz (maximum output frequency), 05-02=10 Hz (multi-step speed 0), 05-17=5.0s (Acceleration time), 05-18=20.0 sec. (Deceleration time).

Acceleration time calculation formula

$$\text{Time it takes to reach set frequency} = \frac{5.0 \times 10 \text{ Hz}}{50 \text{ Hz}} = 1.0 \text{ sec.}$$

Deceleration time calculation formula

$$\text{Time it takes to reach set frequency} = \frac{20.0 \times 10 \text{ Hz}}{50 \text{ Hz}} = 4.0 \text{ sec.}$$

Example: Acceleration / deceleration timing when 05-00 is set to 1. In this example the following parameters are set:

- 00-02=1 (External Terminal Operation)
- 03-00=0 (Terminal S1: Forward /Stop)
- 03-01=1 (Terminal S2: Reversal /Stop)
- 03-02=2 (Terminal S3: Speed 1)
- 03-03=3 (Terminal S4: Speed 2)
- 03-03=4 (Terminal S5: Speed 3)

*Speed 1 is required to confirm if AI2 function setting (04-05) is set to 0 (Auxiliary frequency). If 04-05=0, it will make the frequency of speed 1 set to AI2 auxiliary frequency and the value is determined by AI2. If function of speed 1 is generally used, set AI2 to other functions except 0 (the recommended value: set 10 ADD to AI1.)

Acceleration / Deceleration Calculation Mode 1:

If the run command is cycled on and off, acceleration and deceleration time (a ~ f) is calculated based on the active speed command as follows:

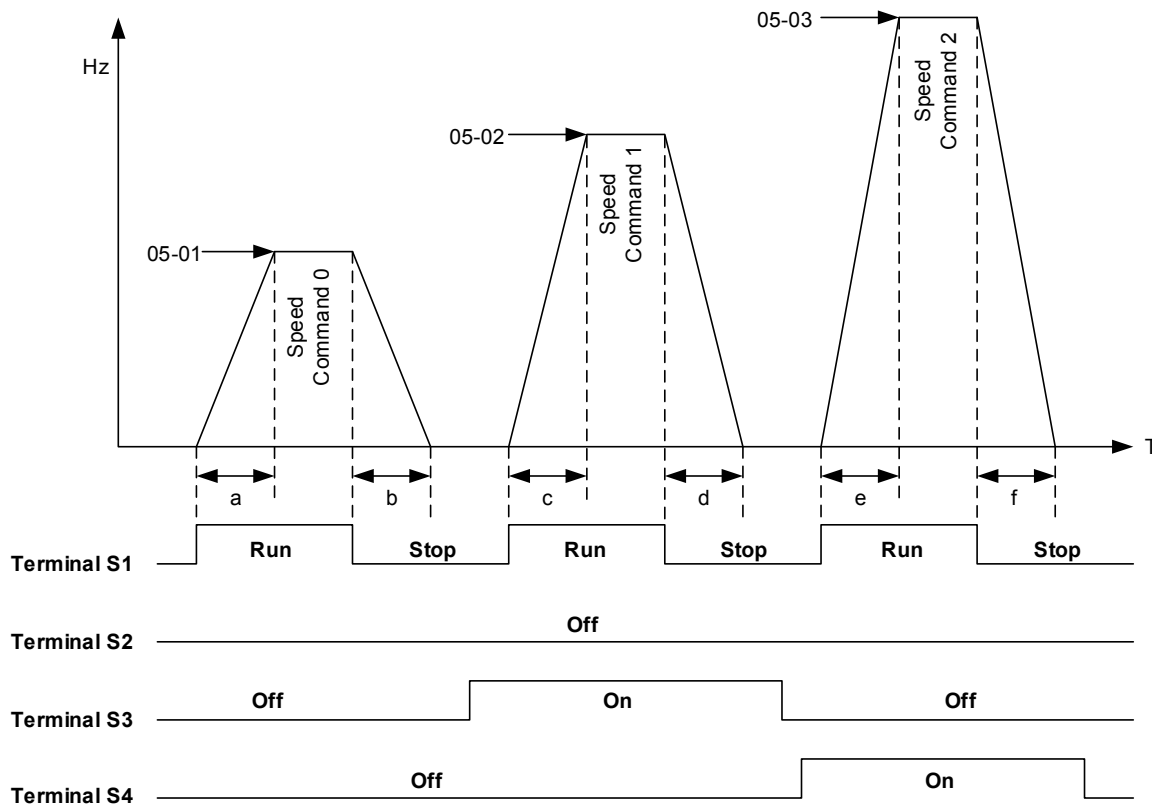

$$a = \frac{(05-17) \times (05-01)}{(01-02)} \quad b = \frac{(05-18) \times (05-01)}{(01-02)} \quad c = \frac{(05-19) \times (05-02)}{(01-02)} \quad \text{in sec.}$$

$$d = \frac{(05-20) \times (05-02)}{(01-02)} \quad e = \frac{(05-21) \times (05-03)}{(01-02)} \quad f = \frac{(05-22) \times (05-03)}{(01-02)} \quad \text{in sec.}$$

Acceleration / Deceleration Calculation Mode 2:

If the run command is remains on, acceleration and deceleration time (a ~ f) is calculated based on the active speed command as follows:

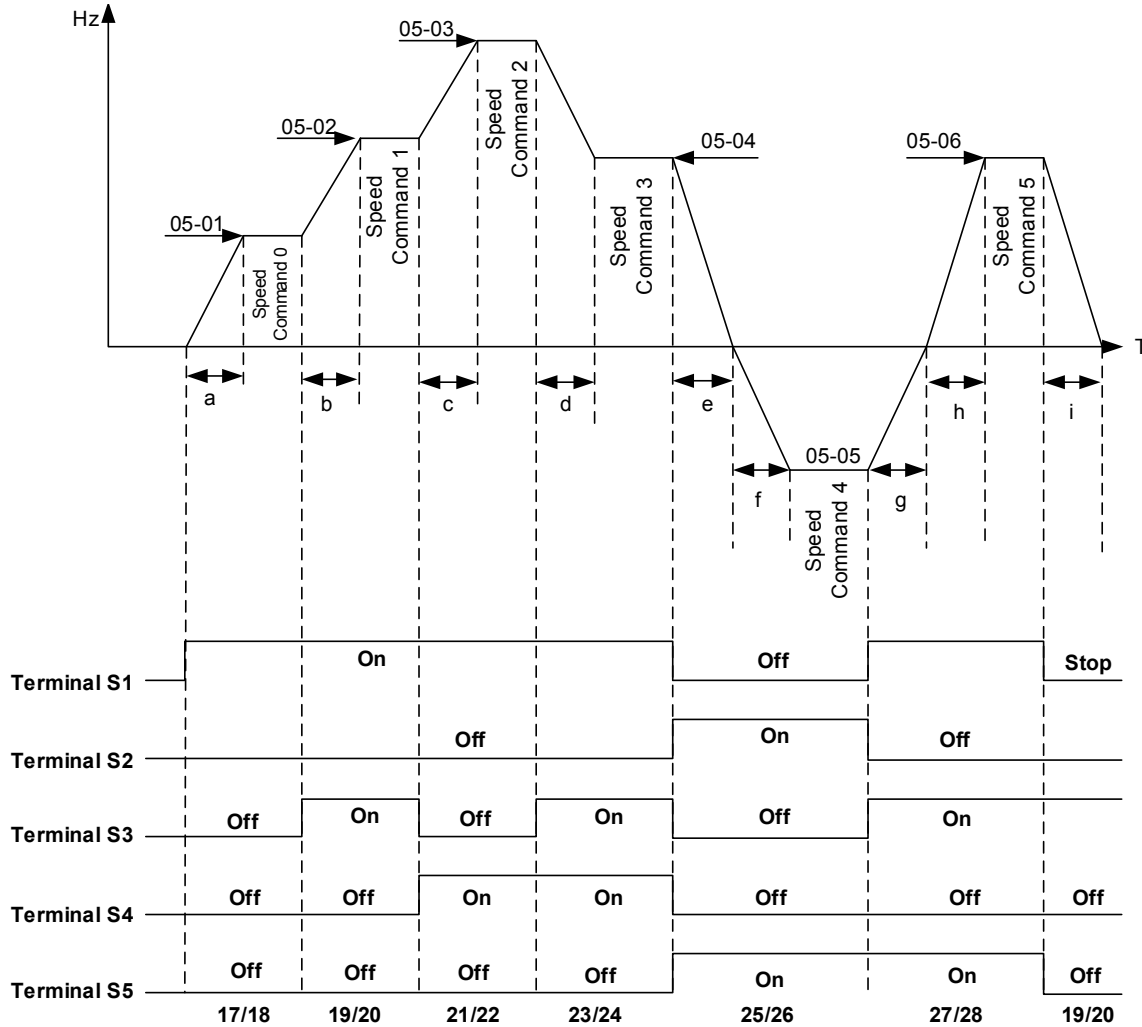

$$a = \frac{(05-17) \times (05-01)}{(01-02)} \quad b = \frac{(05-19) \times [(05-02) - (05-01)]}{(01-02)} \quad c = \frac{(05-21) \times [(05-03) - (05-02)]}{(01-02)} \quad \text{in sec.}$$

$$d = \frac{(05-24) \times [(05-03) - (05-04)]}{(01-02)} \quad e = \frac{(05-26) \times (05-04)}{(01-02)} \quad f = \frac{(05-25) \times (05-05)}{(01-02)} \quad \text{in sec.}$$

$$g = \frac{(05-27) \times (05-05)}{(01-02)} \quad h = \frac{(05-27) \times (05-06)}{(01-02)} \quad i = \frac{(05-19) \times (05-06)}{(01-02)} \quad \text{in sec.}$$

05-01	Frequency setting of speed-stage 0
Range	0.0~599.00 Hz
05-17	Acceleration time setting for multi speed 0
Range	0.0~6000.0 Sec
05-18	Deceleration time setting for multi speed 0
Range	0.0~6000.0 Sec
05-19	Acceleration time setting for multi speed 1
Range	0.0~6000.0 Sec
05-20	Deceleration time setting for multi speed 1
Range	0.0~6000.0 Sec
05-21	Acceleration time setting for multi speed 2
Range	0.0~6000.0 Sec
05-22	Deceleration time setting for multi speed 2
Range	0.0~6000.0 Sec
05-23	Acceleration time setting for multi speed 3
Range	0.0~6000.0 Sec
05-24	Deceleration time setting for multi speed 3
Range	0.0~6000.0 Sec
05-25	Acceleration time setting for multi speed 4
Range	0.0~6000.0 Sec
05-26	Deceleration time setting for multi speed 4
Range	0.0~6000.0 Sec
05-27	Acceleration time setting for multi speed 5
Range	0.0~6000.0 Sec
05-28	Deceleration time setting for multi speed 5
Range	0.0~6000.0 Sec
05-29	Acceleration time setting for multi speed 6
Range	0.0~6000.0 Sec
05-30	Deceleration time setting for multi speed 6
Range	0.0~6000.0 Sec
05-31	Acceleration time setting for multi speed 7
Range	0.0~6000.0 Sec

05-32	Deceleration time setting for multi speed 7
Range	0.0~6000.0 Sec
05-33	Acceleration time setting for multi speed 8
Range	0.0~6000.0 Sec
05-34	Deceleration time setting for multi speed 8
Range	0.0~6000.0 Sec
05-35	Acceleration time setting for multi speed 9
Range	0.0~6000.0 Sec
05-36	Deceleration time setting for multi speed 9
Range	0.0~6000.0 Sec
05-37	Acceleration time setting for multi speed 10
Range	0.0~6000.0 Sec
05-38	Deceleration time setting for multi speed 10
Range	0.0~6000.0 Sec
05-39	Acceleration time setting for multi speed 11
Range	0.0~6000.0 Sec
05-40	Deceleration time setting for multi speed 11
Range	0.0~6000.0 Sec
05-41	Acceleration time setting for multi speed 12
Range	0.0~6000.0 Sec
05-42	Deceleration time setting for multi speed 12
Range	0.0~6000.0 Sec
05-43	Acceleration time setting for multi speed 13
Range	0.0~6000.0 Sec
05-44	Deceleration time setting for multi speed 13
Range	0.0~6000.0 Sec
05-45	Acceleration time setting for multi speed 14
Range	0.0~6000.0 Sec
05-46	Deceleration time setting for multi speed 14
Range	0.0~6000.0 Sec
05-47	Acceleration time setting for multi speed 15
Range	0.0~6000.0 Sec
05-48	Deceleration time setting for multi speed 15
Range	0.0~6000.0 Sec

06-Automatic Program Operation Parameters

06-00	Automatic operation mode selection
Range	<p>0: Disable</p> <p>1: Execute a single cycle operation. Restart speed is based on the previous stopped speed.</p> <p>2: Execute continuous cycle operation. Restart speed is based on the previous cycle stop speed.</p> <p>3: After completion of a single cycle, the on-going operation speed is based on the speed of the last stage. Restart speed is based on the previous stopped speed</p> <p>4: Execute a single cycle operation. Restart speed is based on the Speed-Stage 0.</p> <p>5: Execute continuous cycle operation. Restart speed is based on the Speed-Stage 0.</p> <p>6: After completion of a single cycle, the on-going operation speed is based on the speed of the last stage. Restart speed is based on the Speed-Stage 0</p>

Automatic operation mode uses frequency reference parameters 05-01, 06-01~06-15, operation time parameters 06-16 ~ 06-31 and direction of operation parameters 06-32~06-47.

Notes:

The automatic operation mode is disabled when any of the following functions are active:

- Frequency wobbling function
- PID function

When automatic operation mode is active, external multi-step speed reference command 1~4 (03-00~03-05=2~5) is disabled.

Example 1: Automatic operation mode – Single cycle

In this example the inverter executes a single cycle and then stops.

Parameter Settings:

06-00 =	1 or 4 (Single cycle operation)
06-32~06-34=	1 (Forward for multi-step speed 0 - 2)
06-47=	2 (Reverse for multi-step speed 15)
06-35~06-46=	0 (Stop for multi-step speed 3 - 14)
05-01=	15 Hz (Multi-step speed 0: 15 Hz)
06-01=	30 Hz (Multi-step speed 1: 30 Hz)
06-02=	50 Hz (Multi-step speed 2: 50 Hz)
06-15=	20Hz (Multi-step speed 15: 20 Hz)
06-16=	20 sec (Multi-step time 0: 20 sec)
06-17=	25 sec (Multi-step time 1: 25 sec)
06-18=	30 sec (Multi-step time 2: 30 sec)
06-31=	40 sec (Multi-step time 15: 40 sec)

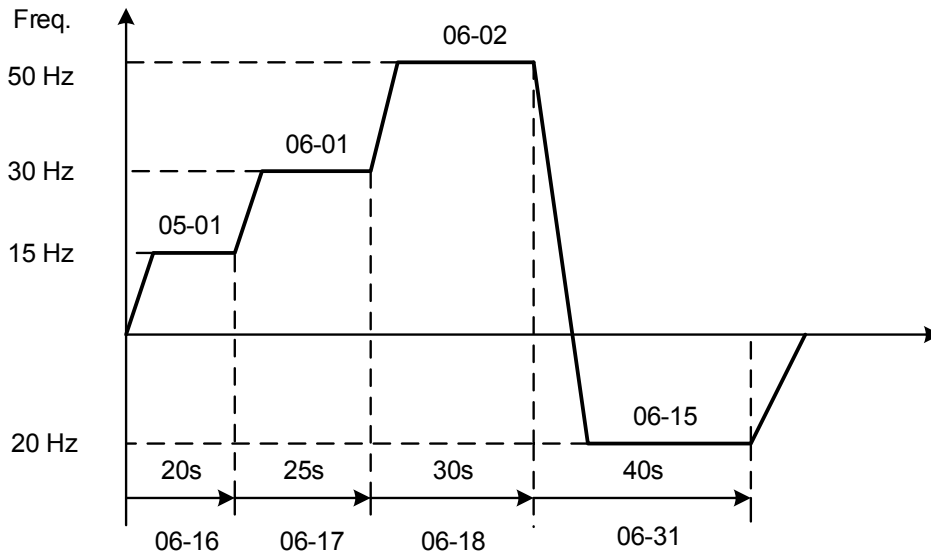

Figure 4.4.52 Single cycle automatic operation (stop)

Example 2: Automatic operation mode – Continuous cycle

In this example the inverter repeats the same cycle.

Parameter Settings:

- 06-00 = 2 or 5 (Continuous cycle operation)
- 06-01~06-47= Enter the same setting as that of Example 1.

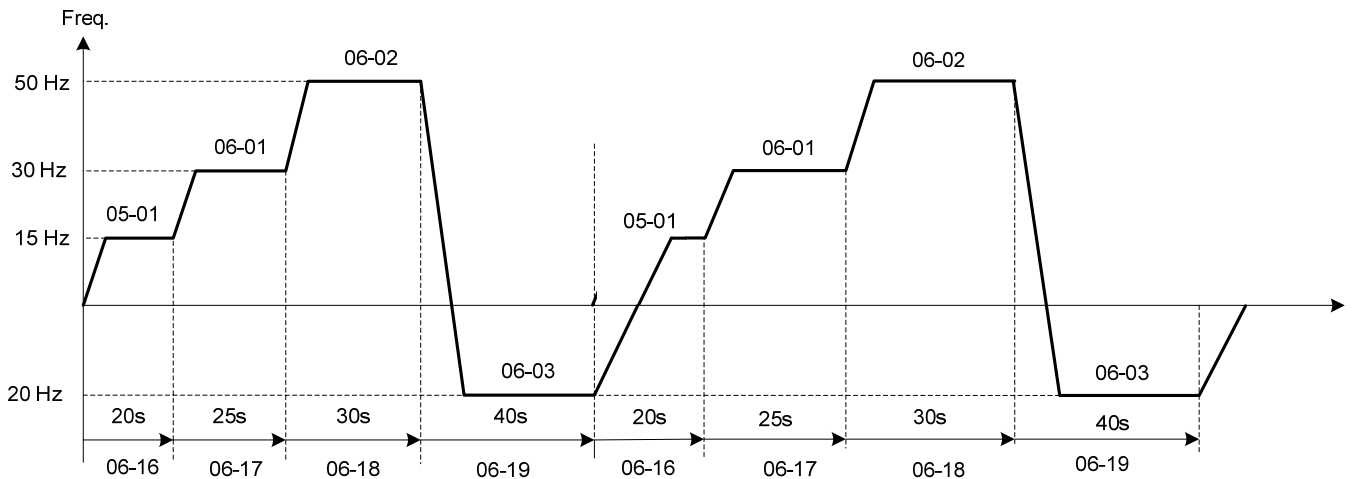

Figure 4.4.53 Periodic automatic operation

Example 3: Automatic operation mode – Single cycle and continue running at last speed of the cycle

In this example the inverter executes a single cycle and continue running at last speed of the cycle.

Parameter Settings:

06-00= 3 or 6 (Single cycle operation)
 06-32~06-35= 1 (Forward)
 06-36~06-47= 0
 Other parameter = Enter same setting as that of Example 1.

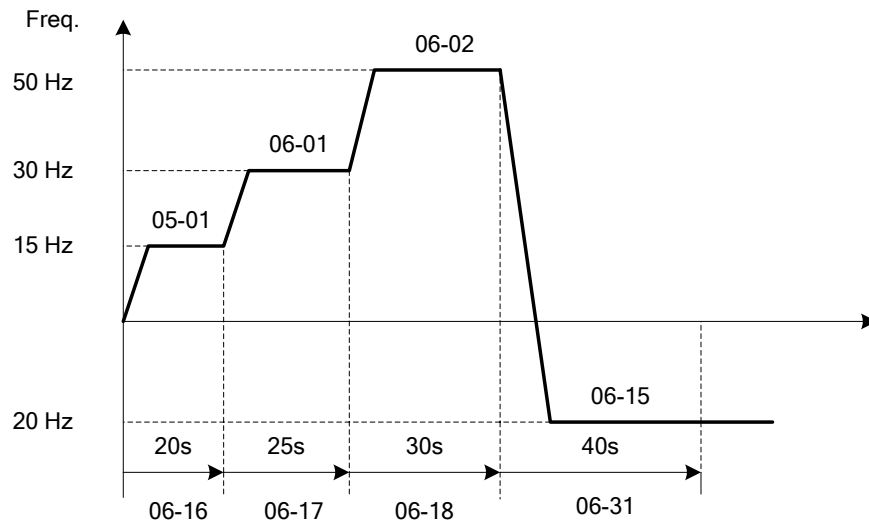

Figure 4.4.54 Single cycle automatic operation (continuous)

06-00= 1 to 3:

After a stop the inverter will restart with the incomplete step when the run command is re-applied.

06-00= 4 to 6:

After a stop the inverter will restart with the first step of the cycle when the run command is re-applied.

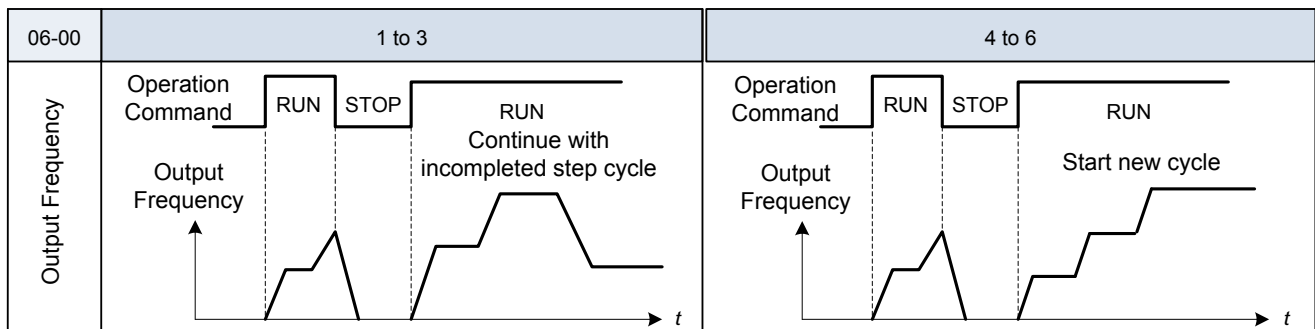

Notes:

- Acceleration/ deceleration time is set with the setting of 00-14 and 00-15 in the automatic operation mode.
- If the setting value of parameters 06-16~06-31 is 0, automatic operation mode is not active.

Automatic operation frequency reference settings	
06-01	Frequency setting of speed-stage 1
06-02	Frequency setting of speed-stage 2
06-03	Frequency setting of speed-stage 3
06-04	Frequency setting of speed-stage 4
06-05	Frequency setting of speed-stage 5
06-06	Frequency setting of speed-stage 6
06-07	Frequency setting of speed-stage 7
06-08	Frequency setting of speed-stage 8
06-09	Frequency setting of speed-stage 9
06-10	Frequency setting of speed-stage 10
06-11	Frequency setting of speed-stage 11
06-12	Frequency setting of speed-stage 12
06-13	Frequency setting of speed-stage 13
06-14	Frequency setting of speed-stage 14
06-15	Frequency setting of speed-stage 15
Range	0.00~599.00 Hz

Automatic operation time settings	
06-16	Operation time setting of speed-stage 0
06-17	Operation time setting of speed-stage 1
06-18	Operation time setting of speed-stage 2
06-19	Operation time setting of speed-stage 3
06-20	Operation time setting of speed-stage 4
06-21	Operation time setting of speed-stage 5
06-22	Operation time setting of speed-stage 6
06-23	Operation time setting of speed-stage 7
06-24	Operation time setting of speed-stage 8
06-25	Operation time setting of speed-stage 9
06-26	Operation time setting of speed-stage 10
06-27	Operation time setting of speed-stage 11
06-28	Operation time setting of speed-stage 12
06-29	Operation time setting of speed-stage 13
06-30	Operation time setting of speed-stage 14
06-31	Operation time setting of speed-stage 15
Range	0.0~6000.0 Sec

Automatic operation direction settings	
06-32	Operation direction selection of speed-stage 0
06-33	Operation direction selection of speed-stage 1
06-34	Operation direction selection of speed-stage 2
06-35	Operation direction selection of speed-stage 3
06-36	Operation direction selection of speed-stage 4
06-37	Operation direction selection of speed-stage 5
06-38	Operation direction selection of speed-stage 6
06-39	Operation direction selection of speed-stage 7
06-40	Operation direction selection of speed-stage 8
06-41	Operation direction selection of speed-stage 9
06-42	Operation direction selection of speed-stage 10
06-43	Operation direction selection of speed-stage 11
06-44	Operation direction selection of speed-stage 12
06-45	Operation direction selection of speed-stage 13
06-46	Operation direction selection of speed-stage 14
06-47	Operation direction selection of speed-stage 15
Range	0: Stop, 1: Forward, 2: Reverse

07- Start/Stop Parameters

07-00	Momentary Power Loss/Fault Restart Selection
Range	0: Disable 1: Enable

07-00=0: Inverter trips on "UV" fault if power loss time is greater than 8ms.

07-00=1: Inverter restarts after restarting the power at the momentary power loss.

Note: When 07-00=1, inverter restore automatically the motor rotation after restarting the power even if momentary power loss occurs.

07-01	Fault reset time
Range	0~7200 Sec

Restart time of momentary power loss is the same as Fault reset time.

07-01 < 07-18: Automatic restart time interval is set by minimum baseblock time (07-18).

07-01 > 07-18: Automatic restart time interval is set by fault reset time (07-01).

Note:

Automatic restart time interval is time of 07-18 plus 07-01 and delay time of peed search (07-22).

Refer to Figure 4.4.55 for automatic restart interval.

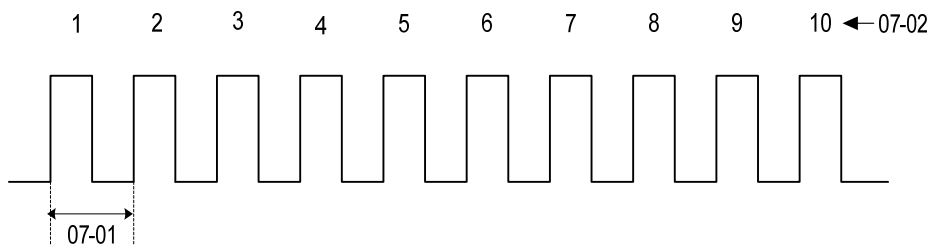

Figure 4.4.55 Automatic restart interval

07-02	Number of restart attempts
Range	0~10

If numbers of fault reset reaches the setting value of 07-02, then inverter stops running. So manual to restart the inverter after eliminating fault causes.

When the automatic restart function is enabled the internal automatic restart attempt counter is reset based on the following actions:

- No fault occurs in 10 minutes or longer after the automatic restart
- Reset command to clear fault via input terminal or using the keypad (ex: press reset/ ◀ key)
- Power to the inverter is turned off and back on again

Note:

Multi-function digital output R1A-R1C, R2A-R2C, or optocoupler output can be programmed to activate during an automatic reset attempt, refer to parameter 03-11, 03-12 and 03-28.

Automatic restart operation:

- Fault is detected. The inverter turn off the output, displays the fault on the keypad and waits for the minimum baseblock time parameter 07-18 to expire before accepting another run / automatic restart command.
- After the minimum baseblock time (07-18) and delay time of speed search have expired, the active fault is reset and a speed search operation is performed. The time between each fault restart attempt is set by parameter 07-01.
- When the total number of restart attempts exceed the number of automatic restart attempts set in parameter 07-02, the inverter will turn off the output and the fault contact is activated.

Please refer to Figure 4.4.56 for the automatic restart operation.

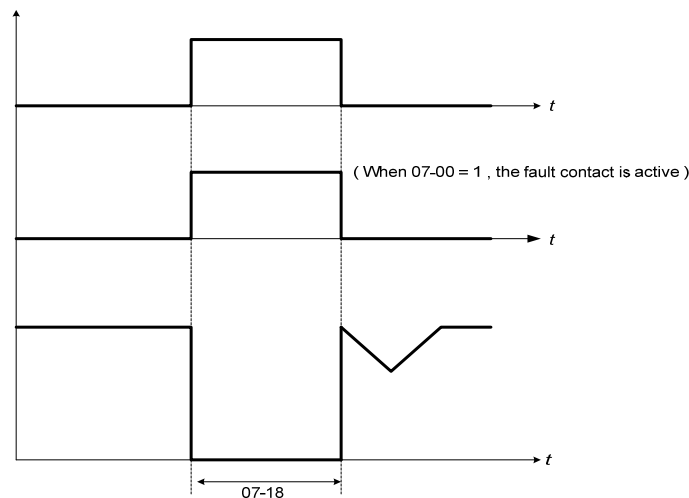

Figure 4.4.56 Auto-restart operation.

The automatic restart function is active for the following faults. Please note that when the fault is not listed in the table the inverter will not attempt an automatic restart.

Parameter Name	Faults	Numbers of Restart
07-00	UV (under voltage)	Unlimited
07-01	OC (over current) OCA (over current in ACC.) OCC (over current in constant speed)	Depend on parameter 07-02
07-02	OCd (over current in DEC) OL1 (motor overload) UT (Under torque detection) IPL (input phase loss)	
	GF (ground failure) OV (overvoltage) OL2 (Inverter overload) OT (Over-torque detection) OPL (Output phase loss) OH4 (motor overheat)	

Notes:

- Fault restart function contains momentary power loss restart and auto reset restart.
- Refer to chapter 10 for the details of troubleshooting and fault diagnostics.
- Refer to speed search function (07-19~07-24) for the selection of speed search modes.

Note:

Automatic restart function is only active in the state of no harm to the safety or to the application devices.

Warning - Excessively use of the automatic restart function will damage the inverter.

07-04	Direct Start at Power on
Range	【0】 : When the external run command is enabled, direct start at power up 【1】 : When the external run command is enabled, unable to direct start at power-up.

07-04=0,

If operation switch is conducted at power up, the inverter will start automatically.

07-04=1,

If operation switch is not conducted at power up, the inverter is not able to start and the warning signal of STP1 flashes. It is required to turn off the operation switch first, and then make it be conducted to start the inverter.

07-05	Delay of Direct Start at Power on
Range	【1.0~300.0】 Sec

If 07-04=0, it will count the delay time set by 07-05 first when the inverter starts directly at power on. When the delay time is completed, it starts to run.

! DANGER:

- **When 07-04=【0】 and the external run is set (00-02/ 00-03=1),**
If the operation switch is conducted at power up, the inverter starts automatically. It is suggested to turn off the power switch and operation switch at power failure to avoid the damage to the user or the machine when the inverter reconnects.
- **When 07-04=【1】 and the external run is set (00-02/ 00-03=1),**
If the operation switch is not conducted at power up, the inverter is not able to start and the warning signal of STP1 flashes. It is required to turn off the operation switch first and the delay time of direct start at power up is completed. Then make it be conducted to start the inverter.

07-06	DC injection braking starting frequency
Range	0.0~10.0 Hz

The braking act according to the different control modes, please refer to the following descriptions:

1. Control mode: VF、SLV and SLV2 (00-00 = 0、2、6)

It starts DC injection braking by the time 07-16. Deceleration to stop is according to 07-06 and 07-08. When output frequency is lower than 07-06 in deceleration time, it starts DC injection braking by the time 07-08.

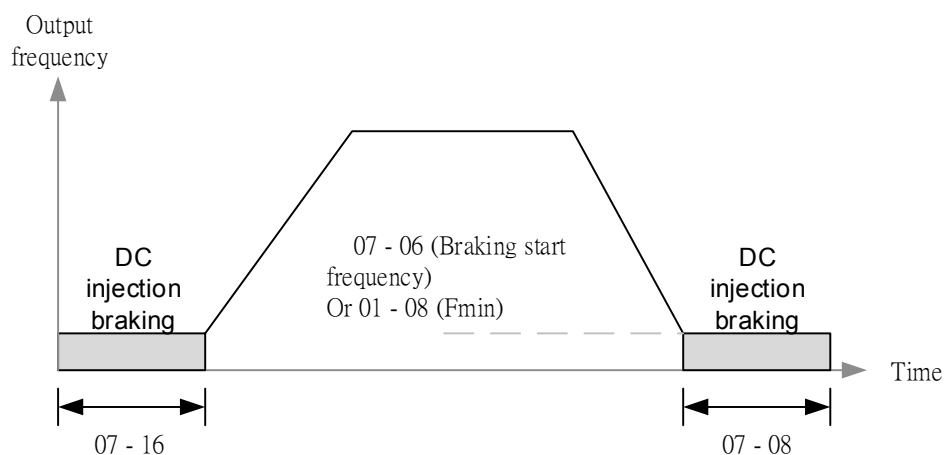

Figure 4.4.57a VF、SLV and SLV2 DC injection braking

Note: When 07-06 < 01-08, it starts DC injection braking by the setting frequency (01-08)

07-07	DC injection braking current
Range	0~100 %

DC Injection braking current as percentage of the inverter rated current. Increasing this level will increase the amount of heat generated by the motor windings. Do not set this parameter higher than the level necessary to hold the motor shaft.

07-08	DC injection braking time at stop
Range	0.00~10.00 Sec

Duration of DC injection braking during a stop operation. DC injection braking at stop is disabled when parameter 07-08 is set to 0 sec.

07-16	DC injection braking time at start
Range	0.00~10.00 Sec

Duration of DC injection braking is during a start operation. DC injection braking at start is disabled when parameter 07-16 is set to 0 sec.

DC Injection Braking Operation

When DC Injection braking is active DC voltage is applied to the motor, increasing the braking current and resulting in an increase in the strength of the magnetic field trying to lock the motor shaft.

To enable DC injection braking during a start operation set the DC injection braking current (07-07) and the DC injection braking time (07-16) at start to a value greater than 0. DC injection braking at start can be used to prevent “wind milling effect” in fan applications.

To enable DC injection braking during a stop operation set the DC injection braking current (07-07) and the DC injection braking time at stop (07-08) to a value greater than 0.

Notes:

- When parameter 07-16 is set to 0 sec (DC injection braking off). the inverter will start from the minimum output frequency.
- Increasing the DC braking time (07-08, 07-16) can reduce the motor stop time.
- Increasing the DC braking current (07-07) can reduce the motor stop time.
- During stop operation: If the DC braking start frequency < minimum output frequency (01-08), DC braking is activated when the output frequency reaches the minimum output frequency level.

For DC braking operation, please refer to Figure 4.4.57.

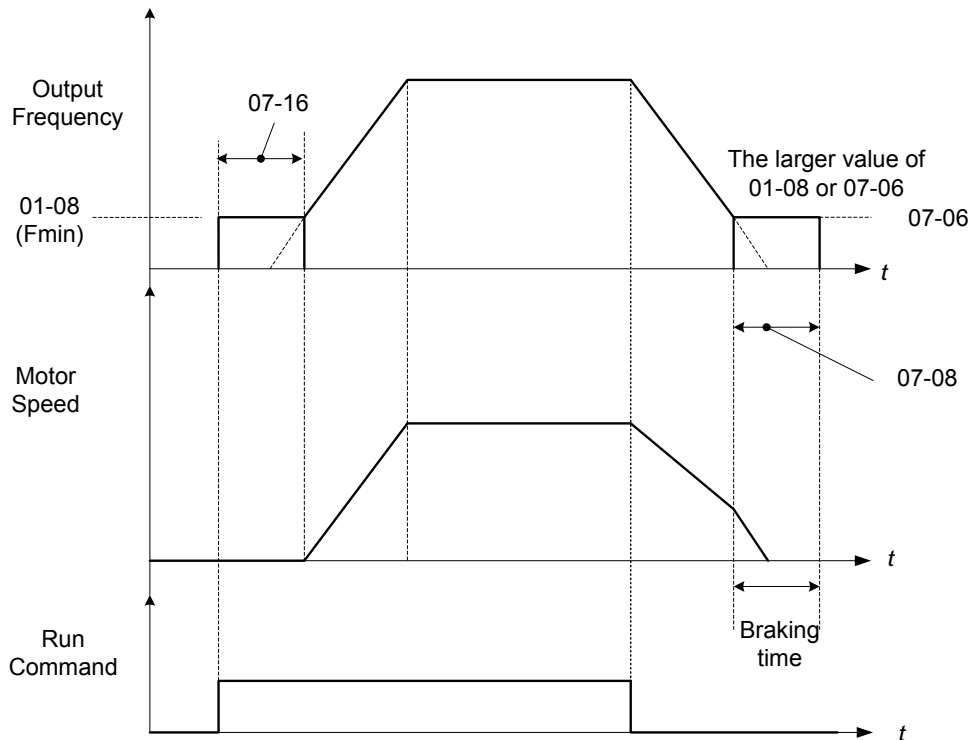

Figure 4.4.58 DC braking operation

DC braking operation can be controlled via any one of the multi-function input terminals (03-00 to 05) function 33. Refer to figure 4.4.58 for DC braking operation.

DC braking current can be controlled via the multi-function analog input (04-05) function 5. Refer to Figure 4.4.44.

07-09	Stop mode selection
Range	0: Deceleration to stop 1: Coast to stop 2: DC braking to stop 3: Coast to stop with timer

When a stop command is issued the inverter stops according to the stop mode selected. There are four types of stop modes,

07-09=0: Deceleration to stop

When a stop command is issued, the motor will decelerate to the minimum output frequency (01-08) F_{min} and then stop. Deceleration rate depends on the deceleration time (factory default: 00-15).

When the output frequency reaches the DC braking stop frequency (07-06) or the minimum output frequency (01-08), DC injection braking is activated and the motor stops.

$$\text{Deceleration time} = \frac{\text{Output frequency when stop command is issued}}{\text{Maximum output frequency } F_{max} \text{ (01-02)}} \times \text{deceleration time setting}$$

Note: S curve setting will add to the overall stop time

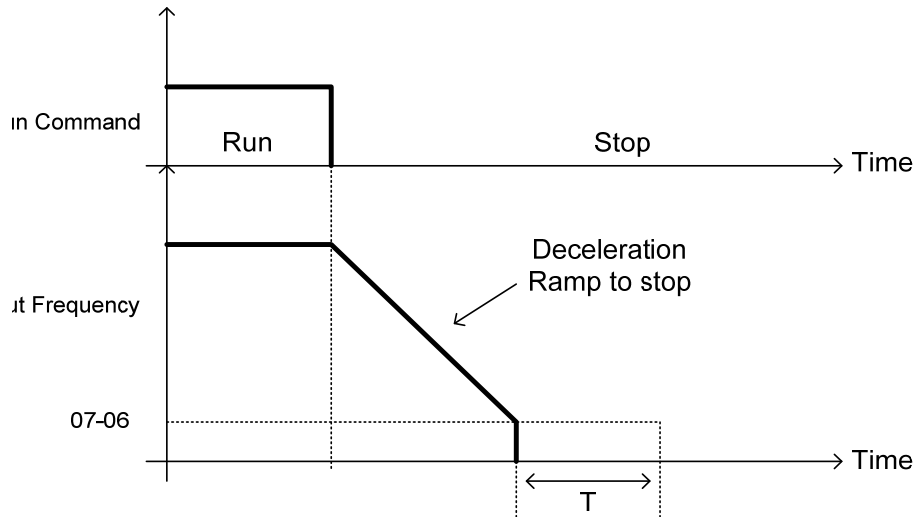

T: DC Braking Time at stop (07-08)

Figure 4.4.59 Deceleration to stop

07-09=1: Coast to stop

When a stop command is issued, the motor will coast to a stop. Stop time depends on motor load and friction of the system.

The inverter waits for the time set in the minimum baseblock time (07-18) before accepting the next run command.

In SLV mode (00-00=2) the speed search function is automatically enabled upon the next run command.

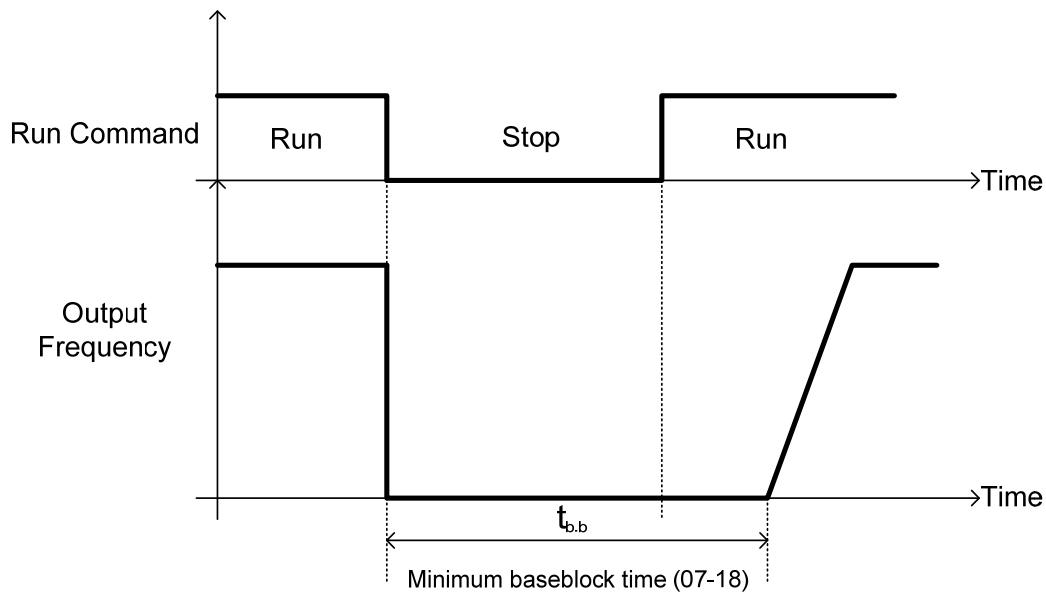

Figure 4.4.60 Coast to stop

07-09=2: DC braking to stop

When a stop command is issued, the inverter will turn off the output (Baseblock) and after the minimum Baseblock time (07-18) has expired activate DC braking (07-07). Refer to Figure 4.4.61.

The DC braking time (t_{DCDB}) of Figure 4.4.61 is determined by the value of 07-08 (DC Braking start time) and the output frequency at the time the stop command was issued.

$$t_{DCDB} = \frac{(07-08) \times 10 \times \text{output frequency}}{F_{max} (01-02)}$$

Note: Increase the minimum Baseblock time (07-18) in case an Overcurrent trip occurs during the DC braking.

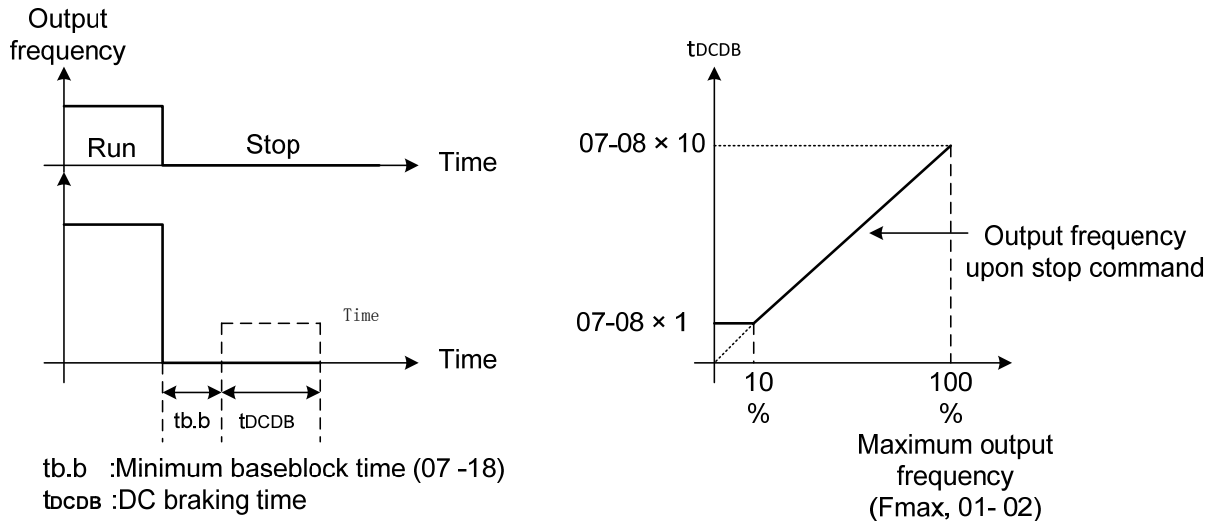

Figure 4.4.61 DC braking to stop

07-09=3: Coast to stop with timer

When a stop command is issued the motor will coast to a stop after the minimum Baseblock time (07-18) has expired. The inverter ignores the run command until the total time of the timer has expired.

The total time of the timer is determined by the deceleration time (00-15, 17, 22 or 24) and the output frequency upon stop. Refer to Figure 4.4.62

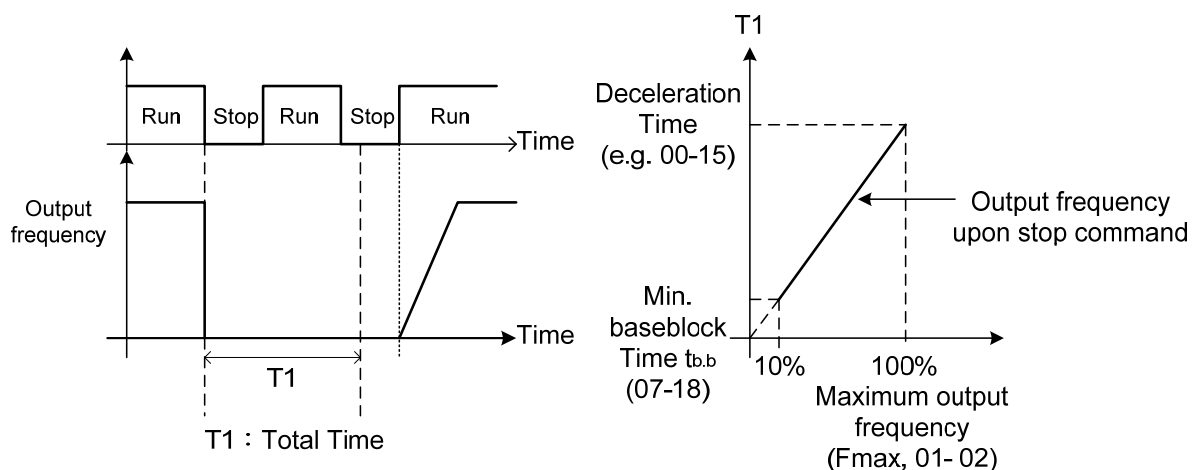

Figure 4.4.62 Coast to stop with timer

07-13	Low voltage detection level
Range	380V: 250~600Vdc

07-25	Low voltage detection time
Range	0.00~1.00 Sec

Adjust the 07-13 voltage level from from250 to 600 Vdc (380V class).

When the AC input voltage is lower than the 07-13 value (07-13/ 1.414 = AC voltage detection level) for the time specified in 07-25 the low-voltage error "UV" will displayed. If 07-25 = 0.00 sec., the UV error will be displayed immediately.

Set preventive measures:

- The inverter input voltage will limit the output voltage. If the input voltage drops excessively, or if the load is too big, the motor may stall.
- If the input voltage drops below the value set in 07-13 then the output is turned off momentarily. The inverter will not automatically start when power is restored.

07-14	Pre-excitation time
Range	0.00~10.00 Sec

07-15	Pre-excitation level
Range	50~200 %

If a high starting torque is required for the application, especially for a large horsepower motors, the pre-excitation operation can be used to pre-flux (magnetize) the motor.

Pre-excitation time (07-14)

When an operation command (forward or reverse) is activated, the inverter will automatically start pre-excitation based on the time set in parameter 07-14.

The time for the flux to reach 100% is a function value of motor's electrical time constant (See figure 4.4.63).

Electrical time constant (quadratic by-pass circuit time constant) can be calculated by motor parameter setting (group 02)

$$\text{Electrical time constant } T2 = \frac{\text{Motor leakage inductance (02-17) + motor mutual inductance (02-18)}}{\text{Motor rotor resistance (02-16)}}$$

Set the pre-excitation time (07-14) based on the electrical time constant T2

Pre-excitation initial level (07-15)

Use the pre-excitation initial level (07-15) to provide a higher excitation current during the pre-excitation time (07-14), which will increase the speed and stability for motors.

In order to quickly magnetize the motor, reduce the pre-excitation time (07-14) and set the pre-excitation level (07-15) to a high level.

If 07-15 is set greater than 100%, providing a high excitation current during the pre-excitation time (07-14), motor's magnetization time is shorted. When the setting reaches 200%, magnetization is reduced by roughly half.

A high pre-excitation level (07-15) might result in excessive motor sound during pre-excitation.

When the flux reaches 100%, pre-excitation current reverts back to 100% and pre-excitation is completed.

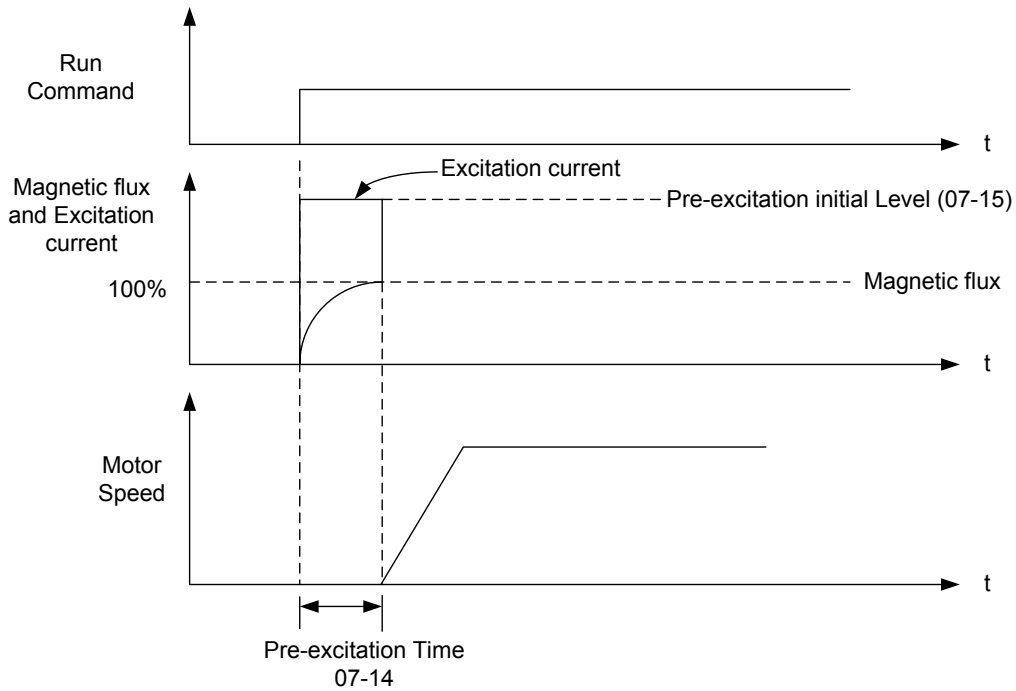

Figure 4.4.63 Pre-excitation operation

07-18	Minimum base block time
Range	0.1~5.0 Sec

In case of a momentary power failure, the inverter continues to operate after the power has been restored when parameter 07-00 is set to 1. Once the momentary power failure is detected; the inverter will automatically shut down the output and maintain B.B for a set time (07-18).

It is expected that after the minimum base block time has expired the residual voltage to be almost zero.

When the momentary power failure time exceeds the minimum base block time (07-18), the inverter will automatically perform a speed search upon return of power. Refer to the following figure 4.4.64.

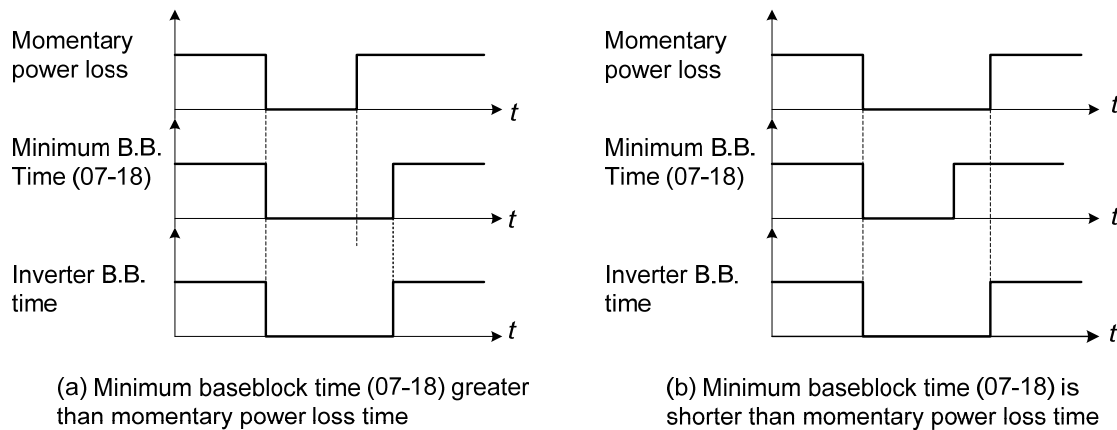

Figure 4.4.64 Minimum B.B time and momentary power loss time

Minimum base block time (07-18) is also used to for the DC braking function in combination with speed search as follows:

- Set the minimum base block time required (07-18).
- Execute speed search or DC braking function.
- Increase minimum Baseblock time if over-current "OC" condition occurs.
- After speed search is completed, normal operation continues.

07-19	Speed Direction Search Operating Current
Range	0~100 %

07-20	Speed Search Operating Current
Range	0~100 %

07-21	Integral time of speed searching
Range	0.1~10.0 Sec

07-22	Delay time of speed searching
Range	0.0~20.0 Sec
07-23	Voltage recovery time
Range	0.1~5.0 Sec
07-24	Direction-Detection Speed Search Selection
Range	0: Disable 1: Enable
07-26	SLV Speed Search Function
Range	0: Enable 1: Disable
07-27	Start Selection after fault during SLV mode
Range	0: Start with speed search 1: Normal start
07-28	Start after external base block
Range	0: Start with speed search 1: Normal start
07-32	Speed Search Mode Selection
Range	0: Disable 1: Mode1: Execute a Speed Search at Power On 2: Execute a Speed Search each time
07-33	Start Frequency of Speed Search Selection
Range	0: Maximum Output Frequency of Motor 1: Frequency Command

Speed search function is used to find the speed of a coasting motor and continue operation from that point. The speed search function is active after a momentary power loss.

Speed Search from Multi-function digital inputs

Set the multi-function digital input to external speed search command 1 or 2. External speed search command 1 (value = 19) and 2 (value = 34) cannot be set at the same time, otherwise "SE02" (digital input terminal error) warning occurs.

Speed search function must be enabled before applying the run command to ensure proper operation. See relay logic in figure 4.4.65.

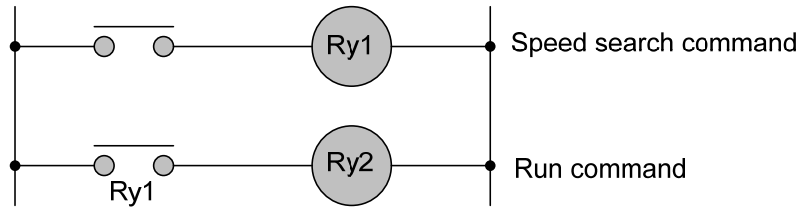

Figure 4.4.65 Speed search and operation commands

Notes: Speed Search Operation

- The speed search cannot be used when the motor rated power is greater than the inverter rated power.
- The speed search cannot be used when the motor rated power is two inverter sizes smaller than the inverter currently used.
- The speed search cannot be used in combination with a high-speed motor.
- If speed search function is used and the control mode is in V / F mode, it is necessary to perform a static auto-tune.
- If speed search function is used and the control mode is in SLV mode, it is necessary to perform a rotational auto-tune. Perform a static auto-tune when using long motor leads.

Speed search uses current detecting. Use parameter 07-24 to select detection direction.

07-19: Speed Direction Search Operating Current

- Used in bidirectional speed search only (07-24 = 1).
 - Set bidirectional current level.
 - Increase value if speed search is not successful at low speeds (above 5Hz)
- Note:** If value is too high may cause DC braking effect.

07-20: Speed Search Operating Current

- Can be used for bidirectional (07-24 = 1) or unidirectional (07-24 = 0) speed search.
- Sets speed search current Level.
- The set value must be lower than the excitation current (02-09) and must equal to the no-load current. If the no-load current is unknown it is recommended to set value at 20%.
- Excessive speed search current will cause inverter output to saturate.
- It is recommended to use speed search in case of a momentary power loss. Increase the minimum base block time (07-18) in case of an over-current condition.

07-21: Integral time of speed searching

- Can be used for bidirectional (07-24 = 1) or unidirectional (07-24 = 0) speed search.
- Set the integral time during speed search.
- If OV occurs, increase the set value to increase the speed search time. Decrease the value if a quick start is required

07-22: Delay time of speed searching

- Use delay time when using a contactor on the inverter output side.
- The inverter speed search starts after the delay time expires.

- Speed search delay time is disabled when set to 0.0 sec. (07-22 = 0.0)

07-23: Voltage recovery time

- Sets the voltage recovery time.
- Sets the time for the inverter to restore the output voltage from 0V to the specified V/f level after speed search function is completed.

07-24: Direction-Detection Speed Search Selection

0: Disable Direction-Detection Speed Search

Speed search is executed using speed search operating current defined in parameter 07-20. In case speed search is not successful (e.g. motor speed is too low) a speed search time-out warning is displayed. Set 07-19 to value greater than 0 to enable DC braking at speed search if a time-out occurs frequently.

1: Enable Direction-Detection Speed Search

At start the current controller will send a step current to the motor (07-19) to determine the motor direction. Once direction is determined the current controller will perform a speed search using speed search operating current defined in parameter 07-20. Speed search is executed after a momentary power loss (external speed search command 2, 03-00 to 03-05 = 34) or from max. frequency (external speed search command 1, 03-00 to 03-05 = 19). Speed search direction will follow the speed command.

07-26: SLV Speed Search Function

- In SLV mode (00-00 = 2) set the stop mode to the coast stop (07-09 = 1) or to the coast to stop with timer (07-09 = 3). After a stop command is issued (coast to stop or coast to stop with times) the speed search function is automatically activated for the next start.

0: Enable (No mechanical brake is installed)

1: Disable (Mechanical brake is installed)

07-27: Start Selection after fault during SLV mode

0: Speed search start: Speed search is executed after a fault in SLV mode.

1: Normal start: Speed search is not enabled.

Note: Set the parameter to 1 (normal start) after a fault has occurred and a mechanical brake is used to stop the motor.

07-28: Start after external Baseblock

0: Speed search start: Speed search is executed after base block is removed.

1: Normal start: Speed search is not enabled.

Note: Set parameter to 1 for control mode is V/F (00-00 = 0) or SLV mode (00-00 = 2) when the external base block active time is longer than the time the motor needs to come to a complete stop. After the external base

block command is removed the inverter will accelerate from min. frequency.

07-32: Speed Search Mode Selection

0: Disable: The inverter start to run from the lowest output frequency but it won't limit the other functions of trigger speed search.

1: Mode1: Execute a Speed Search at Power On: The inverter executes a speed search at power on when entering first run command. It start the motor from found frequency.

07-33: Start Frequency of Speed Search Selection

0: Maximum Output Frequency of Motor: The inverter start speed search from the maximum output frequency of motor.

1: Frequency Command: The inverter start speed search from setting frequency command.

■ Speed search based on current detection

(a) Speed search at starting

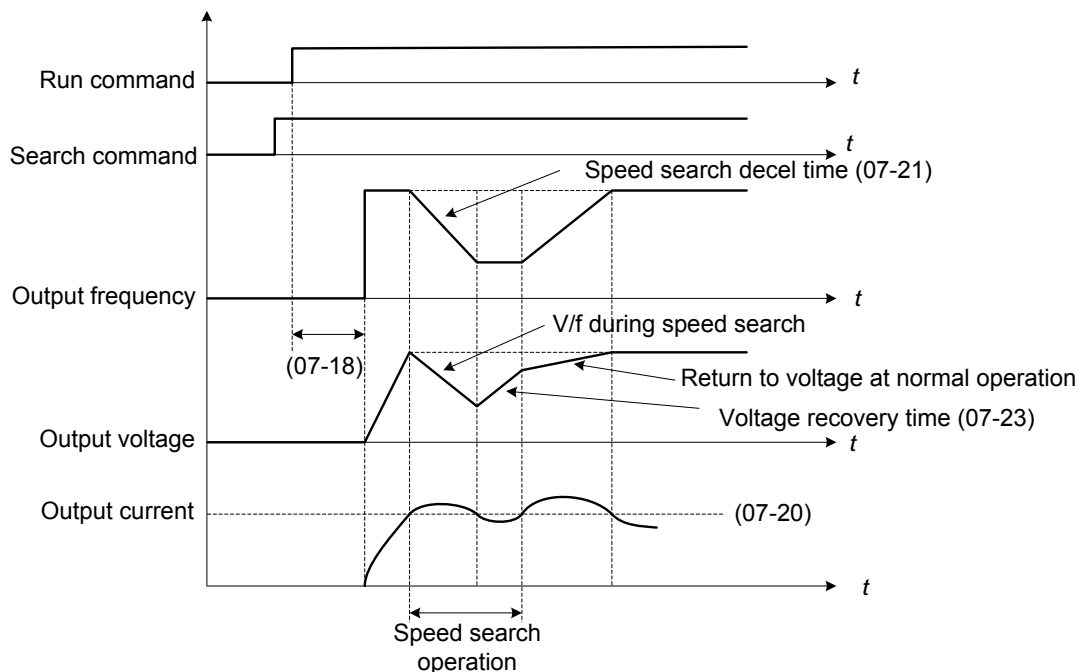

Figure 4.4.66 Speed search at starting

(b) Speed search in recovery period of momentary power failure

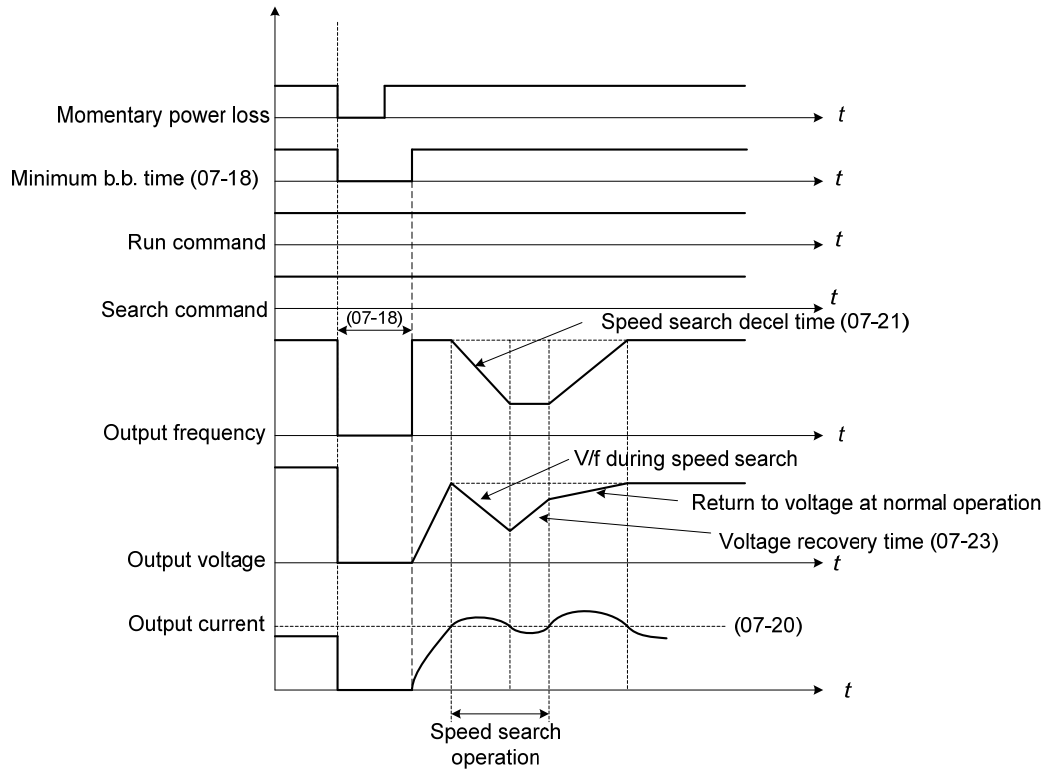

Figure 4.4.67 Speed search in recovery period of momentary power failure

Notes:

If the minimum base block time (07-18) is longer than the momentary power failure time, the speed search starts operation after the minimum base block time (07-18).

If the minimum base block time (07-18) is too short, the speed search operation begins immediately after power has been restored.

07- 29	Run Command Selection at the Action of DC Braking
Range	【0】 : Not Allowable to Run 【1】 : Allowable to Run

When DC braking is active, then:

07-29=0:

Inverter does not run again until DC braking stops.

07-29=1:

Inverter can run again even if DC braking is in action.

07- 42	Voltage Limit Gain
Range	【0.0~50.0】 %

When the output voltage saturation causes the abnormal motor running and then jittering, user can increase the set value of 07-42 to limit the output voltage.

When the value of 07-42 is set too large, insufficient torque may occur. User can decrease the set value to improve this situation.

08-Protection Parameters

08-00	Stall prevention function.
Range	xxx0b: Stall prevention function is enabled during acceleration. xxx1b: Stall prevention function is disabled during acceleration. xx0xb: Stall prevention function is enabled during deceleration. xx1xb: Stall prevention function is disabled during deceleration. x0xxb: Stall prevention function is enabled during operation. x1xxb: Stall prevention function is disabled during run. 0xxxb: Stall prevention function during run is based on the first acceleration time. 1xxxb: Stall prevention function during run is based on the second acceleration time.
08-01	Stall prevention level during acceleration
Range	20~200 %
08-02	Stall prevention level during deceleration
Range	380V: 660V~820V
08-03	Stall prevention level during run
Range	30~200 %
08-21	Limit of stall prevention during acceleration
Range	1~100 %
08-22	Stall prevention detection time during run
Range	2~100 msec
08-40	Motor2 Acceleration Stall Prevention Level
Range	20~200 %
08-41	Motor2 Acceleration Stall Prevention Limit
Range	1~100 %

Stall prevention during acceleration (08-00=xxx0b)

Prevents the inverter from faulting (Overcurrent, Motor overload, Inverter overload) when accelerating with heavy loads.

When the inverter output current reaches the level set in parameter 08-01 minus 15% the acceleration rate starts to decrease. When the inverter output current reaches the level set in parameter 08-01 the motor stops accelerating. Refer to figure 4.4.68 for more information.

Notes:

- Reduce stall prevention level during acceleration (08-01) in case the motor stalls (when the motor power is smaller than the inverter rating).
- The inverter rated output current should be set to 100%.

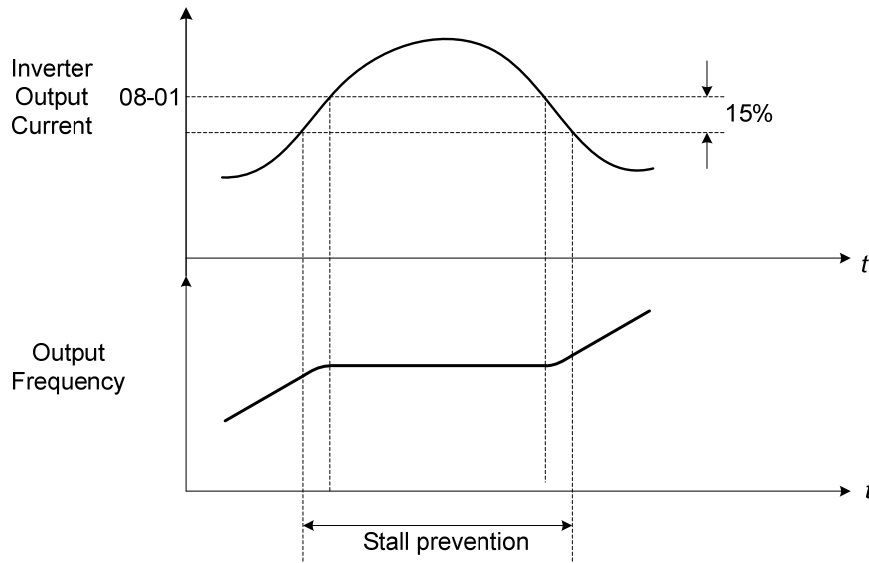

Figure 4.4.68 Stall prevention during acceleration

If the motor is used in the constant power (CH) region, the stall prevention level (08-01) is automatically reduced to prevent the stall.

Stall prevention level during acceleration (Constant horsepower)

$$\text{Stall Prev. Lev. Acceleration (CH)} = \frac{\text{Stall prevention level in acceleration (08-01)} \times \text{Fbase (01-12)}}{\text{Output frequency}}$$

Parameter 08-21 is the stall prevention limit value in Constant Horsepower region. Refer to figure 4.4.69.

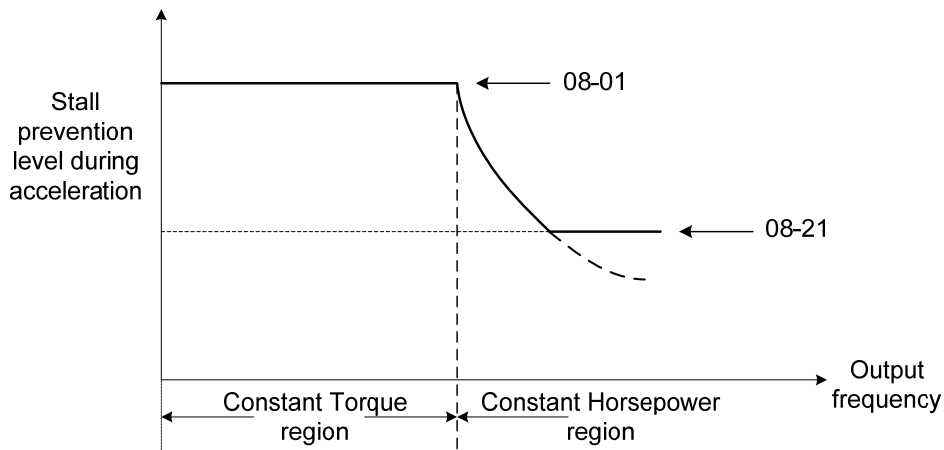

Figure 4.4.69 Stall prevention level and limit in acceleration

Motor2 Acceleration Stall Prevention Level (08-40) and Motor2 Acceleration Stall Prevention Limit (08-41) are Used when 03-00~03-05=40 (Switching between Motor 1/Motor 2)

Stall prevention selection during deceleration (08-00=xx0xb)

Stall prevention during deceleration automatically increases the deceleration time according based on the DC-bus voltage to prevent over-voltage during deceleration. Refer to Figure 4.4.69 for stall prevention during deceleration

When the DC-bus voltage exceeds the stall prevention level deceleration will stop and the inverter will wait for the DC-bus voltage to fall below the stall prevention level before continuing deceleration. Stall prevention level can be set by 08-02, see Table 4.4.34.

Table 4.4.34 Stall prevention level

Inverter model	08-02 default value
380V class	680/770VDC

Note: When using external braking (braking resistor or braking module) disable stall prevention during deceleration (08-00 to xx1xb).

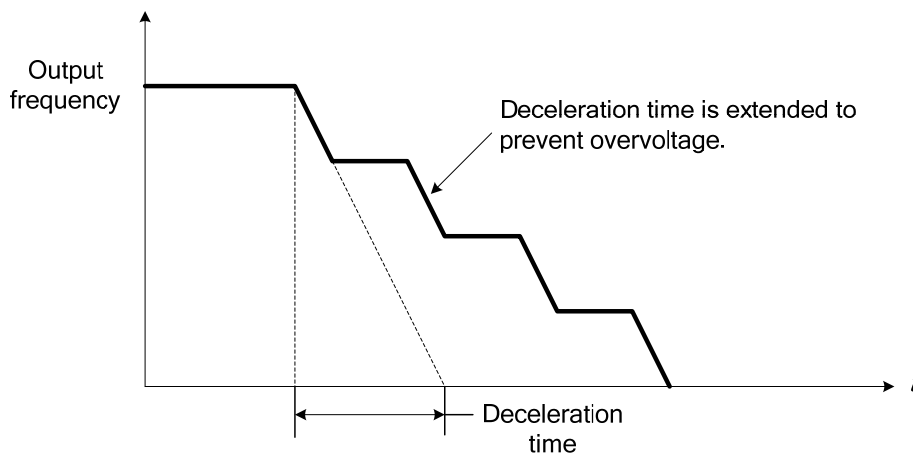

Figure 4.4.70 Stall prevention selection in deceleration

Stall prevention selection during run (08-00=x0xxb)

Stall prevention during run can only be used in V/F and SLV2 control mode.

This function prevents the motor from stalling by automatically reducing the output frequency during run.

If the inverter output current rises above the level set in parameter 08-03 for the time specified in parameter 08-22, the inverter output frequency is automatically decreased following deceleration time 1 (00-15) or deceleration time 2 (00-17).

When the inverter output current falls below the level set in parameter (08-03) minus 2%, normal operation continues and the output frequency increases to the frequency reference using the acceleration time 1 or acceleration time 2. Refer to the following figure 4.4.71.

Note: The stall prevention level during run can be set by using multi-function analog input AI2 (04-05=7).

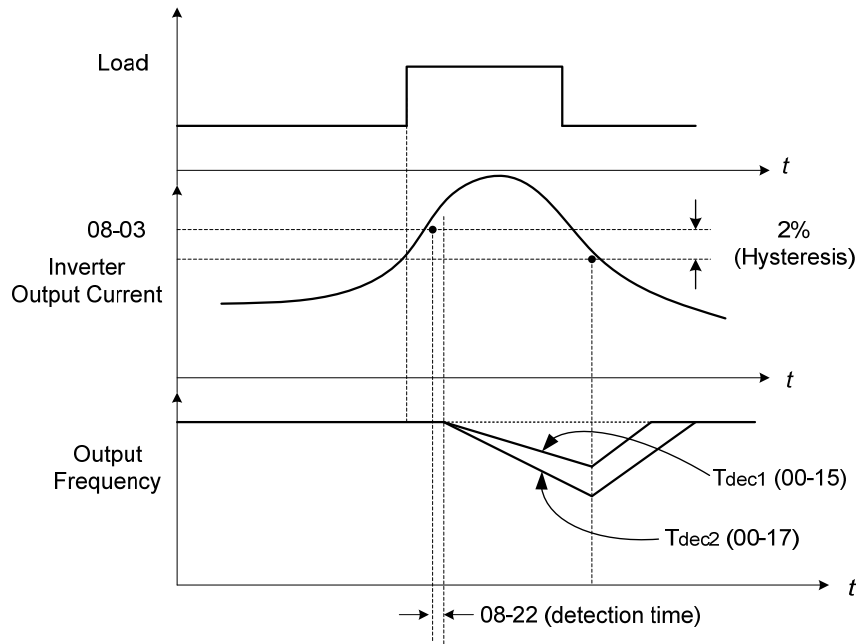

Figure 4.4.71 Stall prevention selection in operation

Note:

Stall prevention level in operation is set by multi-function analog input AI2 (04-05=7).

08-05	Selection for motor overload protection (OL1)
Range	xxx0b: Motor overload is disabled xxx1b: Motor overload is enabled xx0xb: Cold start of motor overload xx1xb: Hot start of motor overload x0xxb: Standard motor x1xxb: Special motor 0xxxb: Reserved 1xxxb: Reserved
08-07	Motor Overload (OL1) Protection Level
Range	[0] : Motor Overload (OL1) Protection 0 [1] : Motor Overload (OL1) Protection 1 [2] : Motor Overload (OL1) Protection 2

The motor overload protection function estimates the motor overload level based on the output current, output frequency, motor characteristics and time. The motor overload trip time depends on the motor rated current when the output frequency is greater than 60Hz.

On inverter power-up the motor overload protection internal thermal accumulation register is automatically reset.

To use the built-in motor overload protection function parameter 02-01 (motor rated current) has to match the motor rated current on the motor nameplate.

Turn off the motor overload protection when using two or more motors connected to the inverter (set 08-05 = xxx0b), and provide external overload protection for each motor (e.g. thermal overload switch).

With cold start enabled (08-05 = xx0xb), motor overload protection occurs in 5 and a half minutes when operating the motor at 150% of the motor rated current at an output frequency greater than 60Hz.

With hot start enabled (08-05 = xx1xb), motor overload protection occurs in 3 and a half minutes when operating the motor at 150% of the motor rated current at an output frequency greater than 60Hz.

Refer to the following figure 4.4.72 for an example of motor overload protection standard curve. And refer to the setting of 08-07 (Motor overload (OL1) protection level), the overload curve will be different.

08-07=0:

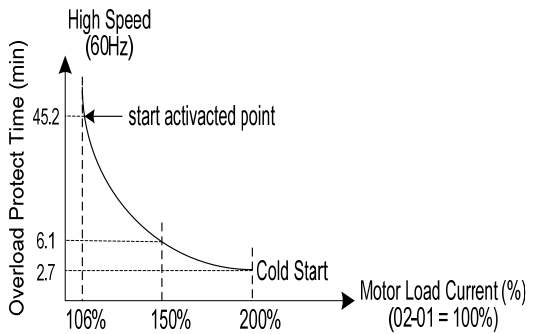
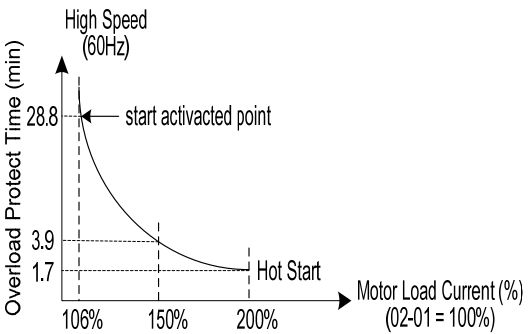
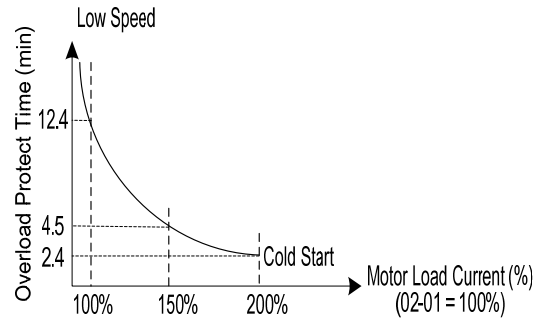
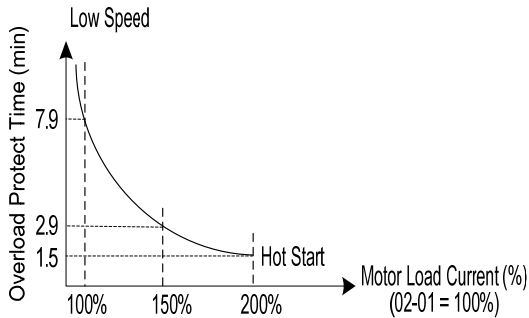

08-07=1:

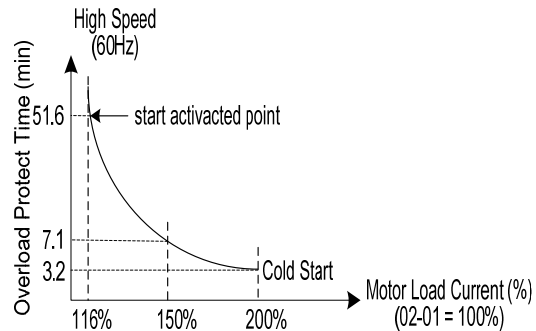
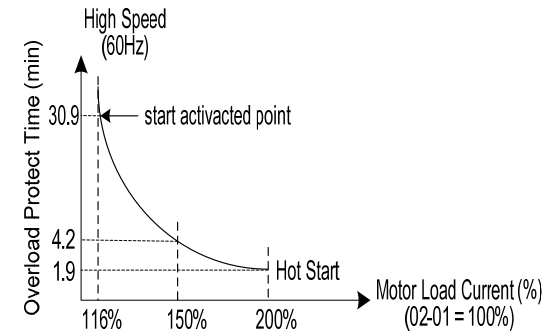
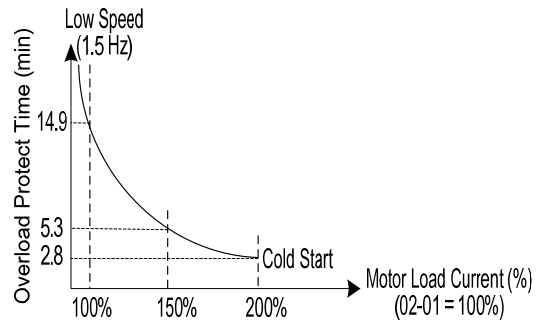
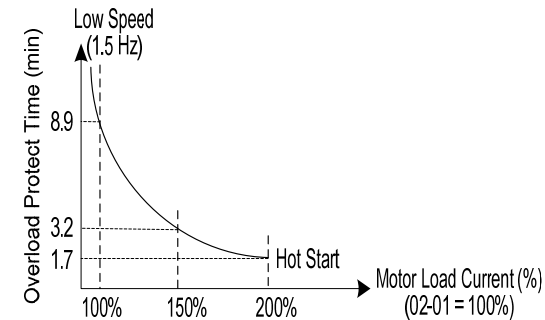

08-07=2:

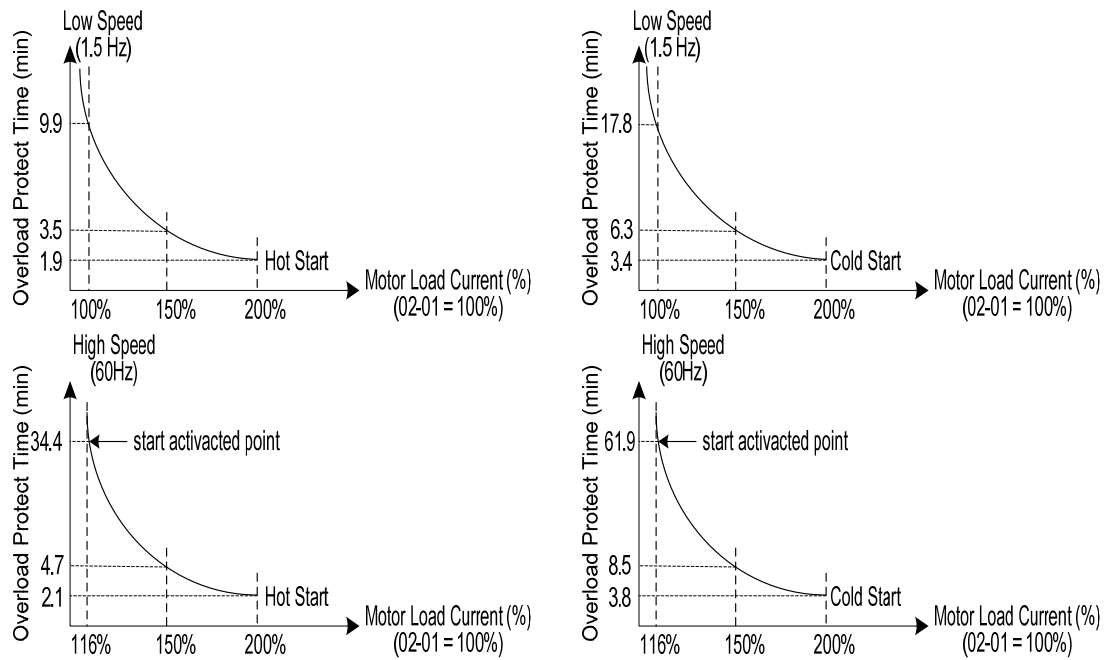

Figure 4.4.72 Motor overload protection curve (example: standard motor)

When using force cooled motors (Special inverter motor), thermal characteristics are independent of the motor speed, set 08-05 = x1xxb.

When 08-05 = x1xxb, overload protection function is based on motor rated current for output frequencies between 6 and 60Hz. If the output frequency is lower than 1Hz, the overload protection function uses 83% of the motor rated current to determine an overload condition.

When 08-05 = x0xxb, overload protection function is based on 70% of the motor rated current for an output frequency of 20Hz. If the output frequency is lower than 1Hz, the overload protection function uses 40% of the motor rated current to determine an overload condition.

Motor overload rating at different output frequencies is shown at Figure 4.4.73.

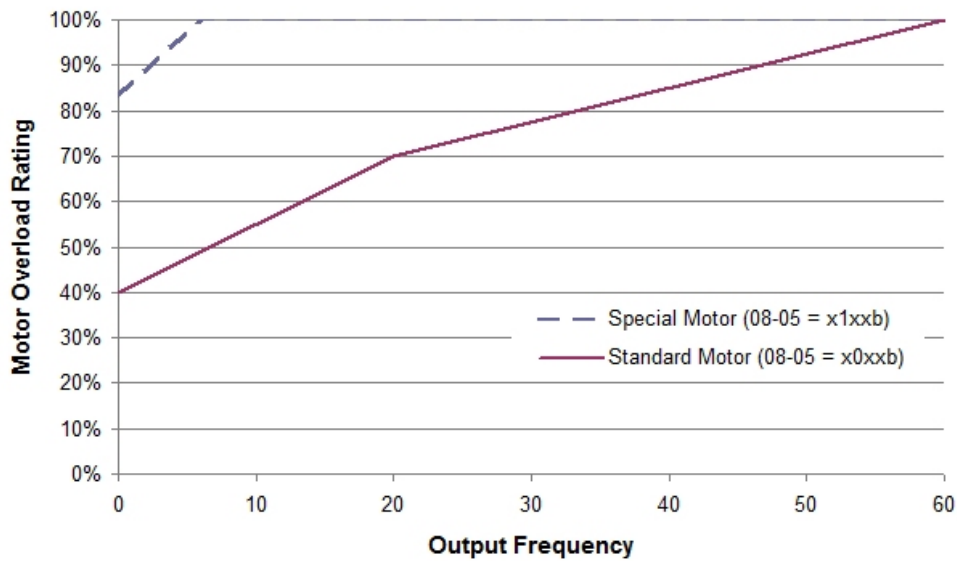

Figure 4.4.73 Motor overload rating at different output frequencies

08-06	Start-up mode of overload protection operation (OL1)
Range	0: Stop output after overload protection 1: Continuous operation after overload protection.

08-06=0: When the inverter detects a motor overload the inverter output is turned off and the OL1 fault message will flash on the keypad. Press RESET button on the keypad or activate the reset function through the multi-function inputs to reset the OL1 fault.

08-06=1: When the inverter detects a motor overload the inverter will continue running and the OL1 alarm message will flash on the keypad until the motor current falls within the normal operating range.

08-08	Automatic voltage regulation (AVR)
Range	0: AVR is enabled 1: AVR is disabled

Automatic voltage regulation stabilizes the motor voltage independent of fluctuation to the input voltage.

08-08=0: Automatic voltage regulation is active. It will limit the maximum output voltage. When input three-phase voltage fluctuates and the voltage is smaller than the value of 01-14, the output voltage will fluctuate with the fluctuation of input voltage.

08-08=1: Automatic voltage regulation is not active, motor voltage follows the input voltage fluctuation. When input three-phase voltage fluctuates, the output voltage won't fluctuate with the fluctuation of input voltage.

08-09	Selection of input phase loss protection
Range	0: Disable 1: Enable

08-09=0: Input phase loss detection is disabled.

08-09=1: Input phase loss detection is enabled. Keypad shows "IPL input Phase Loss" (IPL), when an input phase loss is detected the inverter output is turned off and the fault contact is activated.

Note: The input phase loss detection is disabled when the output current is less than 30% of the inverter rated current.

08-10	Selection of output phase loss protection
Range	0: Disable 1: Enable

08-10=0: Output phase loss detection is disabled.

08-10=1: Output phase loss detection is enabled. Keypad shows OPL, when an output phase loss is detected and the inverter output is turned off and the fault contact is activated.

Note: The output phase loss detection is disabled when the output current is less than 10% of the inverter rated current.

08-13	Selection of over-torque detection
Range	0: Over-torque detection is disabled 1: Start to detect when reaching the set frequency 2: Start to detect when the operation is begun

08-14	Selection of over-torque action
Range	0: Deceleration to stop when over-torque is detected. 1: Displays warning when over-torque is detected. Continue operation. 2: Coast to stop when over-torque is detected

08-15	Level of over-torque detection
Range	0~300 %

08-16	Time of over-torque detection
Range	0.0~10.0 Sec

08-17	Selection of low-torque detection
Range	0: Low-torque detection is disabled 1: Start to detect when reaching the set frequency 2: Start to detect when the operation is begun

08-18	Selection of low-torque action
Range	0: Deceleration to stop when low-torque is detected 1: Display warning when low-torque is detected. Go on operation 2: Coast to stop when under-torque is detected

08-19	Level of low-torque detection
Range	0~300%

08-20	Time of low-torque detection
Range	0.0~10.0 Sec

The over torque detection function monitor the inverter output current or motor torque and can be used to detect increase in inverter current or motor torque (e.g. heavy load).

The low torque detection function monitor the inverter output current or motor torque and can be used to detect a decrease in inverter current or motor torque (e.g. belt break).

The torque detection levels (08-15, 08-19) are based on the inverter rated output current (100% = inverter rated output current) when operating the inverter in V/F control and motor output torque (100% = motor rated torque) when operating the inverter in SLV control.

Over-torque detection

Parameter 08-13 selects over-torque detection function. An over-torque condition is detected when the output current / torque rises above the level set in parameter 08-15 (Over-torque detection level) for the time specified in parameter 08-06 (Over-torque detection time).

08-13=0: Over-torque detection is disabled.

08-13=1: Over-torque detection is enabled when the output frequency reaches the set frequency.

08-13=2: Over-torque detection is enabled during running.

Parameter 08-14 selects the way the inverter acts when an over-torque condition is detected.

08-14=0: When an over-torque condition is detected the inverter displays and over-torque detection fault and the motor decelerates to a stop.

08-14=1: When an over-torque condition is detected the inverter displays an over-torque detection alarm and continues to run.

08-14=2: When an over-torque condition is detected the inverter displays and over-torque detection fault and the motor coasts to a stop

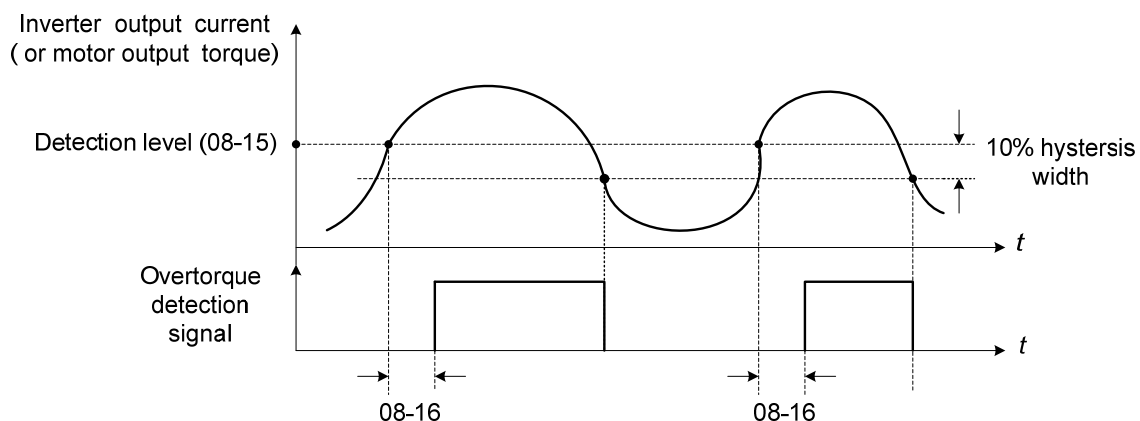

Figure 4.4.74 Over-torque detection operation

Low-torque detection

Parameter 08-18 selects low-torque detection function. An low-torque condition is detected when the output current / torque falls below the level set in parameter 08-19 (low-torque detection level) for the time specified in parameter 08-20 (Low-torque detection time).

08-17=0: Low-torque detection is disabled.

08-17=1: Low-torque detection is enabled when the output frequency reaches the set frequency.

08-17=2: Low-torque detection is enabled during running.

Parameter 08-18 selects the way the inverter acts when an over-torque condition is detected.

08-18=0: When a low-torque condition is detected the inverter displays and low-torque detection fault and the motor decelerates to a stop.

08-18=1: When a low-torque condition is detected the inverter displays a low-torque detection alarm and continues to run.

08-18=2: When a low-torque condition is detected the inverter displays and low-torque detection fault and the motor coasts to a stop

. Setting Example of less torque detection:

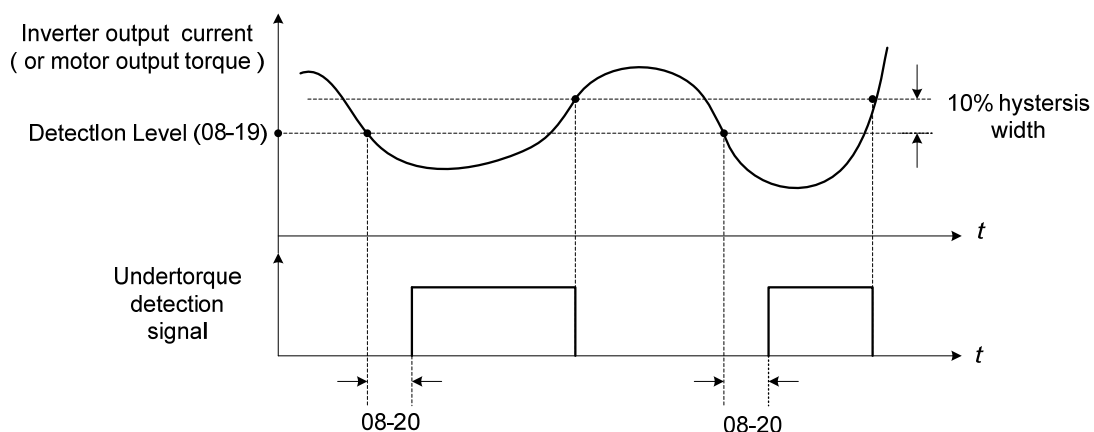

Figure 4.4.75 Low torque detection operation

Over and low torque detection condition can be output to the multi-function digital outputs (R1A-R1C, R2A-R2C) by setting parameters 03-11 to 03-12 to 12 or 25. Refer to figure 4.4.76 for more information.

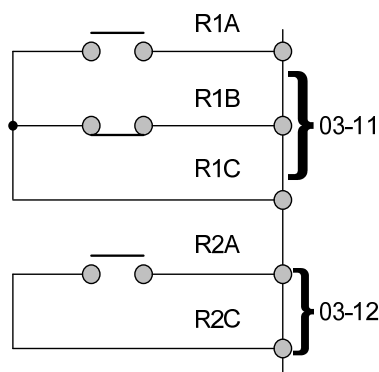

Figure 4.4.76 Over-torque / low torque detection multi-function digital output terminal

08-23	Ground Fault (GF) selection
Range	0: Disable 1: Enable

08-23=1:

If the inverter leakage current is greater than 50% of inverter rated current and the ground fault function is enabled (08-23), the keypad will display "GF ", motor will coast to a stop and fault contact is activated.

08-24	External Fault Operation Selection
Range	0: Deceleration to stop 1: Coast to stop 2: Continue operation

Select operation selection when an external fault occurs. Refer to the multi-function inputs on how to set up the inverter for an external fault input.

08-25	Detection selection of external fault
Range	0: Immediately detect when the power is supplied 1: Start to detect during operation

08-25=0: When the inverter is supplied by power, detection external fault function will execute.

08-25=1: When the inverter is start to run, detection external fault function will execute.

08-30	Run Permissive Function Selection
Range	0: Deceleration to Stop 1: Coast to Stop

When 03-00~03-05=58, the inverter will stop by the set of 08-30

08-37	Fan Control Function
Range	0: Start in operation 1: Permanent Start 2: Start in high temperature (except of the models of 2050, 4100 or the above)
08-38	Delay Time of Fan Off
Range	0~600 sec

08-37=0: The inverter start to run and the fan will follow to run. If the inverter stop and the time is longer than the value of 08-38, the fan stop. If the temperature for heat sink is higher than the temperature of inside-detection and the inverter doesn't run, the fan will start run automatically.

08-37=1: The inverter is supplied by power, the fan start to run.

08-37=2: The temperature for heat sink is higher than the temperature of inside-detection, the fan start to run. After the temperature for heat sink is lower than the temperature of inside-detection and the time is over 08-38, the fan stop.

08-35	Motor Overheat Fault Selection
Range	0: Disable 1: Deceleration to Stop 2: Free Run to top 3: Continue Running
08-36	PTC Input Filter Time Constant
Range	0.00 ~ 5.00 sec
08-39	Delay Time of Motor Overheat Protection
Range	1~300 sec
08-42	PTC Protection Level
Range	0.1~10.0V
08-43	PTC Restart Level
Range	0.1~10.0V
08-44	PTC Warning Level
Range	0.1~10.0V

Motor Overheat Fault Selection

It execute motor overheat protection by the resistor (PTC) that built-in the motor. the resistor (PTC) is between AI2 and GND and a divided resistor R ,as the pic 4.3.65(b)

08-35=0: Motor overheats fault function is off.

08-35=1: When the motor is overheating, it decelerates to stop.

08-35=2: When the motor is overheating, it free runs to stop.

08-35=3: When the motor is overheating, it does not stop running until reach the value of 08-42.

08-35=1 、 2: When the temperature is getting higher for the motor and AI2 voltage level is higher than the value of 08-44, the display will show 『OH4』 and the motor will stop by 08-35=1 、 2.

08-35=3: When the temperature is getting higher for the motor and AI2 voltage level is higher than the value of 08-44, the display will show 『OH3』 but the motor continues running. But AI2 voltage level is higher than the value of 08-42 and the time reach to 08-39, the motor free runs to stop.

08-35=1 、 2 、 3: When the motor cools down and AI2 voltage level is lower the value of 08-43, 『OH4』 will reset.

Note: The resistor (PTC) conform the British Standards Institution:
When Tr is 150 °C in Class F and is 180°C in Class H ◦

Tr- 5°C : $RT \leq 550\Omega$, put the value of RT in formula (1), the V value by calculation is the value of 08-43.

Tr+ 5°C : $RT \geq 1330\Omega$, put the value of RT in formula (1), the V value by calculation is the value of 08-44.

It gets reference value by using formula (1) even in the different spec of resistor (PTC).

$$V = \frac{1}{2} \times 10 \times \frac{R_{PTC} // 200}{R + (R_{PTC} // 200)} \text{ ----- Formula (1)}$$

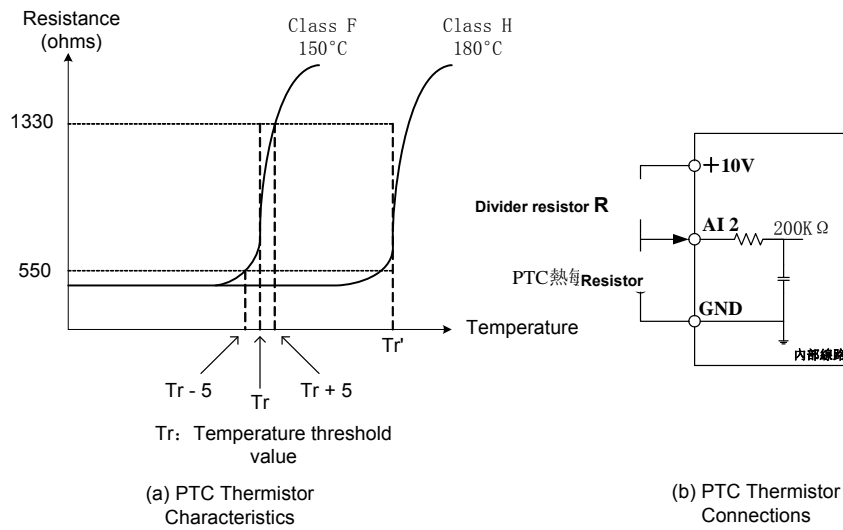

Pic 4.3.65 (a) PTC Thermistor Characteristics (b) PTC Thermistor Connections

09-Communication Parameters

09-00	INV Communication Station Address
Range	1~31
09-02	Baud rate setting (bps)
Range	0: 1200 1: 2400 2: 4800 3: 9600 4: 19200 5: 38400
09-03	Stop bit selection
Range	0: 1 stop bit 1: 2 stop bits
09-04	Parity selection
Range	0: No Parity 1: Even bit 2: Odd bit
09-05	Communication Data Bit Selection
Range	0: 8 Bit Data 1: 7 Bit Data
09-06	Communication error detection time
Range	0.0~25.5 Sec
09-07	Fault stop selection
Range	0: Deceleration to stop based on deceleration time 1. 1: Coast to stop when communication fault occurs. 2: Deceleration to stop based on deceleration time 2 3: Keep operating when communication fault occurs.
09-08	Comm. fault tolerance count
Range	1~20
09-09	Waiting time
Range	5~65 msec

The Modbus communication port RJ45 (S+, S-) can be used to monitor, control, program and trouble-shoot the inverter.

Modbus communication can perform the following operations, independent of the frequency command selection (00-05) setting and Operation command selection (00-02) setting:

- Monitor inverter signals
- Read and write parameters.
- Reset fault
- Control multi-function inputs

Modbus (RS-485) communication specification:

Items	Specification
Interface	RS-485
Communication type	Asynchronous (start - stop synchronization)
Communication parameters	Baud rate: 1200, 2400, 4800, 9600, 19200 and 38400 bps Data Length: 8 bits (Fixed) Parity: options of none, even and odd bit. For even and odd selection stop bit is fixed at 1 bit.
Communication protocol	Modbus RTU / ASCII
Number of inverters	Maximum 31 units

Communication wiring and setup

- (1) Turn off power to the inverter.
- (2) Connect communication lines of the controller to the inverter (RJ45).
- (3) Turn power on.
- (4) Set the required communication parameters (09-00) via the keypad.
- (5) Turn off power to the inverter and wait until keypad is completely off.
- (6) Turn power on
- (7) Start communication between controller and inverter.

Modbus (485) communication architecture

- (1) Modbus communication configuration uses a master controller (PC, PLC), communicating to a maximum of 31 inverters.
- (2) The master controller is directly connected to the inverter via the RS-485 interface. If the master controller has a RS-232, a converter must be installed to convert signals to RS-485 to connect the master controller to the inverter.
- (3) A maximum 31 inverters can be connected to a network, following the Modbus communication standard.

Communication Parameters:

09-00: Inverter station addresses: Range 1-31

09-02: RS-485 communication baud rate setting

- = 0: 1200 bps (bits / second)
- = 1: 2400 bps
- = 2: 4800 bps
- = 3: 9600 bps
- = 4: 19200 bps
- = 5: 38400 bps

09-03: Stop bit selection

- = 0: 1 stop bit
- = 1: 2 stop bits

09-04: Parity selection of RS-485 communication

- = 0: No parity.
- = 1: even parity.
- = 2: odd parity.

09-05: Communication Data Bit Selection

- = 0: 8 bits data
- = 1: 7 bits data

09-06: RS-485 communication error detection time

09-07: Stop selection of RS-485 communication failure

- = 1: Deceleration to stop by deceleration time 00-15
- = 2: Coast to stop
- = 2: Deceleration to stop using the deceleration time of 00-26 (emergency stop time)
- = 3: Continue to operate (only shows a warning message, press the stop button to stop operation)

09-08: Comm. fault tolerance count

When the number of communication errors exceeds the value set in parameter 09-08 the inverter will display the comm. Fault alarm.

09-09: Wait time of inverter transmission (09-09).

Set the inverter response delay time. This is the time between the controller message and the start of the inverter response message. Refer to figure 4.4.77. Set the controller receive time-out to a greater value than the wait time parameter (09-09).

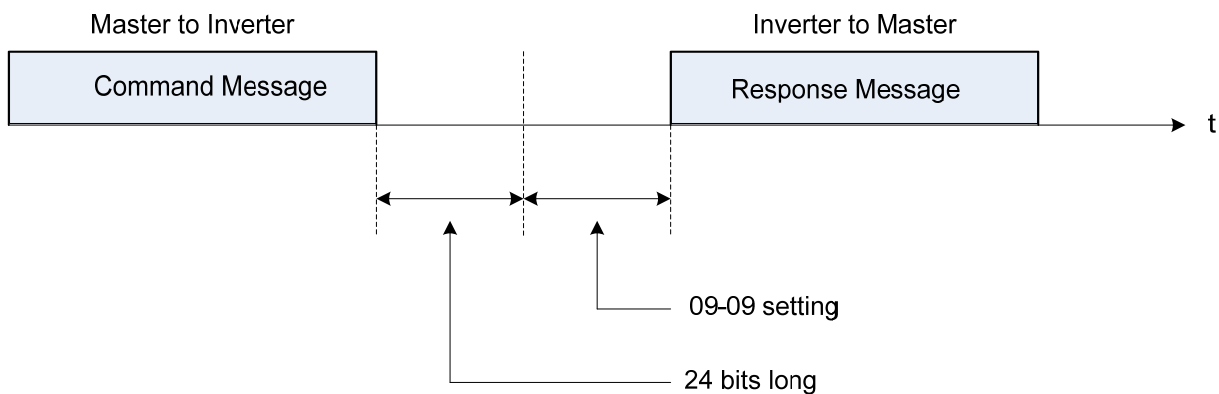

Figure 4.4.77 Communication Message Timing

10-PID Parameters

10-00	PID target value source setting
Range	1: AI1 given 2: AI2 given 3: Pulse given 4: Use 10-02 setting 5: Reserved 6: Frequency Command (00-05)

When 10-00=1 or 2,

Source of signal is proportional to be corresponding to PID target via analog input terminal.

For example:

0~10V is corresponding to 0~100% target value. When being given 2V, 20% target value is obtained.

When 10-00=3,

PID target value is pulse input. The proportion of pulse input is set depending on the parameters of 03-30 (pulse input scales) ~ 03-34 (pulse input filter time).

For general purpose of PID setting, set 10-00=4 to set the PID target value.

When 10-00=4

10-02(PID target value) is set at percentage and PID setting is at main screen monitor (12-38).

Maximum target value is set by parameter 10-33 (PID feedback maximum value), the decimals is determined by parameter 10-34 (PID decimal width), and the unit is set by parameter 10-35 (PID unit).

Ex:

Set 10-33 = 999, 10-34 = 1, 10-35 = 3, and set 10-02 to 10%

Then 9.9PSI is displayed at the main screen monitor (12-38) and can be modified at this monitor. Maximum value is 99.9 PSI (limited to the setting value of parameter 10-33).

When 10-00=6

The current frequency command is proportional to be corresponding to PID target.

10-01	PID feedback value source setting
Range	1: AI1 given 2: AI2 given 3: PI given

Note: Parameter 10-00 and 10-01 cannot be set to the same source. If both parameters are set to the same source the keypad will show a SE05 alarm.

10-02	PID target value
Range	0.00~100.00 %

10-03	PID control mode
Range	xxx0b: PID disable xxx1b: PID enable xx0xb: PID positive characteristic xx1xb: PID negative characteristic x0xxb: PID error value of D control x1xxb: PID feedback value of D control 0xxxb: PID output 1xxxb: PID output + Frequency Command

PID target value source setting(10-00/) PID feedback value source setting(10-01)

Please confirm parameter 04-00 conform the need (0V~10 V or 4mA~20 mA) if AI2 as PID target or PID feedback. And switch SW2 from control board to the input type (V or I), please refer to wiring diagram for more detail.

When 10-03= xxx1b: PID is enabled,

When 10-03= xx1xb: PID output is reverse. PID output is chosen to reverse, and if PID input is negative, the output frequency of PID will gain. On the contrary, PID output is chosen to forward, and if PID input is minus, the output frequency of PID will decrease.

Refer to Fig. 4.4.78 & 4.4.79 when **10-03= x1xxb:** feedback value differential of PID control and **10-03= x0xxb:** basic PID control

When 10-03= 0xxxb: PID output, it corresponds 100% to the frequency of 01-02. **When 10-03= 1xxxb:** PID output + frequency command, it will cumulate the output percentage of frequency command, (corresponding to 01-02 main frequency command set by parameter 00-05/ 00-06) at the beginning of running and then start PID control.

10-04	Feedback gain
Range	0.01~10.00

10-05	Proportional gain (P)
Range	0.00~10.00

10-06	Integral time (I)
Range	0.0~100.0 Sec

10-07	Differential time (D)
Range	0.00~10.00 Sec

10-09	PID bias
Range	-100~100 %

10-10	PID Primary delay time
Range	0.00~10.00 %

10-14	PID integral limit
Range	0.0~100.0 %

10-23	PID limit
Range	0.00~100.0 %

10-24	PID output gain
Range	0.0~25.0

10-25	PID reversal output selection
Range	0: Do not allow the reversal output 1: Allow the reversal output

10-26	PID target acceleration / deceleration time
Range	0.0~25.5 Sec

PID Adjustments

Gain control: The error signal (deviation) between the input command (set value) and the actual control value (feedback). This error signal or deviation is amplified by the proportional gain (P) to control the offset between the set value and the feedback value.

Integral control: The output of this control is the integral of the error signal (difference between set value and feedback value) and is used to minimize the offset signal that is left over from the gain control. When the integral time (I) is increased, the system response becomes slower.

Differential control: This control is the inverse from integral control and tries to guess the behavior of the error signal by multiplying the error with the differential time. The result is added to the PID input. Differential control slows down the PID controller response and may reduce system oscillation.

Note: Most applications that PID control (fan and pump) do not require differential control. Refer to Figure 4.4.78 for PID control operation

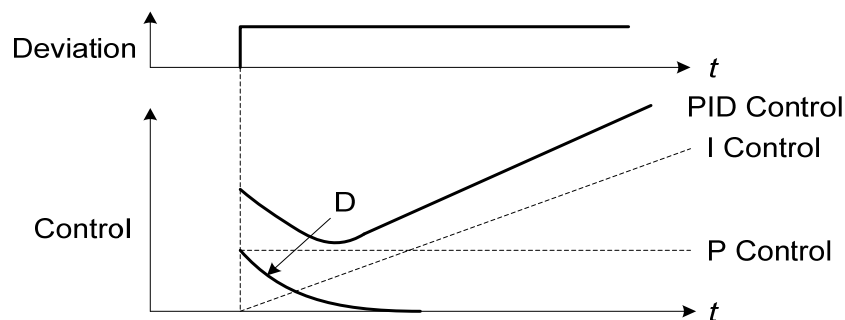

Figure 4.4.78 PID Control

PID Control Type

The inverter offers two types of PID control:

(a) **PID control with differential feedback:** (10-03 = x1xxb)

Make sure to adjust the PID parameters without causing system instability. Refer to Figure 4.4.79 for PID control for feedback value differential.

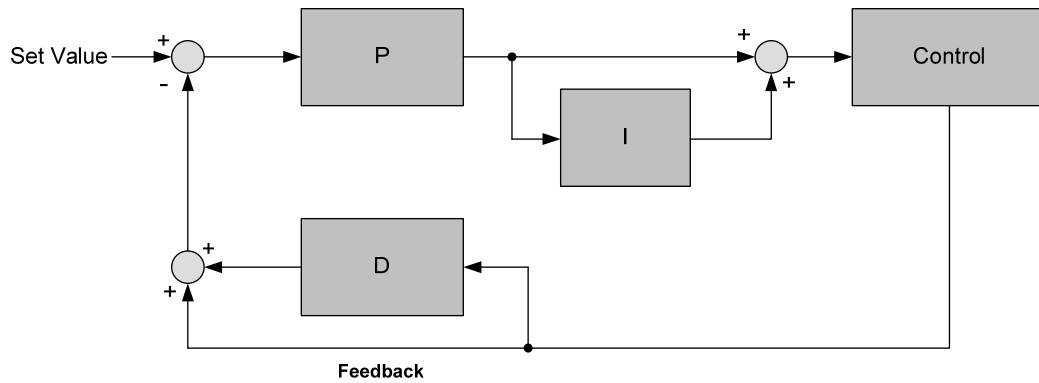

Figure 4.4.79 PID control for feedback differential value

(b) Basic PID control: (10-03 = x0xxb)

This is the basic type of PID control. Refer to the figure 4.4.80.

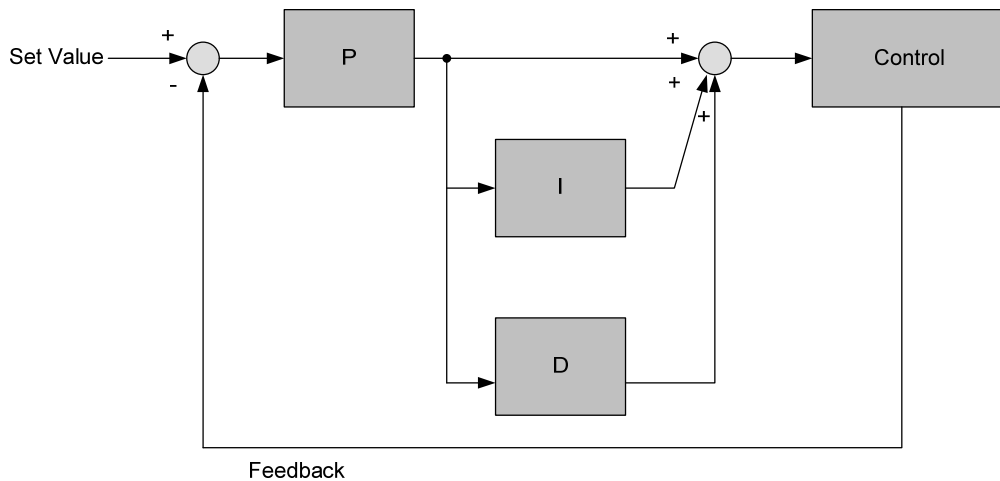

Figure 4.4.80 Basic PID control

PID Setup

Enable PID control by setting parameter 10-03, PID target value (10-00) and PID feedback value (10-01).

(1) Select PID target value (10-00):

10-00: PID target value

- =1: analog AI1 given (default)
- =2: analog AI2 given
- =3: Pulse given
- =4: 10-02
- =6 frequency command (00-05)

(2) Select PID feedback value (10-01):

10-01: PID feedback value

- = 1: Analog AI1 given
- = 2: Analog AI2 given
- =3: Pulse given

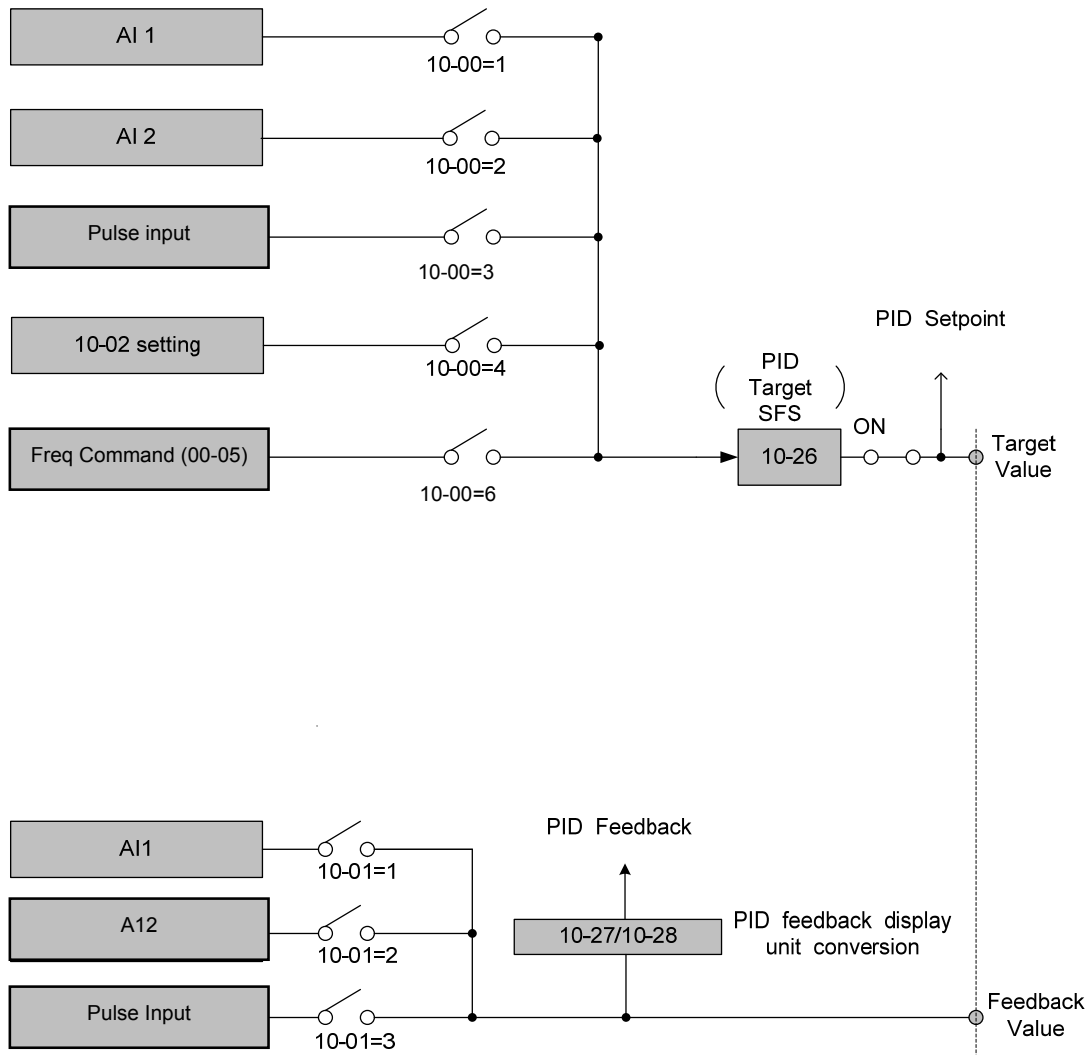

Figure 4.4.81 PID input selection

PID Control Setting

PID control block diagram.

The following figure shows the PID control block diagram.

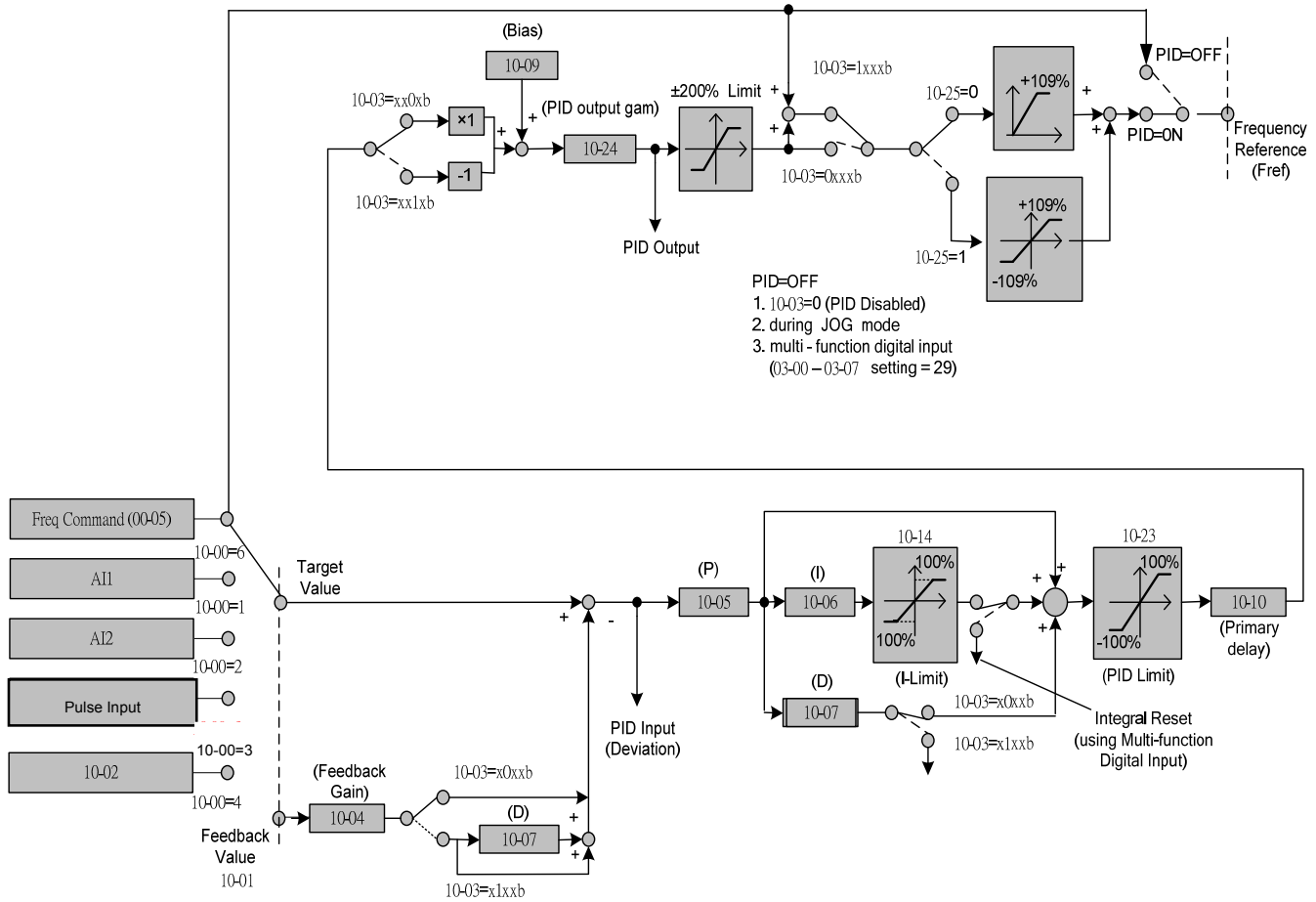

Figure 4.4.82 PID control block diagram

PID Tuning

Use the following procedures to start PID control,

- (1) Enable PID control (set 10-03 to a value greater than "xx0b").
- (2) Increase the proportional gain (10-05) to the highest value possible without causing the system to become unstable.
- (3) Decrease the integral time (10-06) to the lowest value possible without causing the system to become unstable.
- (4) Increase the differential time (10-07) to the highest value possible without causing the system to become unstable.

The PID control serves to maintain a given process within certain limits whether it is pressure, flow etc. To do this the **feedback** signal is compared to the **set value** and the difference becomes the error signal for the PID control.

The PID control then responds by trying to minimize this error. The error is multiplied times the value of the **Proportional gain** set by parameter **10-05**. An increased gain value results in a larger error. However, in any system as the gain is increased there is a point that the system will become unstable (oscillate).

To correct this instability, the response time of the system may be **slowed** down by increasing the **Integral time** set by parameter **10-06**. However slowing the system down too much may be unsatisfactory for the process.

The end result is that these two parameters in conjunction with the acceleration time (01-14) and deceleration (**01-15**) times require to be adjusted to achieve optimum performance for a particular application.

PID output polarity can be selected with parameter 10-03 (setting = xx0xb: PID output forward, setting = xx1xb: PID output reversal). When PID output is chosen to reverse, and if PID input is negative, the output frequency of PID will gain. On the contrary, PID output is chosen to forward, and if PID input is minus, the output frequency of PID will decrease.

PID feedback value can be adjusted using parameter 10-04 (PID feedback gain) as well as with the analog input gain and bias for terminal AI1 or AI2.

10-14: PID integral limit: Used to limit the integral output to prevent motor stall or damage to the system in case of a rapid change in the feedback signal. Reduce the value of 10-14 to increase the inverter response.

10-23: PID limit: Used to limit the output of the PID control. Maximum output frequency is 100%.

10-10: Primary delay time: Low pass filter situated after the PID limit block that can be used to prevent PID output resonance. Increase the time constant to a value greater than the resonance frequency cycle and reduce time constant to increase the inverter response.

10-09: PID bias: Used to adjust the offset of the PID control. The offset value is added to the frequency reference as compensation. Use parameter 10-24 (PID output gain) to control the amount of compensation.

In case the PID control output value goes negative, parameter 10-25 (PID reversal output selection) can be used to reverse the motor direction.

Note: The PID output remains at zero when reverse operation is disabled.

10-26: PID target SFS: Sets the PID target value acceleration and deceleration ramp time. The PID target SFS can be disabled by setting the multi-function digital inputs 03-00 ~ 03-05 to 36 (PID target SFS is off). Reduce the acceleration / deceleration time in case load resonance or system instability is encountered.

PID Fine Tuning

All PID control parameters are related to each other and require to be adjusted to the appropriate values. Therefore, the procedure achieving the minimum steady-state is shown as following:

- (1) Increase or decrease the proportion (P) gain until the system is stable using the smallest possible control change.
- (2) The integral (I) reduces the system stability which is similar to increasing the gain. Adjust the integral time so that the highest possible proportional gain value can be used without affecting the system stability. An increase in the integral time reduces system response.
- (3) Adjust the differential time if necessary to reduce overshoot on startup. The acceleration / deceleration time can also be used for the same purpose.

Fine-tuning PID control parameters:

- (1) Reduce overshoot

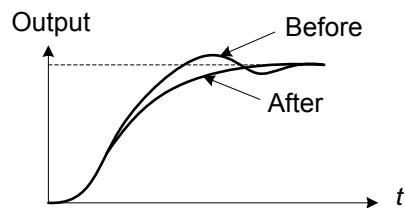

In case overshoot occurs, reduce the derivative time (D) and increase the integral time (I).

- (2) Stabilize PID control

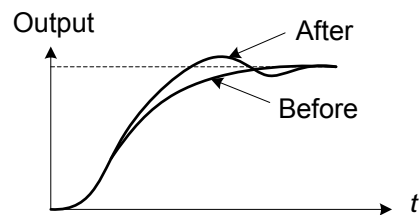

To quickly stabilize the PID control, reduce the integral time (I) and increase the differential time (D) in case overshoot occurs.

- (3) Reduce long-period oscillation

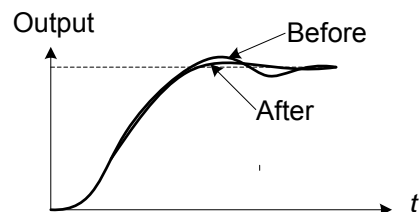

Adjust the integral time (I) in case of long-periodical system oscillation.

- (4) Reduce short-period oscillation

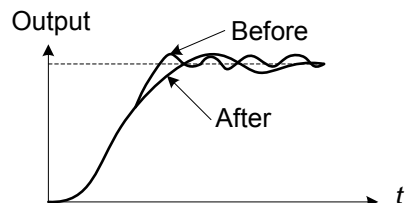

Adjusting the differential time (D) and proportional (P) gain when experiencing short-periodical oscillation.

10-11	PID feedback loss detection selection
Range	0: Disable 1: Warning 2: Fault
10-12	PID feedback loss detection level
Range	0~100 %
10-13	PID feedback loss detection time
Range	0.0~10.0 Sec

The PID control function provides closed-loop system control. In case PID feedback is lost, the inverter output frequency may be increase to the maximum output frequency.

It is recommended to enable to the PID feedback loss when the PID function is used.

PID feedback loss detection

10-11=0: Disable

10-11=1: Warning

A feedback loss condition is detected when the PID feedback value falls below the value set in parameter 10-12 (PID feedback loss detection level) for the time set in parameter 10-13 (PID feedback loss detection time). PID feedback loss warning message "Pb" will be displayed on the keypad and the inverter will continue to operate.

10-11=2: Fault

A feedback loss condition is detected when the PID feedback value falls below the value set in parameter 10-12 (PID feedback loss detection level) for the time set in parameter 10-13 (PID feedback loss detection time). PID feedback loss fault message "Pb" will be displayed on the keypad, the inverter stops and the fault contact is activated.

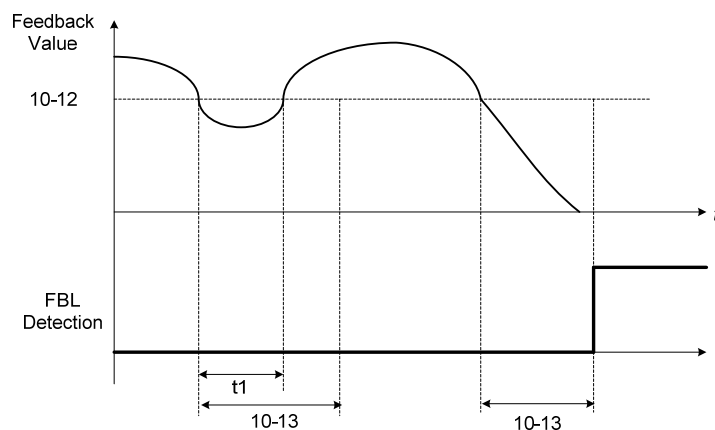

Figure 4.4.83 PID feedback loss detection

10-17	Start frequency of PID sleep
Range	0.00~599.00 Hz
10-18	Delay time of PID sleep
Range	0.0~255.5 Sec
10-19	Frequency of PID wakeup
Range	0.00~599.00 Hz
10-20	Delay time of PID wakeup
Range	0.0~255.5 Sec
10-29	PID sleep selection
Range	0: Disable 1: Enable 2: Set by DI
10-40	Selection of PID Sleep Compensation Frequency
Range	0: Disable 1: Enable

The PID Sleep function is used to stop the inverter when the PID output falls below the PID sleep level (10-17) for the time specified in the PID sleep delay time parameter (10-18).

The inverter wakes up from a sleep condition when the PID output (Reference frequency) rises above the PID wake-up frequency (10-19) for the time specified in the PID wake-up delay time (10-20).

Use parameter 10-29 to enable / disable PID sleep function.

10-29 =0: PID Sleep function is disabled.

10-29 =1: PID sleep operation is based on parameters of 10-17 and 10-18.

10-29 =2: PID sleep mode is enabled by multi-function digital input

Refer to figure 4.4.84 (a) and (b) for PID sleep / wakeup operation.

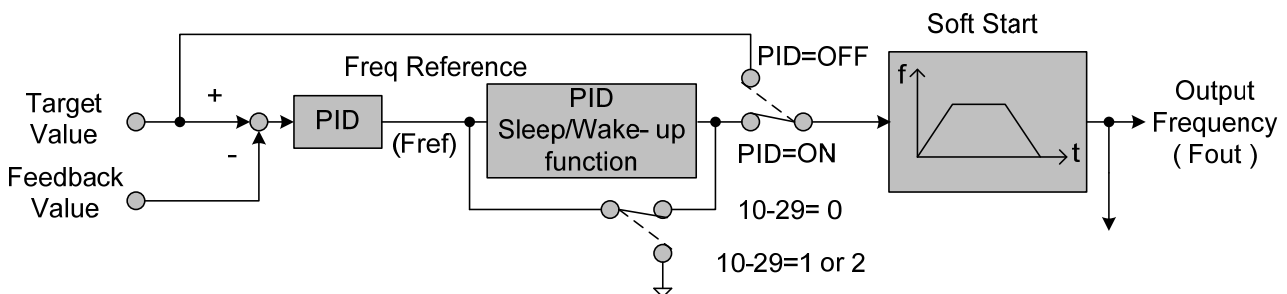

Figure 4.4.84: (a) PID control block diagram

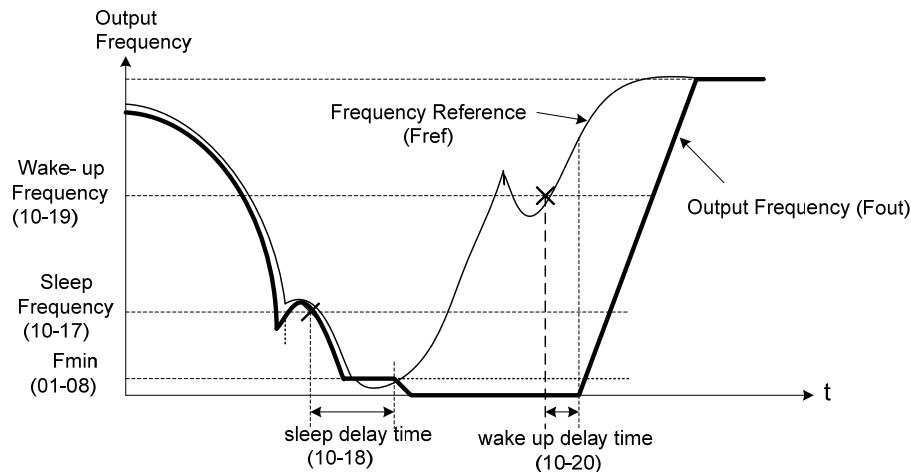

Figure 4.4.84: (b) Timing diagram PID sleep / wakeup

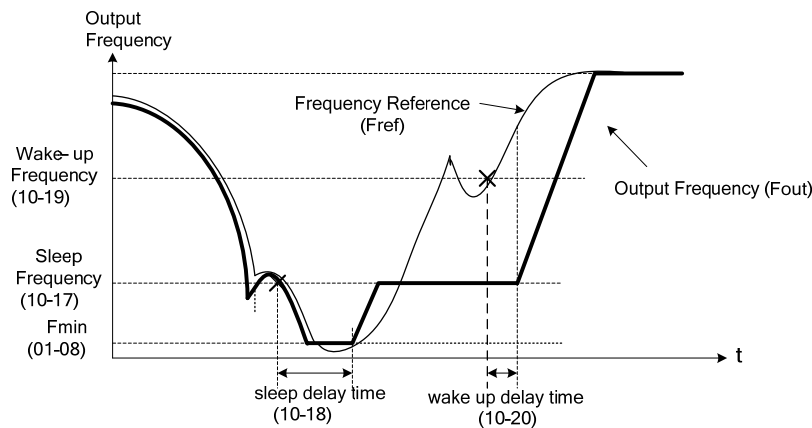

Figure 4.4.84: (c) Timing diagram of PID sleep compensation frequency/ wakeup

Notes:

10-40=0, refer to Figure 4.4.84 (b)

The PID sleep timer is enabled when the output frequency (Fout) falls below the PID sleep frequency (10-17). When the sleep timer reaches the set PID sleep delay time (10-18) the inverter will decelerate to a stop and enter the sleep mode.

10-40=1, refer to Figure 4.4.84 (c)

When output frequency (Fout) is lower than PID sleep frequency set by 10-17, Timer of PID sleep mode will run and the output frequency changes with the reference frequency (Fref) until it reaches the minimum output frequency (Fmin) set by 01-08. When the PID sleep delay time (10-18) is completed, the motor will run gradually to the PID sleep frequency set by 10-17.

Note: It should be used in the situation of being required the constant frequency.

While sleep mode is active and the motor has stopped, the internal PID control is still in operating. When the reference frequency increases and exceeds the wakeup frequency parameter 10-19 for the time specified in the wakeup delay time parameter 10-20, the inverter will restart and the output frequency will ramp up to the reference frequency.

Example:

-- When wakeup frequency < sleep frequency, inverter starts by the sleep frequency and sleeps depending on sleep frequency.

-- When wakeup frequency > sleep frequency, inverter starts by the wakeup frequency and sleeps depending on sleep frequency.

10-27	PID Feedback Display Bias
Range	0~9999

10-28	PID Feedback Display Gain
Range	0.00~100.00

PID Feedback Display Scaling

The PID feedback signal can be scaled to represent actual engineering units. Use parameter 10-28 to set the feedback signal gain for the feedback signal range maximum and parameter 10-27 to the feedback signal minimum.

Example:

Feedback signal is a pressure transducer (0-10V or 4-20mA) with a range of 1.0 – 20.0 PSI
4mA (0V) = 1.0 PSI, 20mA (10V) = 20.0 PSI.

Set parameter 10-27 to 1.0 minimum of transducer range (0%).
Set parameter 10-28 to 20.0 maximum of transducer range (100%).

Refer to the figure 4.4.85 for displaying the unit conversion.

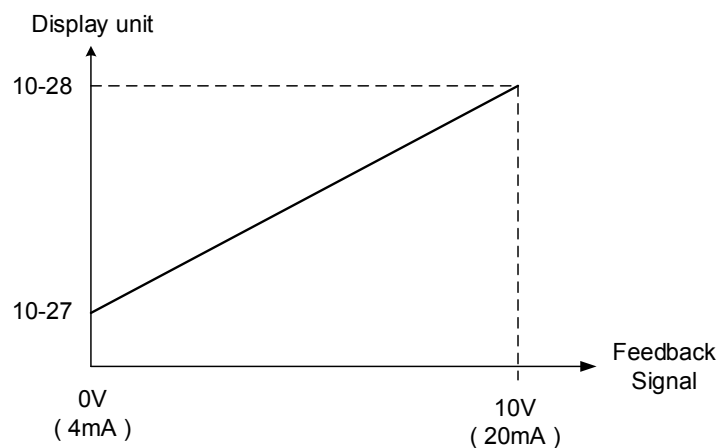

Figure 4.4.85 Feedback signal scaling

10-30	Upper Limit of PID Target
Range	0 ~ 100 %

10-31	Lower Limit of PID Target
Range	0 ~ 100 %

Target value of PID will be limited to the range of upper & lower limit of PID target.

10-33	Maximum Value of PID Feedback
Range	1~10000

When the maximum value of PID feedback is active, it will become 100% the corresponding value of 10-02.

10-34	PID Decimal Width
Range	0~4

PID decimal width is used for rounding up setting. For example: set 10-34=1, it displays XXX.X ; set 10-34=2, it displays XX.XX.

Note: When user switches PID in LED keypad, 10-33 is required to be lower than 1000 and 10-34=1, or the keypad will show a SE05 alarm (PID setting error).

10-39	Output Frequency Setting of PID Disconnection
Range	00.00~599.00 Hz

When PID feedback disconnection is in alarm, frequency command output depends on the setting value of 10-39. If the warning is lifted, PID control is restored.

10- 15	PID Trim Mode
Range	0~2
10- 16	PID Trim Scale
Range	0~100

10- 41	PID Mode Switch
Range	【0】 : General PID 【1】 : D Type PID

Signal Given and Process:

When 10-41= 1 (D type PID), T310 can process the ratio conversion for external signal, and then the signal given value can correspond to the speed command.

The Signal given corresponds to the speed command mode:

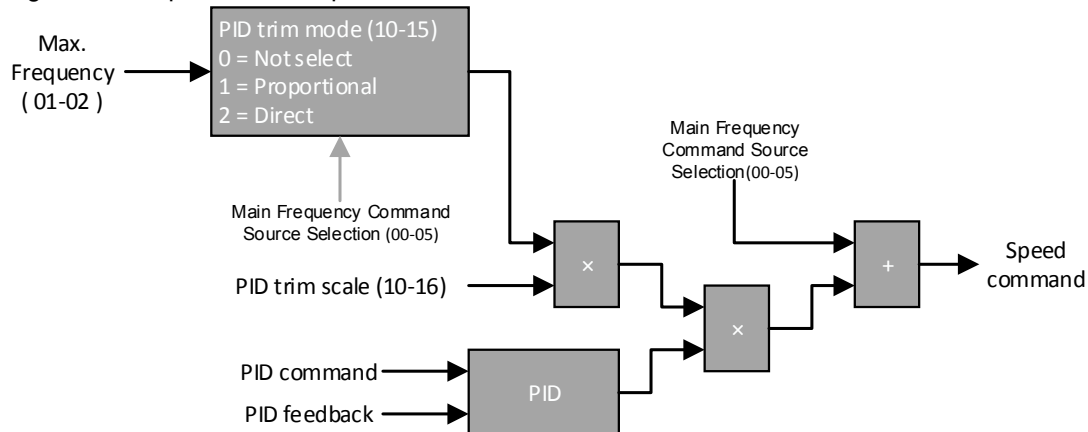

- Use the follow steps to start D type PID control:
 - (1) 10-03 (PID control mode) set to 1001b.
 - (2) 10-00 (PID target value source) set to 4 (10-02 given).
 - (3) 10-01 (PID feedback value source) set to 2 (AI2 given).
 - (4) 00-05 (Main frequency command source selection) set to 1 (External terminal: Analog 1).
 - (5) 10-29 PID sleep selection set to 0 (Disable).
- The maximum frequency limit is set by 10-08.
- 10-25 PID reversal output selection decide the output can or cannot reversal run.
- The first bit of 10-03 PID control mode decide to plus the frequency command.
- The response of PID control can be adjust 10-36 (Proportional gain 2), 10-37 (Integral Time 2) and 10-38 (Differential Time 2)
- 10-15 (PID trim mode) set to 1 (Proportional), use the multiple of 01-02 (Maximum output frequency of motor) and 01-12 (Base frequency of motor), then multiply the frequency of 00-05 (Main frequency command source selection), then multiply 10-16 (PID trim scale), the value can be used to modify the PID multiple.
- 10-15 (PID trim mode) set to 0 (Not select), use 01-02 (Maximum output frequency of motor) multiply 10-16 (PID trim scale), the value can be used to modify the PID multiple.

11-Auxiliary Parameters

11-00	Direction Lock Selection
Range	0: Allow forward and reverse rotation 1: Only allow forward rotation 2: Only allow reverse rotation

If motor operation direction is set to 1 or 2, the motor can only operate in that specific direction. Run commands in the opposite direction are not accepted.

Forward or reverse commands can be issued via the control terminals or keypad.

Note: The Direction Lock Selection can be used in fan and pump application where reverse rotation is prohibited.

11-01	Carrier frequency
Range	【0】 : Carrier Output Frequency Tuning 【1~16】 : 1~16KHz

Notes:

- (1) Value 1 to 16 represents KHz.
- (2) When 11-01=0, variable carrier frequency is used see parameter 11-30~11-32.
- (3) For SLV mode, due to the sample rate, suggest using 4 KHz or 4 KHz above, and the motor cable used within 100m.
- (4) Setting range is determined by the inverter rating (13-00).
- (5) Refer to section 3 inverter derating based on carrier frequency.
- (6) A low carrier frequency increases motor noise but reduces motor losses and temperature.
- (7) A low carrier frequency decreases RFI, EMI interference and motor leakage current.

Refer to the carrier frequency Table 4.4.35.

Table 4.4.35 Carrier frequency settings

Carrier Frequency	1KHz--6KH—10KHz—16KHz	
Motor noise	High -----	Low
Output current waveform (similar to sinusoidal wave)	Bad -----	Good
Noise interference	Low -----	High
Leakage current	Low -----	High
Heat loss	Low -----	High

If cable length between the inverter and the motor is too long, the high-frequency leakage current will cause an increase in inverter output current, which might affect peripheral devices. Adjust the carrier frequency to avoid this as shown in table 4.4.36.

Table 4.4.36 Cable length and carrier frequency

Wire length	< 30 Meter (98ft)	up to 50 Meter (164 ft)	up to 100 Meter (328ft)	>= 100 Meter* >= 328ft
Carrier frequency (11-01 value)	Max. value 16KHz (11-01=16KHz)	Max. value 10KHz (11-01=10KHz)	Maxi. value 5KHz (11-01=5KHz)	Max. value 2KHz (11-01=2KHz)

***. If Cable is longer than 100m, the output dv/dt filter or output reactor is required.**

Notes:

- (1) Reduce the carrier frequency if the torque does not match the speed.
- (2) In V/F mode, set 11-01 to 0, the carrier frequency is determined by parameters 11-30 (Carrier frequency max. limit), 11-31 (Carrier frequency lower limit) and 11-32 (Carrier frequency proportional gain).

11-02	Soft PWM Function Selection
Range	【0】 : Disable 【1】 : Soft PWM 1 enables 【2】 : Soft PWM 2 enables

11-02=0: Soft PWM control disables.

11-02=1: Soft PWM 1 control enables. Soft PWM control can improve the 'metal' noise produced by the motor, more comfortable for the human ear. At the same time, Soft PWM also limits RFI noise to a minimum level. The default setting of Soft PWM control is disabled. Soft PWM 1 cannot be set if carrier frequency set in 11-01 is higher than 8 kHz.

11-02=2: Soft PWM 2 control enables. User adjusts parameter 11-66 (2 Phase/3 Phase PWM Switch Frequency), 11-67 (Soft PWM 2 Frequency Range) and 11-68 (Soft PWM 2 Switch Frequency) by his/ her own feeling to noise.

11-66	2 Phase/ 3 Phase PWM Switch Frequency
Range	【6.00~60.00】 Hz

When the output frequency is higher than 11-66, the PWM mode will be switched.

11-67	Soft PWM 2 Frequency Range
Range	【0~12000】
11-68	Soft PWM 2 Switch Frequency
Range	【6.00~60.00】

When the output frequency is higher than 11-68, the noise detect function will be enabled, and according to 11-67 to modify the magnetic noise of motor.

Note: When 11-02=2, sum of 11-01 and 11-67 should be lower than the upper limit of carrier frequency. To avoid the error setting, please follow the rules listed as below.

- If error occurs when setting 11-01, it means $11-02=2$ and $11-01 + 11-67 >$ Upper limit of carrier frequency, please reset 11-02 or 11-67.
- If error occurs when setting 11-67, it means $11-02=2$ and $11-01 + 11-67 >$ Upper limit of carrier frequency, please reset 11-02 or 11-01.
- When $11-02=2$, if error occurs when setting 11-01 or 11-67, it means $11-01 + 11-67 >$ Upper limit of carrier frequency, please reset the parameter.
- If error occurs when setting $11-02=2$, it means $11-01 + 11-67 >$ Upper limit of carrier frequency, please reset the parameter 11-01 or 11-67, then set $11-02=2$.

11-03	Automatic carrier lowering selection
Range	0: Disable 1: Enable

If inverter detects the overheating, the carrier frequency will decrease automatically. Once this temperature returns to normal, the carrier frequency will automatically return to the set value of 11-01.

11-03=0: Automatic carrier frequency reduction during an overheat condition is disabled.
Carrier frequency operation depends on the set value of 11-01.

11-03=1: Automatic carrier frequency reduction during an overheat condition is enabled.
Carrier frequency automatically decreases to reduce the heat loss and avoid the inverter's trip so as to extend the period of use in inverter when the heat sink temperature is higher than the sett value.

11-04	S curve time setting at the start of acceleration
11-05	S curve time setting at the end of acceleration
11-06	S curve time setting at the start of deceleration
11-07	S curve time setting at the end of deceleration
Range	0.00~2.50 Sec

The S curve function for acceleration / deceleration is used to reduce mechanical impact caused by the load during momentary starting and stopping of the inverter. To use the S curve function set the time for acceleration start point (11-04), acceleration end point (11-05), deceleration start point (11-06) and deceleration end point (11-07). Refer to figure 4.4.86 for more information.

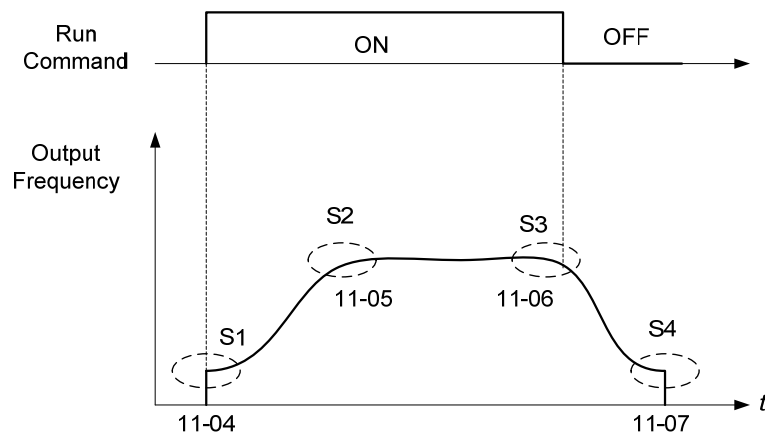

Figure 4.4.86 S curve characteristic

Total acceleration and deceleration time when the S curve is used:

$$\text{Accelerating time} = \text{Accelerating time 1 (or 2)} + \frac{(11-04) + (11-05)}{2}$$

$$\text{Deceleration time} = \text{Deceleration time 1 (or 2)} + \frac{(11-06) + (11-07)}{2}$$

11-08	Jump frequency 1
11-09	Jump frequency 2
11-10	Jump frequency 3
Range	0.0~599.0 Hz

11-11	Jump frequency width
Range	0.0~25.5 Hz

These parameters allow “jumping over” of certain frequencies that can cause unstable operation due to resonance within certain applications.

Note: Prohibit any operation within the jump frequency range. During acceleration and deceleration the frequency is continuous without skipping the jump frequency.

To enable jump frequency 1 – 3 (11-08 – 11-10) set the frequency to a value greater than 0.0 Hz.

Use the jump frequency width (11-11) to create a jump frequency range. Refer to figure 4.4.87.

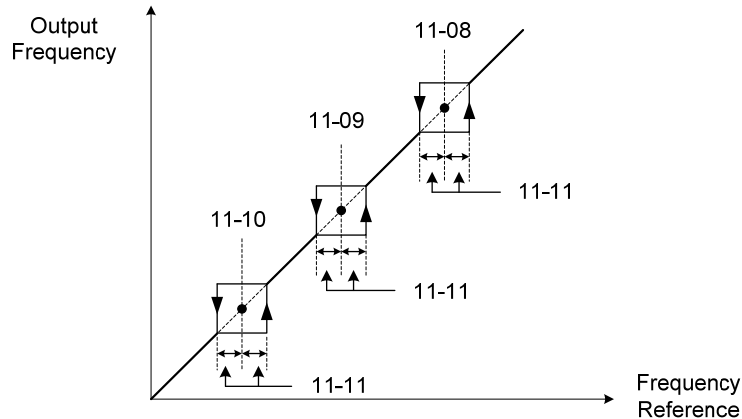

Figure 4.4.87 Jump frequency operation

Jump frequency via Analog Input.

Set parameter 04-05 (AI2 function selection) to 9 (frequency jump setting 4) to control the jump frequency via analog input AI2. Refer to Figure 4.4.48.

Note: When jump frequency overlap the sum of the overlapped jump frequencies will be used as the jump frequency range. Refer to figure 4.4.88.

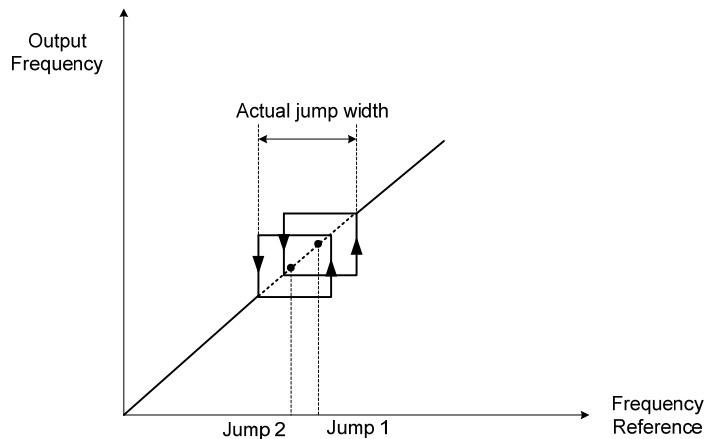

Figure 4.4.88 Jump frequency overlap

11-13	Automatic return time
Range	0~120 sec

If the keypad is not pressed within the time specified in 16-06 (returning time of automatic back button), the keypad will automatically return to the mode screen.

When it is set to 0, the automatic return function is off. Press the back button to return to the previous directory.

11-12	Manual energy saving gain
Range	0~100 %

11-18	Manual energy saving frequency
Range	0.0~599.0 Hz

Manual energy savings reduces the output voltage for the purpose of saving energy.

To enable manual energy savings set one of the multi-function digital input (03-00 to 03-05) to 20 and activate the input or use parameter 11-18 to set the manual energy savings activation frequency.

When the output frequency rises above the value set in parameter 11-18 manual energy savings function is enabled. Setting parameter 11-18 manual energy savings frequency to 0.0 Hz disables the manual energy savings frequency activation function. Refer to figure 4.4.88 for more information.

Note: Only use manual energy savings functions in combination with light loads.

Manual energy saving gain (11-12) determines the output voltage of the inverter when manual energy savings is enabled. Output voltage is percentage gain times the V/F voltage.

Manual energy saving control uses the voltage recovery time (07-23) to change the output voltage

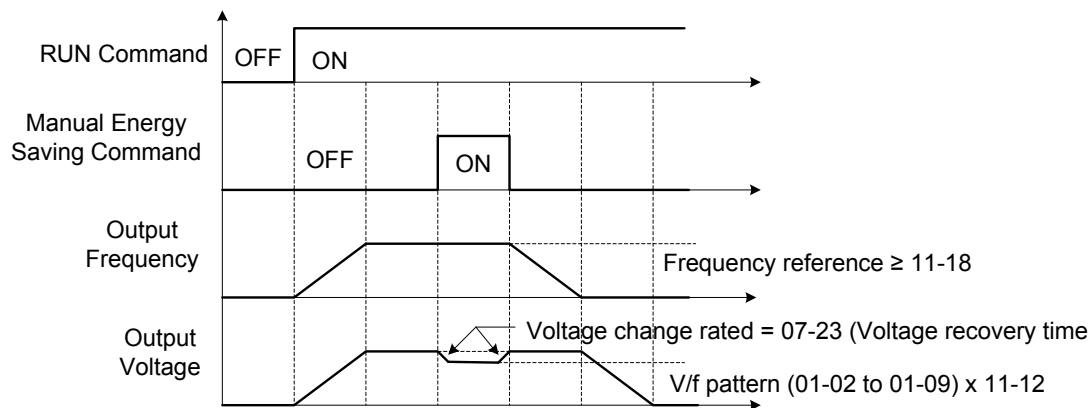

Figure 4.4.89 Manual energy saving operation

11-19	Automatic energy saving function
Range	0: Automatic energy saving is disabled 1: Automatic energy saving is enabled
11-20	Filter time of automatic energy saving
Range	0~200 msec
11-21	Voltage upper limit of energy saving tuning
Range	0~100%
11-22	Adjustment time of automatic energy saving
Range	0~5000 msec
11-23	Detection level of automatic energy saving
Range	0~100%
11-24	Coefficient of automatic energy saving
Range	0.00~655.35

In the V/F control mode the automatic energy saving (AES) function automatically adjusts the output voltage and reduces the output current of the inverter to optimize energy savings based on the load.

The output power changes proportional to the motor load. Energy savings is minimal when the load exceeds 70% of the output power and savings become greater when the load decreases.

The parameter of automatic energy saving function has been set at the factory before shipment. In general, it is no need to adjust. If the motor characteristic has significant difference from the TECO standard, please refer to the following commands for adjusting parameters:

Enable Automatic Energy Savings Function

- (1) To enable automatic energy saving function set 11-19 to 1.
- (2) Filter time of automatic energy saving (11-20)
- (3) Commissioning parameter of energy saving (11-21 to 11-22)

In AES mode, the optimum voltage value is calculated based on the load power requirement but is also affected by motor temperature and motor characteristic.

In certain applications the optimum AES voltage needs to be adjusted in order to achieve optimum energy savings. Use the following AES parameters for manual adjustment:

11-21: Voltage limit value of AES commissioning operation

Set the voltage upper limit during automatic energy saving. 100% corresponds to 380V or 440V depending on the inverter class used. Refer to the figure 4.4.90.

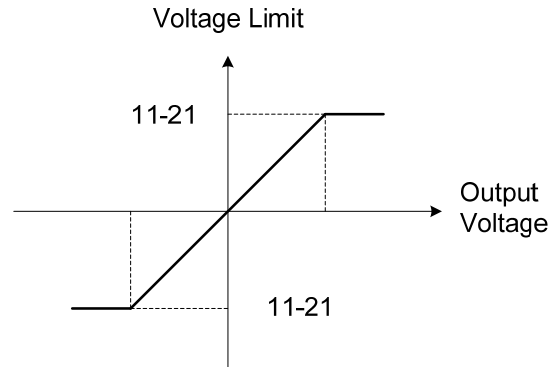

Figure 4.4.90 Voltage limit value of commissioning operation

11-22: Adjustment time of automatic energy saving

Sets sample time constant for measuring output power.

Reduce the value of 11-22 to increase response when the load changes.

Note: If the value of 11-22 is too low and the load is reduced the motor may become unstable.

11-23: Detection level of automatic energy saving

Set the automatic energy saving output power detection level.

11-24: Coefficient of automatic energy saving

The coefficient is used to tune the automatic energy saving. Adjust the coefficient while running the inverter on light load while monitoring the output power. A lower setting means lower output voltage.

Notes:

- If the coefficient is set to low the motor may stall.
- Coefficient default value is based on the inverter rating. Set parameter 13-00. If the motor power does not match the inverter rating.

11-29	Auto De-rating Selection
Range	0: Disable 1: Enable

The automatic de-rating function automatically reduces the output frequency by 30% of the nominal motor speed when the inverter detects an overheat condition (heatsink).

Automatic de-rating function depends on the automatic carrier frequency reduction selection (11-03).

If automatic carrier frequency reduction is disabled (11-03=0), the output frequency is reduced by 30% of the nominal motor speed when an overheat condition is detected.

If automatic carrier frequency reduction is enabled (11-03=1), the output frequency is reduced by 30% of the nominal motor speed when the carrier frequency is at its minimum setting.

11-29=0: Auto de-rating selection disabled, carrier frequency is based on 11-01 or 11-03.

11-29=1: Auto de-rating selection is enabled.

11-30	Variable Carrier Frequency Max. Limit
Range	2~16 KHz

11-31	Variable Carrier Frequency Min. Limit
Range	1~16 KHz

11-32	Variable Carrier Frequency Proportional Gain
Range	00~99

Carrier frequency method depends on the selected control mode.

Control Mode	Variable Carrier Frequency (11-01 = 0)	Fixed Carrier Frequency (11-01 = 2-16 kHz)
V/F	Available	Available
SLV	Not available	Available

Variable carrier frequency can be adjust with parameter 11-30 ~ 11-32.

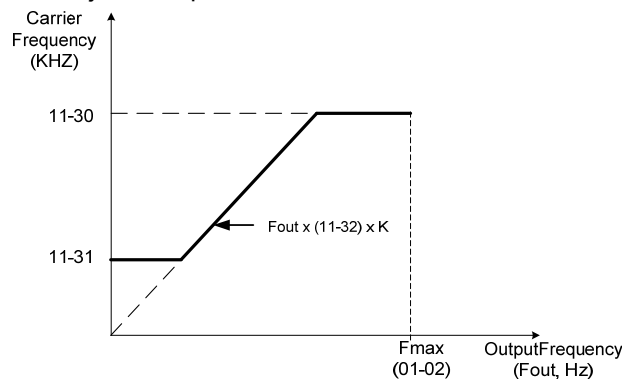

K is a coefficient; the value of K is based on the following based on the maximum carrier frequency:

K=1: when $11-30 < 5 \text{ KHz}$

K=2: when $10 \text{ KHz} > 11-30 \geq 5 \text{ KHz}$

K=3: when $11-30 \geq 10 \text{ KHz}$

Notes:

- In V/F control mode if the speed and torque are constant, the variable carrier frequency mode (11-01=0) can be selected to reduce the carrier frequency based on output frequency.
- If the carrier frequency proportional gain (11-32) > 6 and $11-30 < 11-31$, error message "SE01" out of range will appear on the keypad.
- If the minimum limit (11-31) is set higher than the maximum limit (11-30), the minimum limit will be ignored and the carrier frequency will be set at the highest limit (11-30).
- In fixed carrier frequency mode (11-01 = 2-16) parameters 11-30, 11-31 and 11-32 are not used.
- In SLV control mode, the maximum limit of the carrier frequency is fixed at 11-30.

11-28	Frequency Gain of Over Voltage Prevention 2
Range	1~200%

11-33	DC Voltage Filter Rise Amount
Range	0.1~1.00 V

11-34	DC Voltage Filter Fall Amount
Range	0.1~1.00 V
11-35	DC Voltage Filter Deadband Level
Range	0.0~99.0 V
11-36	Frequency gain of OV prevention
Range	0.000~1.000
11-37	Frequency limit of OV prevention
Range	0.00~599.00 Hz
11-38	Deceleration start voltage of OV prevention
Range	380V: 400~800 V
11-39	Deceleration end voltage of OV prevention
Range	380V: 600~800 V
11-40	OV prevention selection
Range	0: Disable 1: OV prevention Mode 1 2: OV prevention Mode 2 3: OV Prevention Mode 3

Overvoltage suppression is used for the application of likely causing to energy recharge.

Example: there are two situations causing excessive energy to recharge the inverter in stamping application

- (1) When cam clutch is not engaged, the motor will accelerate and start flywheel. When motor decelerates, the rotation speed will higher than motor speed owing to the large flywheel's inertia and then recharge the inverter.
- (2) When cam clutch is engaged, the motor will start flywheel and compress the spring. When the highest point of the cam moves beyond its center, the spring will release the power to the flywheel and excessive energy output recharge the inverter.

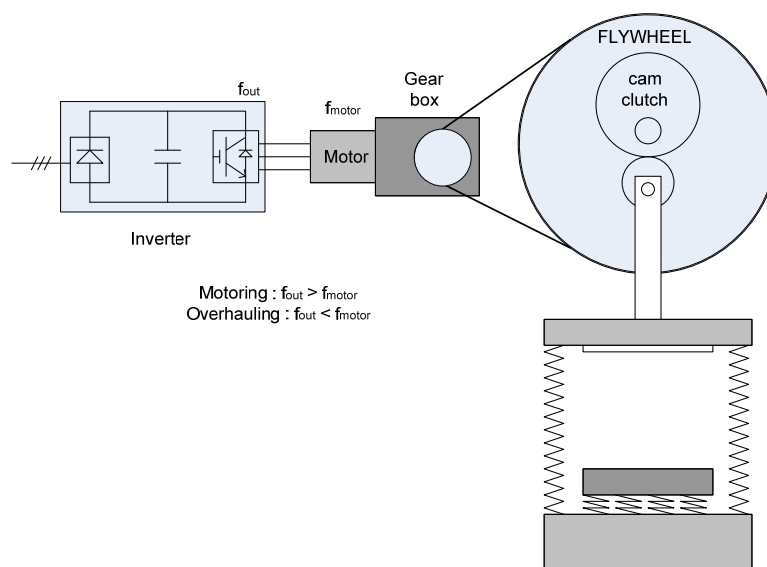

Figure 4.4.91 Stamping Operation

Over-voltage prevention (OVP) function monitors the DC-bus voltage and adjusts the speed reference, acceleration and deceleration rate, to prevent the inverter from tripping on an overvoltage.

When the speed reference is reduced, the motor will start to decelerate. When the inverter is operating at a fixed output frequency and excessive regenerative energy back to the inverter is detected the inverter will accelerate the motor in order to reduce the DC-bus voltage. Refer to figure 4.4.92.

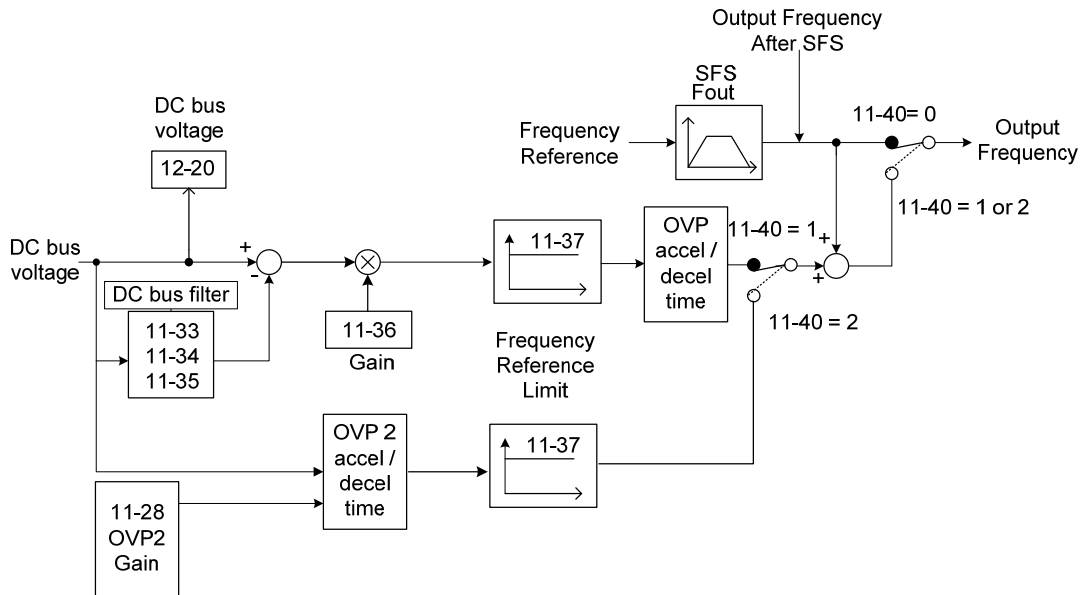

Figure 4.4.92 OVP operation

When 11-40=1: OV prevention Mode 1

1) DC voltage filter is used to provide a stable reference value for determining the change in DC voltage change during regenerative operation.

- Adjust the DC voltage filtering increase rate parameter 11-33 (DC Voltage Filter Rise Amount). When the DC voltage exceeds 11-33 +11-35 (DC Voltage Filter Deadband Level), the output of the filter will increase.
- Adjust the DC voltage filtering decrease rate parameter 11-34 (DC Voltage Filter Fall Amount). When the DC voltage exceeds 11-33 +11-35 (DC Voltage Filter Deadband Level), the output of the filter will decrease.
- Monitor the DC voltage filter output by 12-20 (DC voltage filter value).
- Set the DC voltage filter decrease rate (11-34) to a greater value than the value of the DC voltage filtering increase rate (11-33).

2) When the inverter is operation at a fixed output frequency, the OVP function will monitor the DC-bus voltage to detect regenerative operation.

In case of a regenerative condition the inverter calculates the delta DC bus voltage value and multiplies the value with parameter 11-36, the result is added to the frequency reference accelerating the motor to prevent on an overvoltage condition.

When the regenerative energy decreases, the inverter output frequency will return to the actual frequency reference. Deceleration rate is based on the DC voltage, as shown in Figure 4.4.93.

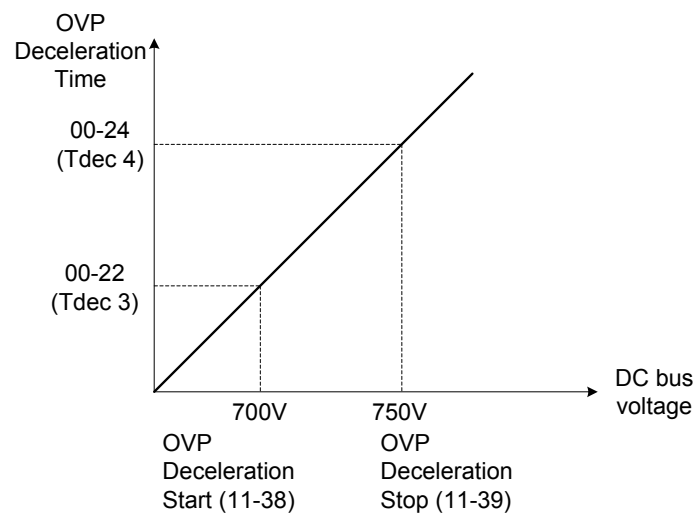

Figure 4.4.93 OVP deceleration time

3) When the inverter is stopped, the deceleration rate can be set with parameter 00-15 (Tdec1). In case the DC voltage is too high, the inverter will decelerate based on the OVP deceleration time as shown in Figure 4.4.92.

- Set DC-bus voltage in parameter 11-38 (start voltage of OVP deceleration) and set OVP deceleration rate in 00-22 (Tdec3).
- When the DC voltage reaches this level, it is necessary to decelerate rapidly in order to prevent the delta DC voltage of becoming too large.

- When DC voltage reaches the setting of 11-39 (stop voltage of OVP deceleration), it will decelerate based on the set value of 00-24 (Tdec4)
 - Deceleration rate is linear based on the slope defined by the start point (11-38) and end point (11-39).
- 4). Enable the OVP function with parameter 11-40 set to 1 or 2. The following parameter default values will be changed when the OVP function is enabled:

00-14(Tacc1)= 5.0 Sec(the frequency reference acceleration rate when DC voltage is too high.)
 00-22(Tdec3)= 20.0 Sec(low setting point of OVP deceleration rate).
 00-24(Tdec4)= 100.0 Sec(high setting point of OVP deceleration rate).

Note: S curve should be disabled when using the OVP function (11-04~11-07=0.0sec).

When 11-40=2: OV prevention Mode 2

The process of OV prevention mode 2 is the same as that of OV prevention mode 1 but it strengthens more the part of DC BUS over the deceleration stop voltage of OV prevention (11-39) in Fig.4.4.92. It can accelerate frequency compensation to avoid OV protection by increasing frequency gain of OV prevention 2 (11-28).

When 11-40=3: OV prevention Mode 3

T=The inverter raise the output frequency temporarily to avoid OV, the output frequency wont higher than the value of 01-02 (Maximum Output Frequency of Motor 1).Please adjust the value of 01-02 according to application. If it still occur OV in 11-40=3, please raise the value of 11-64 in 0.1 unit.

11- 64	Acceleration Speed Gain Adjustment
Range	0.1~10.0

It will influence the speed and current if the value of 11-64 is too high.

11- 65	Target Main Circuit Voltage
Range	380V: 400V~800V

11- 41	Reference frequency loss detection
Range	0: when reference frequency disappears, the deceleration will stop. 1: when reference frequency disappears, continue to operate according to the proportion of reference frequency x 11-42.

11- 42	Reference frequency loss level
Range	0.0~100.0 %

A Reference frequency loss is detected when the frequency command falls 90% within 360ms.

The action performed when a reference loss is detected is set with parameter 11-41.

11-41=0: Inverter will decelerate to a stop when a reference loss is detected.

11-41=1: Inverter will continue to operate; reference frequency is the value of Maximum Output Frequency of Motor 1 x the level set in parameter 11-42.

The inverter will return to normal operation when:

- (1) The reference frequency is restored while running and the reference level exceeds 80% of the master

frequency command.

(2) Stop command is issued.

Notes:

- Reference frequency loss level (11-42) is corresponding to the maximum output frequency of Motor 1 (01-02).
- Reference frequency loss level is used in the analog signal (1: AI1 or 7: AI2) from the selection of main frequency source (00-05).

Refer to the following Fig. 4.4.94 for the operation diagram of multi-function digital output (03-11~03-12) when the analog frequency command is in the loss of frequency command.

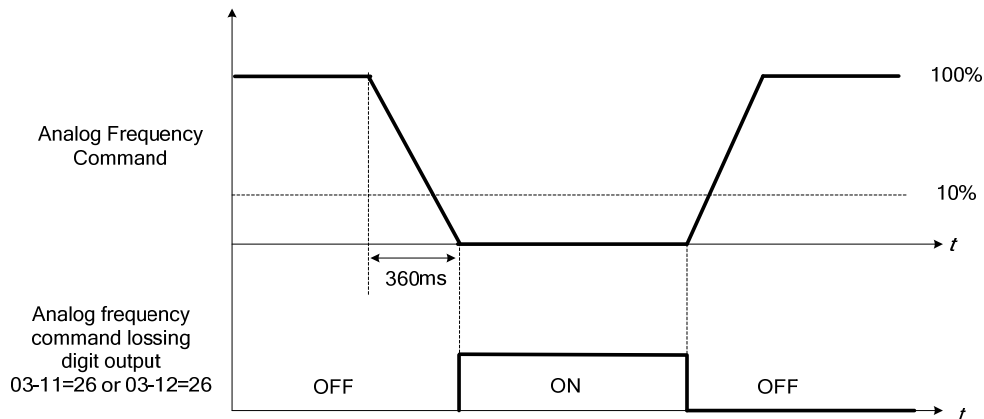

Figure 4.4.94 Operation in reference frequency loss

11-43	Hold frequency at start
Range	0.0~599.0 Hz
11-44	Frequency hold time at start
Range	0.0~10.0 Sec
11-45	Hold frequency at stop
Range	0.0~599.0 Hz
11-46	Frequency hold time at stop
Range	0.0~10.0 Sec

The hold function is used to temporarily hold the reference frequency in order to prevent stalling the motor or preventing an over current condition during starting or stopping due to load conditions.

During start the inverter will operate at the hold frequency at start for the time specified in the parameter 11-44 in order to establish the magnetic flux.

Note: The acceleration of deceleration time does not include the start and stop hold time. Refer to the figure 4.4.95.

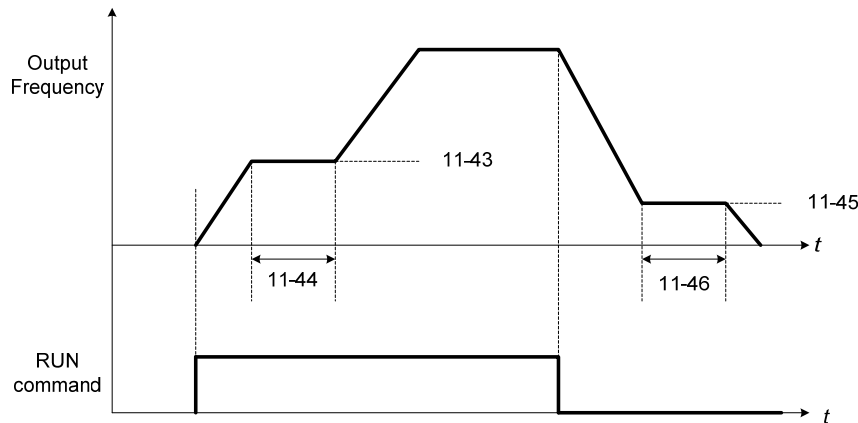

Figure 4.4.95 Reserved function

When the inverter is in stop mode, this function can also be used to prevent wind milling. In addition, it can be used for the purpose of braking using the motor to consume the braking energy resulting in a better controlled stop. Refer to the DC brake parameter 07-16 for DC braking during start.

Notes:

- The hold function at start is inactive when the hold frequency at start (11-43) is set to a value less than Fmin (01-08).
- The hold function at stop is inactive when the hold frequency at stop (11-45) is set to a value less than Fmin (01-08).

11- 47	KEB Deceleration time
Range	0.0~25.5 Sec
11- 48	KEB detection level
Range	380V: 380~420 V

KEB function can be used to keep the inverter from tripping on a under voltage condition due to a momentary power-loss. To enable the KEB function set parameter 11-47 to a value greater than 0.0 sec.

Upon detection of a power-loss the inverter uses the KEB deceleration time (11-47) to decelerate the motor and using the regenerative energy from the motor to maintain the DC-bus at a nominal level.

11-48: KEB detection level

If the DC-bus voltage falls below the value set in 11-48, the KEB is activated and the inverter starts decelerating according to the value set in 11-47.

To accelerate back to the original output frequency one of the digital inputs (03-00 to 03-05) set for 48 (KEB acceleration) has to be activated and the DC voltage has to rise above 11-48 + delta V (Delta V = +20 V for 380V Series).

Refer to the example in Figure 4.4.96.

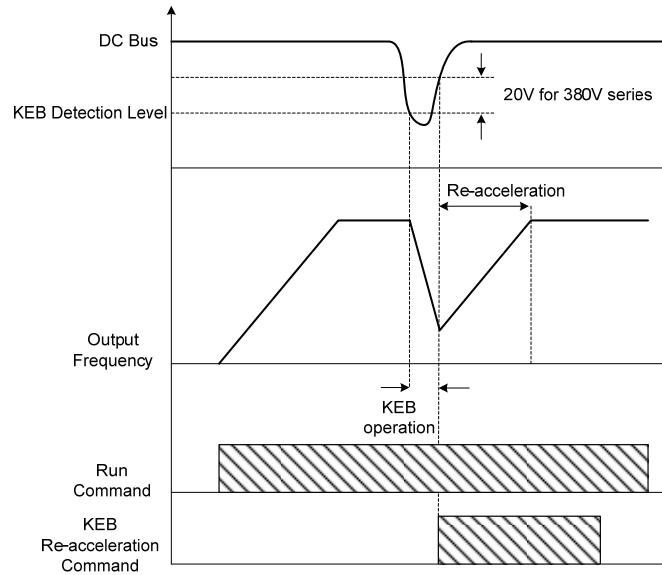

Figure 4.4.96 KEB operation

11- 51	Braking selection of zero-speed
Range	0: Zero-speed DC braking is disabled 1: Zero-speed DC braking is enabled

11-51: Operation selection of zero-speed braking

In V/F control mode, the DC braking operation can be used to the motor shaft.
Set 11-51 to select zero-speed braking operation to 1 to enable this function.

To use DC braking operation set parameter 00-02 (operation command selection) to 1 and parameter 00-05 (frequency reference selection) to 1, the operation command and frequency reference are now set for external control. When the frequency reference is 0V (or less than 4mA), and the operation command is turned on, the zero-speed 'DC' braking operation is activated and holding torque is generated using DC braking.

Refer to Figure 4.3.98 for more information on zero-speed DC braking operation.

Note: DC braking 07-07 is limited to 20% of the inverter rated current.

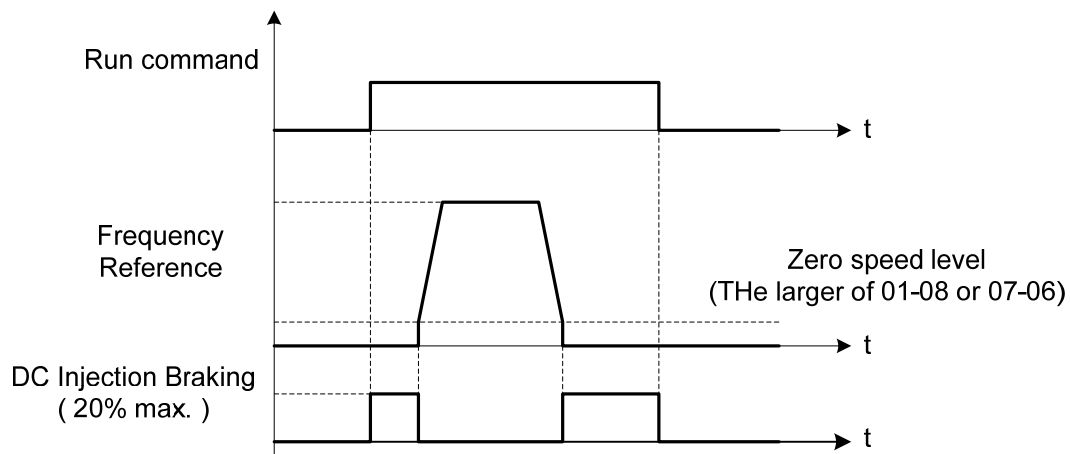

Figure 4.4.98 Zero-speed braking operation

11-54	Output KWHr initialization
Range	0: Do not clear output KWHr 1: Clear output KWHr

Reset kW-hour meter (12-40).

11-55	STOP key selection
Range	0: Stop key is disabled when the operation command is not provided by operator. 1: Stop key is enabled when the operation command is not provided by operator.

11-55= 0: Stop button disabled when operation command is set for terminals (00-02=1) or communication (00-02=3).

11-55= 1: Stop button enabled

11-56	UP/DOWN selection
Range	0: UP/DOWN reference frequency adjustment with ENTER key. 1: UP/DOWN reference frequency adjustment without ENTER key.

11-56= 0: Changing the reference frequency on the keypad in UP/DOWN control requires the ENTER button to be pressed for the inverter to accept the modified reference frequency.

11-56= 1: Changing the reference frequency on the keypad in UP/DOWN control immediately changes the reference frequency and there for the output frequency.

Note: The reference frequency can be changed (up or down) via the keypad or by setting one of multi-functional digital input terminals (03-00, 03-05) to 8 and 9. Refer to instructions of (03-00 - 03-05 = 8 or 9).

11- 58	Record reference frequency
Range	0: Disable 1: Enable

This function is enabled only when one of multi-function digital input terminals (03-00 to 03-05) is set to 11 (Inhibit ACC / DEC command).

11-58= 0: When ACC / DEC inhibition command is enabled, the motor will stop accelerate or decelerate, and the frequency at the moment will be used as frequency command. If ACC / DEC inhibition command is disabled or stop command enabled, the frequency command will set to original frequency.

Besides, when stop command enabled, or the power is cut off and reset. The frequency will be set to 0 Hz

Note: If ACC / DEC inhibition command is enabled before running, it will display STP0 after running, due to there is no reference frequency record.

11-58= 1: When ACC / DEC inhibition command is enabled, the output frequency will be recorded and to be used as frequency command. When it switches to stop or the power is cut off and reset, the ACC / DEC inhibition command is still enabled, the frequency command is still recorded and the frequency command is set to the frequency that was recorded.

Please refer to the following figure.

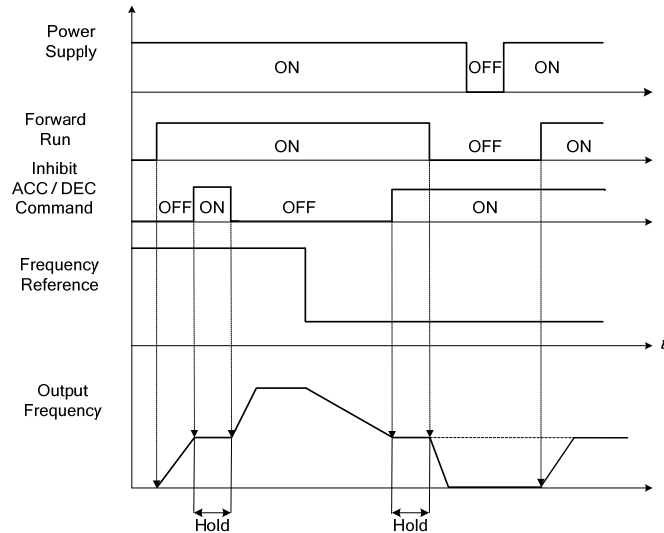

11- 59	Gain of Preventing Oscillation
Range	0.00~2.50

It is used to adjust preventing oscillation function.

If the oscillation in driving motor occurs at normal duty, it is required to increase the setting value gradually in the unit of 0.01.

11- 60	Upper Limit of Preventing Oscillation
Range	0~100 %

It is required to limit the preventing oscillation upper limit within the setting value.

11- 61	Time Parameter of Preventing Oscillation
Range	0~100

Adjust the response of oscillation function. (Time parameter of adjust preventing oscillation function delay.)

11- 62	Selection of Preventing Oscillation
Range	0: Mode 1 1: Mode 2 2: Mode 3

When 11-62=0 and 1: Mode 1 and 2, the response to preventing oscillation is slower.

When 11-62=2: Mode 3, the response to preventing oscillation is faster.

11- 63	Strong Magnetic Selection
Range	0: Disable 1: Enable

11-63=0: It has no function of flux-strengthening, the no-load current of high speed and low speed are the same.

11-63=1: It has function of flux-strengthening, the torque of low speed is higher, but the no-load current is also higher, it is suitable for big load in low speed.

11- 69	Gain of Preventing Oscillation 3
Range	0.00~200.00 %

Adjust the response of Gain of Preventing Oscillation 3
 If occur vibration with motor in ND mode, please increase by 0.01 unit to set.

11- 70	Upper Limit of Preventing Oscillation 3
Range	0.01~100.00 %

It is required to limit the preventing oscillation 3 upper limit within the setting value.

11- 71	Time Parameter of Preventing Oscillation 3
Range	0~30000 ms

Adjust the response of oscillation 3 function. (Time parameter of adjust preventing oscillation function delay.)

11- 72	Gain of Preventing Oscillation for switch frequency 1
Range	0.01~300.00 Hz

11- 73	Gain of Preventing Oscillation for switch frequency 2
Range	0.01~300.00 Hz

Refer to the following for the setting of 11-72 and 11-73.

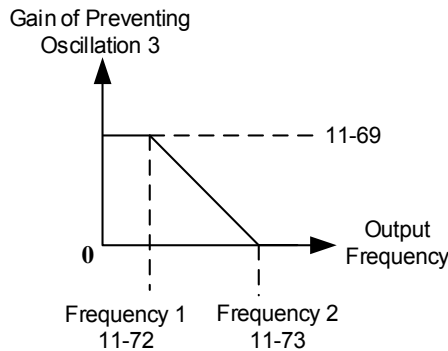

12-Monitoring Parameters

12-00	Display screen selection (LED)
Range	<p>Highest bit => 0 0 0 0 0 <= lowest bit The value range of each bit is 0~7 from the highest bit to the lowest bit, 0: No display 1: Output current 2: Output voltage 3: DC bus voltage 4: Heatsink temperature 5: PID feedback 6: AI1 value 7: AI2 value</p>

Note: The highest bit is used for power-up monitor. The 4 least significant bits can be used to customize the display sequence see chapter 4.1.3.

12-01	PID feedback display mode (LED)
Range	<p>0: Display the feedback value in integer (xxx) 1: Display the feedback value with one place after the decimal point (xx.x) 2: Display the feedback value (x.xx) with two places after the decimal point</p>

12-02	PID feedback display unit setting (LED)
Range	0: xxxxx (no unit) 1: xxxPb (pressure) 2: xxxFL (flow)

When 12-00=xxx5, LED preset screen will display PID feedback. Parameter 12-01 will refer to the value of 10-33 and display five-digit XXX.XX.

For example,

When 10-33=9999, preset screen of 12-01=0 will display 99, 12-01=1 will display 99.9, and 12-01=2 will display 99.99.

If setting of 12-02 is also referred, 12-01=1 and 12-02=1 will display five-digit 99.9Pb; 12-01=2 and 12-02=2 will display 9.99FL and decimal 9 will be hidden.

12-03	Line Speed Display (LED)
Range	【0~60000】 RPM
12-04	Line Speed Display Mode (LED)
Range	【0】 : Display Inverter Output Frequency 【1】 : Line Speed Display at Integer.(xxxxx) 【2】 : Line Speed Display at One Decimal Place. (xxxx.x) 【3】 : Line Speed Display at Two Decimal Places. (xxx.xx) 【4】 : Line Speed Display at Three Decimal Places. (xx.xxx)

12-04=0

Inverter displays the line speed at stop, operation or the modification of frequency.

12-04≠0

12-03 is set to the maximum line speed and corresponds to the maximum output frequency.

For example, if the line speed display of 12-03 is 1800, the keypad display is 900 when frequency output is 30Hz.

12-05	Status display of digital input terminal (LED / LCD)
Range	Read-only

Terminals S1-S6 are represented using two segments of each digit. Segment turns on when input is active. The bottom segments of each of the first three digits are used to represent the digital outputs (R1, R2, DO1). Segments turn on when output is active.

Example1: S1~S6, R1, R2 and DO1 are ON

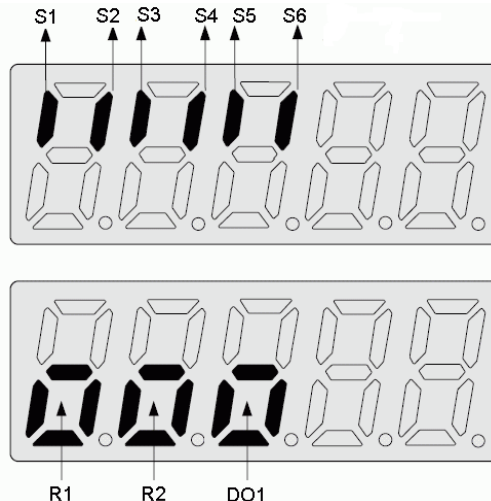

4-211

Note: Refer to section 4.3 for monitors 12-11~12-64.

Monitoring parameter 12-67: Cumulative Energy (KWHr) & **12-68:** Cumulative Energy (MWHr)

Initialization of Cumulative Energy of 11-54 can clear these monitoring parameters.

Monitoring parameter 12-38: PID setting & **12-39:** PID Feedback

Refer to the setting of 10-33~10-35.

Monitoring parameter 12-76: No-Load Voltage Output

It is required to be with the descriptions of parameter 02-09 (excitation current of motor 1) and parameter 17-09 (motor excitation current).

Monitoring parameter 12-79: Pulse Input Percentage

Refer to parameter 03-30 (Selection of pulse input)

Note: It can perform run command when viewing monitoring parameters (12-05~12-79).

13-Maintenance Parameters

13-00	Inverter Capacity Selection
Range	----

Inverter model:	13- 00 display	Inverter model:	13- 00 display
T310-4015-XXX	415	T310-4100-XXX	4100
T310-4020-XXX	420	T310-4125-XXX	4125
T310-4025-XXX	425	T310-4150-XXX	4150
T310-4030-XXX	430	T310-4175-XXX	4175
T310-4040-XXX	440	T310-4215-XXX	4215
T310-4050-XXX	450		
T310-4060-XXX	460		
T310-4075-XXX	475		

13-01	Software version
Range	----

13-02	Clear Cumulative Operation Hours
Range	0: Disable to Clear Cumulative Operation Hours 1: Clear Cumulative Operation Hours

13- 03	Cumulative operation hours 1
Range	0~23 hours

13- 04	Cumulative operation hours 2
Range	0~65535 days

When 13-02=1, time set of 13-03/ 13-04 will be deleted.

13-05	Selection of cumulative operation time
Range	0: Accumulative operation time while power on 1: Accumulative operation time when it is operating.

13-05= 0: Inverter logs the time while the inverter is powered-up.

13-05= 1: Inverter logs the time when the inverter is running.

13-06	Parameters lock
Range	0: Parameters are read-only except 13-06 and main frequency 1: User Defined Parameters 2: All parameters are writable

Note: Main frequency setting is 12-16. The value is equal to frequency setting of speed-stage 0 (05-01)

13- 07	Parameter Lock Key Code
Range	【00000~65535】

➤ When parameter lock key code is enabled (13- 07>0), all parameter except main frequency can't be modified. Only unlock the key code, modify the parameters is allowable.

➤ Setting parameter lock key number example:

Step 1

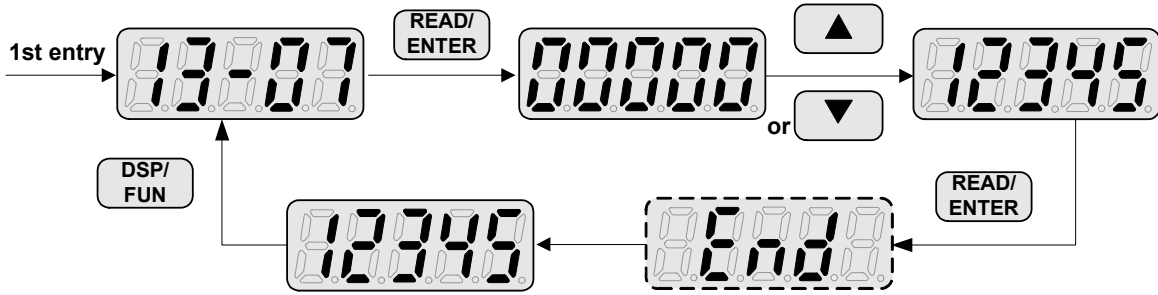

Step 2:

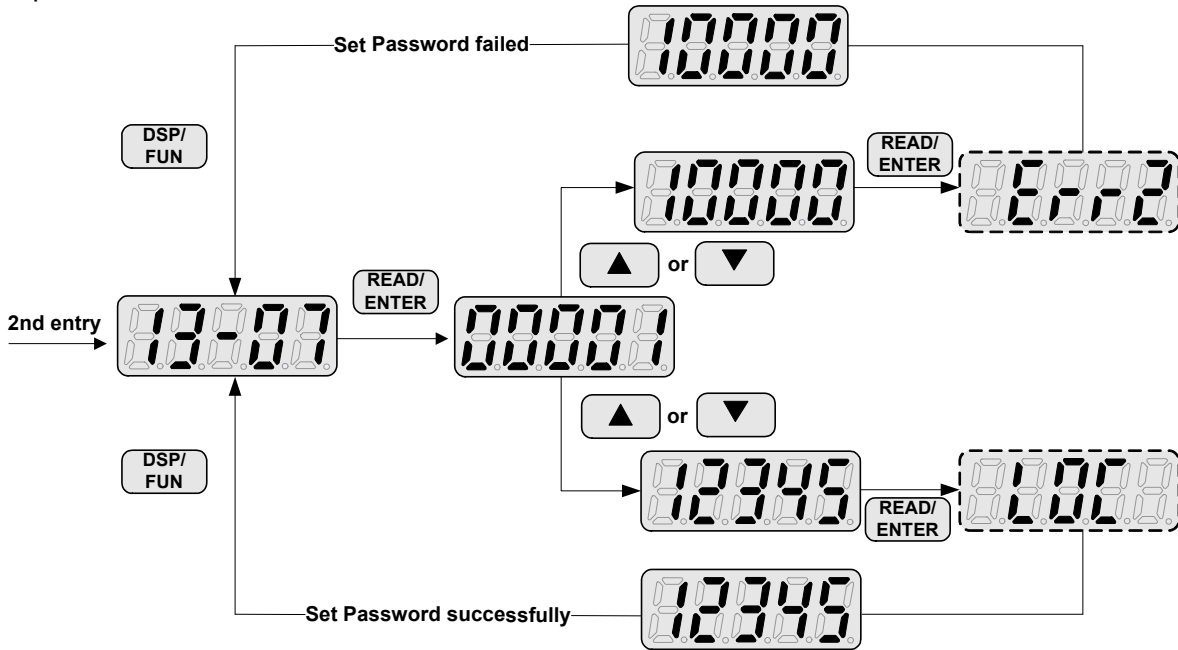

13-08=7: 3-wire initialization (50Hz) (380V)

Multi-function digital input terminal S6 controls the forward / reverse direction, and terminals S1 and S2 are set for 3-wire start operation and stop command. Inverter input voltage (01-14) is automatically set to 380V.

When 01-00V/Curve= F, 01-02 will automatically set to 50Hz.

Parameters don't be influenced by Restore factory setting / Initialize (13-08)

No.	Parameters
00-00	Control Mode Selection
01-00	V/F Curve Selection
01-26	V/F Curve Selection of Motor 2
13-00	Inverter Capacity Selection
13-03	Cumulative Operation Hours 1
13-04	Cumulative Operation Hours 2
13-05	Selection of Cumulative Operation Time

13-09	Fault history clearance function
Range	0: Do not clear fault history 1: Clear fault history

13-09=1: Clears inverter fault history.

Note: parameters 12-11~12-15/12-45~12-64 are cleared as well.

13-10	Parameter Password Function 2
Range	0 ~ 9999

13-11	C/B CPLD Ver.
Range	0.00~9.99

This parameter displays the CPLD software version on the control board. It is only displayed on the control board with CPLD.

13-14	Fault Storage Selections
Range	0: Fault Messages of Auto Restart are not saved. 1: Fault Messages of Auto Restart are saved.

13-14=0,

The fault messages are not saved in the fault history (12-46~12-49 & 13-21~13-50) in the process of restart when the auto reset function is active.

13-14=1,

The fault messages are saved in the fault history (12-46~12-49 & 13-21~13-50) in the process of restart when the auto reset function is active.

Note: Parameters 13-21~13-50 are 30 Fault History: When it detect fault, inverter will store to fault history. If the fault occurs again, parameter 13-21 will change to parameter 13-22.

17-Automatic Tuning Parameters

17-00	Mode selection of automatic tuning
Range	0: Rotational auto-tuning 1: Static auto-tuning 2: Stator resistance measurement 3: Reserved 4: Loop tuning 5: Rotational Auto-tuning Combination (Item: 4+2+0) 6: Static Auto-tuning Combination (Item: 4+2+1)
17-01	Motor rated output power
Range	0.00~600.00 kW
17-02	Motor rated current
Range	For VF mode, 10%~200% of the inverter rated current For SLV mode, 25%~200% of the inverter rated current.
17-03	Motor rated voltage
Range	380V: 100.0~480.0 V
17-04	Motor rated frequency
Range	4.8~599.0 Hz
17-05	Motor rated speed
Range	0~24000 rpm
17-06	Pole number of motor
Range	2~16 pole
17-08	Motor no-load voltage
Range	380V: 100~480 V
17-09	Motor excitation current
Range	15~70% motor rated current
17-10	Automatic tuning start
Range	0: Disable 1: Enable
17-11	Error history of automatic tuning
Range	0: No error 1: Motor data error 2: Stator resistance tuning error 3: Leakage induction tuning error 4: Rotor resistance tuning error 5: Mutual induction tuning error 6: Encoder error 7: DT Error 8: Motor's acceleration error 9: Warning

Auto-tuning

Based on the motor nameplate set the motor rated output power (17-01), motor output rated current (17-02), motor rated voltage (17-03), motor rated frequency (17-04), motor rated speed (17-05) and number of motor poles (17-06) to perform an auto-tune.

- Automatic tuning mode selection (17-00)

Rotational auto-tuning (17-00=0) provide higher quality for motors.

After executing Rotational auto-tuning (17-00), Excitation current of motor 1 (02-09), Core saturation coefficient 1 of motor 1(02-10), Core saturation coefficient 2 of motor 1 and Core saturation coefficient 3 of motor 1 (02-12) will renew the value.

Static auto-tuning (17-00=1) won't rotate the motor while auto-tuning.

After executing Static auto-tuning (17-00=1), Proportion of motor leakage inductance (02-33) and Motor slip (02-34) will renew the value.

Stator resistance measurement (17-00=2) provide for long motor leads (the inverter/motor leads are longer than 167ft (50m)).

After executing Stator resistance measurement (17-00=2), Resistance between wires of motor 1(02-15) will renew the value.

Loop tuning (17-00=4) provide great response of current circuit, it can improve frequency bandwidth of current and torque.

Rotation Auto-tuning Combination (17-00=5) is the auto-tuning for three in one, including Loop tuning (17-00=4), Stator resistance measurement (17-00=2) and Rotational auto-tuning (17-00=0).

Static Auto-tune Combination (17-00=6) is the auto-tuning for three in one, including Loop tuning (17-00=4), Stator resistance measurement (17-00=2) and Static auto-tuning (17-00=1)

- Motor rated output power (17-01)
The initial value is set by inverter capacity (13-00). Set by label of the motor.
- Motor rated current (17-02)
The initial value is set by inverter capacity (13-00). Set by label of the motor.
Set the range to 10 %~120 % of the inverter rated current.
If in SLV mode, set the range to 25 %~120 % of the inverter rated current.
- Motor rated voltage (17-03)
- Motor rated frequency (17-04) Set by label of the motor.
- Motor rated speed (17-05) Set by label of the motor.

When tuning a special motor (e.g. constant power motor, high-speed spindle motor), with a motor rated voltage or rated motor frequency that is lower than a standard AC motor, it is necessary to confirm the motor nameplate information or the motor test report.

Prevent the inverter output voltage from saturation when the motor rated voltage is higher than the inverter input voltage (see Example 1).

Example 1: Motor rated voltage (440V/60Hz) is higher than the inverter input voltage (380V/50 Hz).

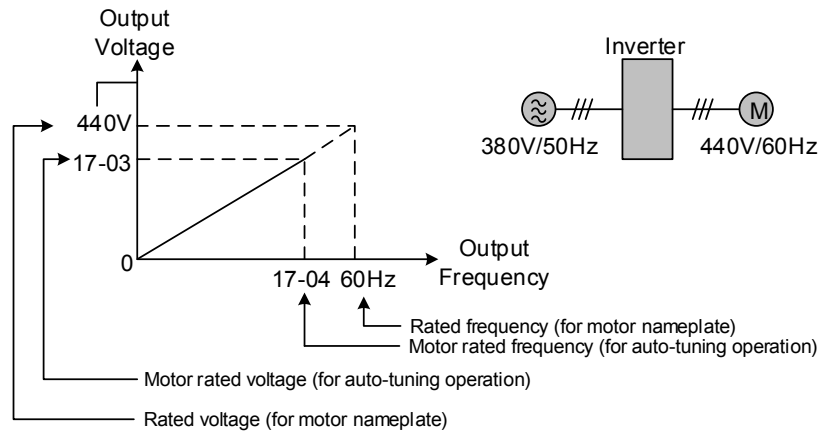

Figure 4.4.99 Rated voltage and frequency settings

- Step 1: Set auto-tuning (17-00), and set motor rated output power (17-01) and the motor rated current (17-02) by label of the motor.
- Step 2: Set the value of motor rated voltage (17-03) =440V by label of the motor.
- Step 3: Set the value of motor rated frequency (17-04) =60Hz
- Step 4: Set the value of motor rated speed (17-05) 、 pole number of motor (17-06)
- Step 5: Set the value of motor no-load voltage (17-08) =360V, the set value for torque control is 20V lower than input voltage.
- Step6: Execute auto-tuning. Set auto-tuning (17-10=1) and enter to standby screen. Enter RUN command to start auto-tuning. The value of motor rated frequency (17-04) adjusts automatically to the same as the value of base frequency of motor 1. If the value of maximum output frequency of motor 1 (01-02) is different from base frequency of motor 1 (01-12), the system will adjust the value of maximum output frequency of motor 1 (01-02) the same as base frequency of motor 1 (01-12) automatically.

When the inverter input voltage (or frequency) is higher than the motor rated voltage (or frequency), set the motor rated voltage (17-03) and the motor rated frequency (17-04) to the rated frequency on the motor nameplate.

Example 2: The inverter input voltage and frequency (460V/50Hz) are higher than the motor rated voltage and frequency (380V/33Hz), set 17-03 to 380V (rated motor voltage) and 17-04 to 33Hz (motor rated frequency).

- Number of poles (17-06)
Set the motor pole number with its range is 2, 4, 6 and 8 poles
- Motor no-load voltage (17-08)
 - a) Motor no-load voltage is mainly used SLV mode, set to value 10~50V lower than the input voltage to ensure good torque performance at the motor rated frequency.
 - b) Set to 85 ~ 95% of the motor rated voltage. In general, the no-load voltage can be closer to the motor rated voltage for larger motors, but cannot exceed the motor rated voltage.
 - c) The motor no-load voltage can be set to a value greater than the actual input voltage. In this case, the motor can only operate under relatively low frequency. If the motor operates at the rated frequency an over voltage condition may occur.
 - d) The higher the motor power is, the higher the no-load voltage is.
 - e) A smaller no-load voltage will reduce the no-load current.
 - f) When load is applied the magnetic flux is weakened and the motor current increases.
 - g) A higher no-load voltage results in a higher the no-load current.
 - h) When load is applied the magnetic flux weakens and the motor current increases. Increasing the magnetic flux generates back EMF and results in poor torque control.

- Motor excitation current (17-09)
 - a) Motor excitation current is used for rotational auto-tune.
 - b) Set motor excitation current to 33% of the motor rated current. Refer to parameter 02-09 for test running.
 - c) Only the static-type or stator resistance measurement auto-tune (17-00=1 or 1700=2) can be set.
 - d) It is required to refer to the monitoring parameter 12-76 for adjusting the motor excitation current (17-09).
When the excitation current change, parameter 12-76 is also affected so it should be adjusted to the setting no-load voltage (17-08).

- Automatic tuning start (17-10)
Set parameter 17-10 to 1 and press ENTER the inverter will display "Atrdy" for Auto-tune ready. Next press RUN to start the auto-tune procedure. During auto-tune the keypad will display "Atune" for Auto-tune in progress. When the motor is successfully tuned, the keypad shows "AtEnd".

- Error history of automatic tuning (17-11)
If auto-tuning fails the keypad will display the "AtErr" message and the auto-tune cause is shown in parameter 17-11. Refer to section 5 for troubleshooting and possible automatic tuning error causes.

Note: The motor tuning error history (17-11) shows the tuning result of the last auto-tune. No error is displayed when auto-tune is aborted or when the last auto-tune was successful.

Perform the "Stator resistance measurement" (17-00=2) auto-tune if the inverter/motor leads are longer than 167ft (50m).

For the best performance in vector control perform the rotary-type automatic tune (17-00 = 0) first (using short motor leads between the inverter and motor) and a "Stator resistance measurement" (17-00=2) next.

If a rotary auto-tune (17-00=0) cannot be performed, manually enter the mutual induction (02-18), excitation current (02-09), core saturation compensation factor 1-3 (02-11 - 02-13).

Perform the "Stator resistance measurement" (17-00=2) in V/F control when inverter/motor leads are longer than 167ft (50m).

17-12	Proportion of Motor Leakage Inductance
Range	0.1~15.0 %

Only the stator resistance auto tune (17-00=2) can be set.

The static non-rotational type and rotational type auto tune will automatically measure the proportion of motor leakage inductance so this parameter is not active.

It is set the value to 4%. Refer to parameter 02-33 for test run to adjust.

17-13	Motor Slip Frequency
Range	0.10~20.00 Hz

Only the stator resistance auto tune (17-00=2) can be set.

The static non-rotational type and rotational type auto tune will automatically measure the proportion of motor leakage inductance so this parameter is not active.

Refer to parameter 02-34 for counting the setting value.

17-14	Rotational Auto-tuning
Range	【0】 : VF type rotational auto-tuning 【1】 : Vector type rotational auto-tuning

It can be set (17-14) only if Rotational auto-tuning (17-00=0) or Rotational Auto-tuning Combination (17-00=5). VF type rotational auto-tuning (17-14=0) applies the standard IM motor that won't shake without loading for V/F mode. This function is highly applicable,

Vector type rotational auto-tuning (17-14=1) applies the special IM motor that will shake without loading for V/F mode. This function applies for high speed motor. Vector type rotational auto-tuning (17-14=1) measures no-loading current of motor by inner current vector method. It avoid the problem appears oscillating current easily in V/F mode.

If execute VF type rotational auto-tuning (17-14=0) unsuccessfully, try Vector type rotational auto-tuning (17-14=1) again.

18-Slip Compensation Parameters

18-00	Slip compensation gain at low speed
Range	0.00~2.50

18-01	Slip compensation gain at high speed
Range	-1.00~1.00

18-02	Slip compensation limit
Range	0~250%

18-03	Slip compensation filter
Range	0.0~10.0 Sec

18-04	Regenerating slip compensation selection
Range	0: Disable 1: Enable

18-05	FOC delay time
Range	1~1000 msec

18-06	FOC gain
Range	0.00~2.00

Slip compensation automatically adjusts the output frequency based on the motor load to improve the speed accuracy of the motor mainly in V/F mode.

The slip compensation function compensates for the motor slip to match the actual motor speed to the reference frequency.

Slip compensation adjustment in V/F mode

18-00: Slip compensation gain at low speed

The adjustment of slip compensation gain at low speed follows the below procedure:

1. Set the rated slip and the motor no-load current (02-00).

2. Set the slip compensation (18-00) to 1.0 (factory default setting is 0.0 in V / F control mode)
3. For the operation with a load attached, measure the speed and adjust the slip gain (18-00) accordingly (increase in steps of 0.1).
 - If the motor speed is lower than frequency reference, increase the value of 18-00.
 - If the motor speed is higher than frequency reference, decrease the value of 18-00.

When the output current is greater than the no-load current (02-00), the slip compensation is enabled and the output frequency increases from f1 to f2. Refer to Figure 4.4.100., the slip compensation value is calculated as follows:

$$\text{Slip Compensation Value} = \text{Motor rated slip frequency} \times \frac{[\text{Output current (12-18)} - \text{no-load current of Motor 1 (02-00)}]}{[\text{Rated current of Motor 1(02-01)} - \text{no-load current of Motor 1 (02-00)}]}$$

$$\text{Motor Rated Slip Frequency (f)} = \frac{(\text{Motor no-load synchronous speed} - \text{Motor full load rated speed})(N) \times \text{Motor Poles (P)}}{120}$$

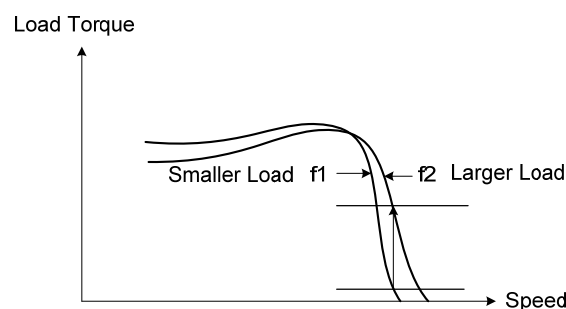

Figure 4.4.100 Slip compensation output frequency

18-02: Slip compensation limit

Sets slip compensation limit in constant torque and the constant power operation (figure 4.4.101). If 18-02 is 0%, the slip compensation limit is disabled.

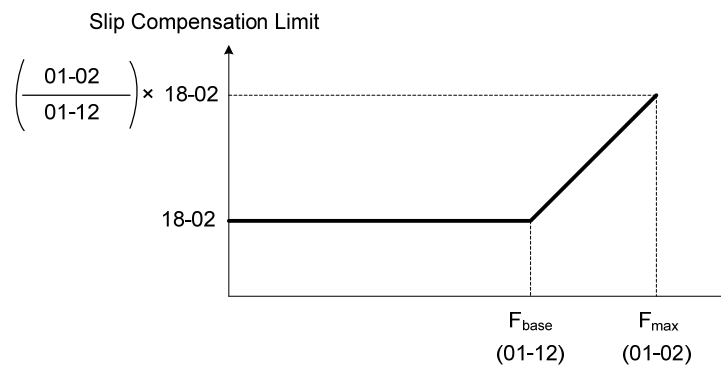

Figure 4.4.101 Slip compensation limit

When the slip compensation gain 18-00 at low speed is adjusted, and the actual motor speed is still lower than the reference frequency, the motor may be limited by the slip compensation limit.

Note: Make sure that the slip compensation limit 18-02 does not exceed the maximum allowed system limit.

18-03: Slip compensation filter

Set slip compensation filter time in V/F mode

18-04: Regenerating slip compensation selection

The selections to enable or disable the slip compensation function during regeneration.

To enable slip compensation during regeneration caused by deceleration (SLV mode), set 18-04 to 1 in case speed accuracy is required. When the slip compensation function is used regenerative energy might increase temporarily (18-04= 1) therefore a braking module might be required.

SLV mode adjustment

18-00: Slip compensation gain

- Slip compensation can be used to control the full rang speed accuracy under load condition.
- If the speed is lower than 2 Hz and the motor speed decreases, increase the value of 18-00.
- If the speed is lower than 2 Hz and the motor speed increases, reduce the value of 18-00.

Slip compensation gain uses a single value for the whole speed range. As a result the slip compensation accuracy at low speed is high but slight inaccuracies might occur at high speeds.

Adjust parameter 18-01 together with the compensation value or continue to adjust 18-00 if the speed accuracy at higher speed is not acceptable. Please note adjusting these parameters might impact the accuracy at lower speeds.

The impact of 18-00 on the torque and the speed are shown in figure 4.4.102.

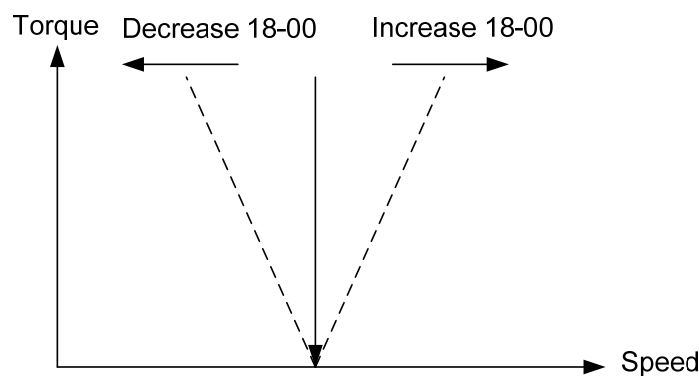

Figure 4.4.102 18-00 Effect on the torque and speed

18-01: Slip compensation gain at high speed

It is not required to adjust the Slip compensation gain at high speed if the motor is loaded. After adjusting parameter 18-00 it is recommended to increase the reference frequency and check the motor speed. In case of a speed error increase the value of 18-01 to adjust the compensation. Increase the motor rated frequency (01-12 base frequency) and increase the value of 18-01 to reduce the speed error. If the speed accuracy becomes worse due to an increase in motor temperature it is recommended to use a combination of 18-00 and 18-01 for adjustment.

Compared to 18-00, 18-01 serves as a variable gain for the full speed range. Parameter 18-01 determines the slip compensation at the motor rated speed and is calculated follows:

$$\text{Slip Compensation Gain} = (\text{Slip Compensation Gain at low speed} + \text{Slip Compensation Gain at high speed}) \times \frac{\text{Reference Frequency}}{\text{Motor rated frequency (01-12)}}$$

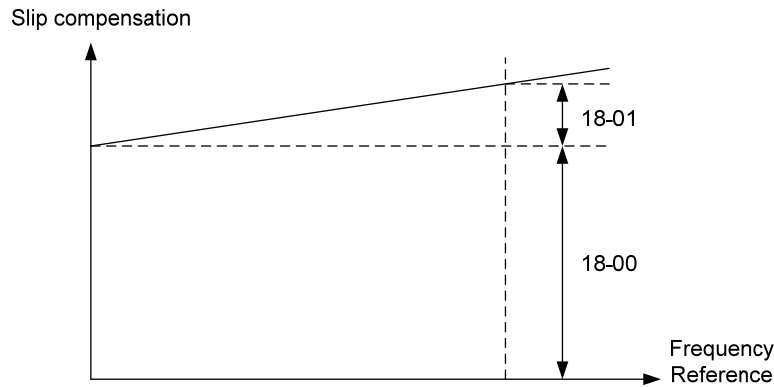

Figure 4.4.103 18-00/18-01 Slip compensation gain versus frequency reference

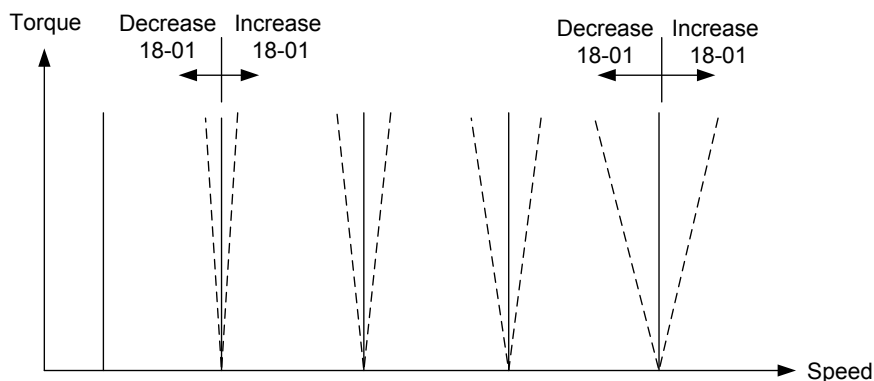

Figure 4.4.104 18-01 Effect on torque speed curve

18-05: FOC (Flux Orient Control) delay time

In the SLV mode, the slip compensation of the magnetic flux depends on the torque current and excitation current. If the motor load rises above 100% while running at the motor rated frequency, the motor voltage and resistance drops sharply, which may cause the inverter output to saturate and current jitter occur. The magnetic flux slip compensation will independently control the torque current and the excitation current to prevent current jitter. For slow speed or fixed speed operation, 18-05 may be increased. For fast operation adjust 18-06.

18-06: Slip compensation gain

If the motor is jittering at the rated frequency under full load, the value of 18-06 may gradually be reduced to zero to reduce current jitter.

SLV2 mode adjustment

Default value of parameter 18-00 is 0.0. (when 18-00 = 0.0, slip compensation function is off.)

Adjustment of slip compensation gain (18-00) is the following:

- Correctly set the rated slip and no-load current (02-00).
- Set slip compensation gain (18-00).
- Run under load. Measure the speed and adjust slip compensation gain (18-00) with the unit of 0.1.

Notes:

- If the motor speed is lower than the target speed, increase the setting value of low-speed slip compensation gain (18-00).
- If the motor speed is higher than the target speed, reduce the setting value of low-speed slip compensation gain (18-00).

19-Wobble Frequency Parameters	
19-00	Center frequency of wobble frequency
Range	5.00~100.00%
19-01	Amplitude of wobble frequency
Range	0.1~20.0%
19-03	Jump time of wobble frequency
Range	0~50 msec
19-04	Wobble frequency cycle time
Range	0.0~1000.0 Sec
19-05	Wobble frequency ratio
Range	0.1~10.0 msec
19-06	Upper offset amplitude of wobble frequency
Range	0.0~20.0 %
19-07	Lower offset amplitude of wobble frequency
Range	0.0~20.0 %

Wobble operation can be used in V/F control mode to modulate the output frequency around the reference frequency for use in winding application to create an evenly wound roll.

Refer to the figure 4.4.105 for the wobble operation and the related parameter settings.

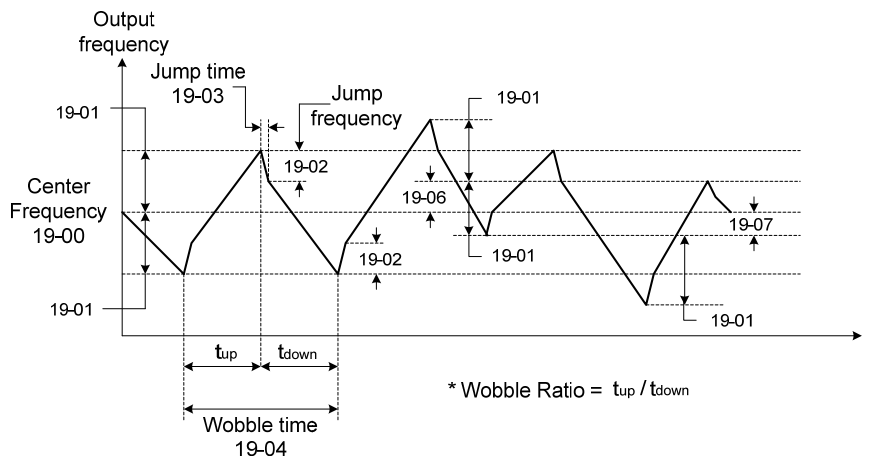

Figure 4.4.105 Wobble operation and the related parameter setting

In wobble operation, one of multifunction digital inputs (03-00 to 03-05) is set to 37 (wobble operation) and the run command is active. When the wobble operation is ready, the inverter output frequency reaches the center frequency (19-00). The acceleration time to the center frequency is the original pre-set acceleration time (Tacc 1 to Tacc 4). When the wobble operation is closed or the run command is removed, the deceleration time used is the original pre-set deceleration time (Tdec 1 to Tdec4).

In wobble operation, the inverter operates uses the in the wobble time (19-04, $t_{up} + t_{down}$) and wobble frequency (19-05, t_{up} / t_{down}).

Set multi-function digital output terminals (R1A-R1C, R2A-R2C) to output wobble operation (in acceleration) by setting from 03-11 to 03-12 to 28 or 29.

Refer to the figure 4.4.106 for the wobble ON / OFF control.

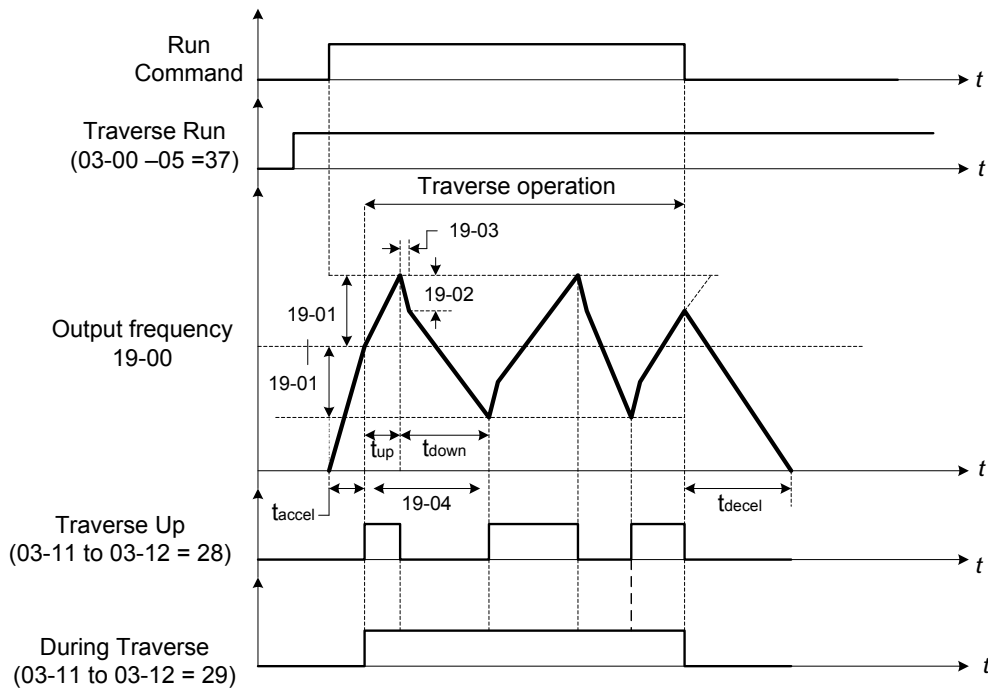

Figure 4.4.106 ON/OFF control of wobble

In wobble operation, the center frequency can be controlled by one of multi-function digital inputs.

The wobble upper and lower deviation command (03-00 to 05 = 38) and the wobble lower deviation command (03-00 to 05 = 39) cannot be active at the same time, this will result in the inverter operating at the original center frequency (19 - 00). Refer to Figure 4.4.107.

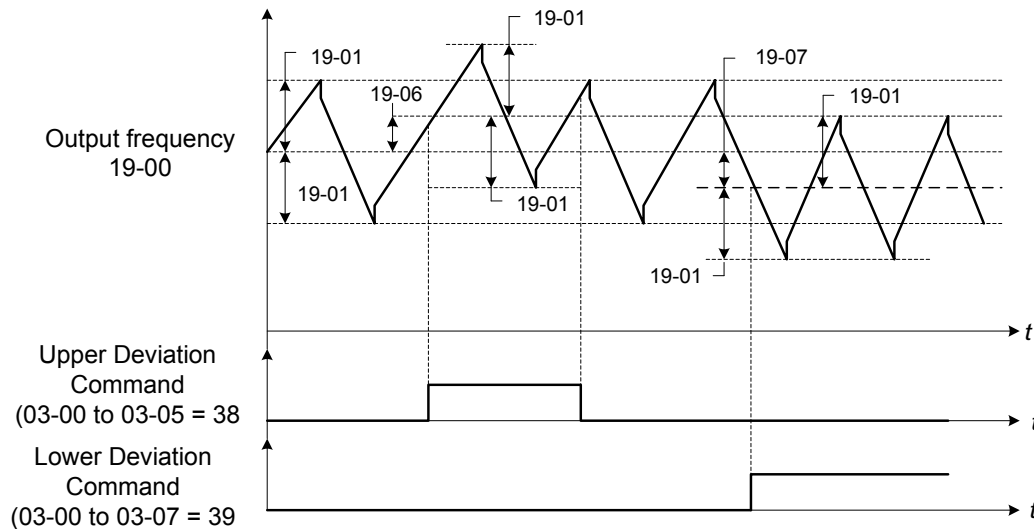

Figure 4.4.107 Upper/Lower offset operation

The wobble operation can be used during acceleration and deceleration when the stall prevention function is idle.

Select the appropriate inverter size to match the system requirement.

The wobble operation frequency range is determined by the upper limit and lower limit of the inverter frequency. If (center frequency + amplitude) is greater than the upper frequency limit, the output frequency is limited to the upper frequency limit; if (center frequency - Amplitude) is less than the lower frequency limit the output frequency is limited to the lower frequency limit.

In wobble operation, all of wobble frequency parameters (19-00 to 19-07) can be modified.

20-Speed Control Parameters

20-00	ASR gain 1
Range	0.00~250.00
20-01	ASR integral time 1
Range	0.001~10.000 Sec
20-02	ASR gain 2
Range	0.00~250.00
20-03	ASR integral time 2
Range	0.001~10.000 Sec
20-04	ASR integral time limit
Range	0~300 %
20-07	Selection of acceleration and deceleration of P/PI
Range	<p>0: PI speed control will be enabled only in constant speed. For the speed acceleration and deceleration, only use P control.</p> <p>1: Speed control is enabled either in acceleration or deceleration.</p>
20-08	ASR delay time
Range	0.000~0.500 Sec
20-09	Speed Observer Proportional(P) Gain1
Range	0.00~2.55
20-10	Speed Observer Integral(I) Time 1
Range	0.01~10.00 Sec
20-11	Speed Observer Proportional(P) Gain2
Range	0.00~2.55
20-12	Speed Observer Integral(I) Time 2
Range	0.01~10.00 Sec
20-13	Low-pass filter Time constant of speed feedback 1
Range	1~1000 msec
20-14	Low-pass filter Time constant of speed feedback 2
Range	1~1000 msec
20-15	ASR gain change frequency 1
Range	0.0~599.0 Hz
20-16	ASR gain change frequency 2
Range	0.0~599.0 Hz
20-17	Torque compensation gain at low speed
Range	0.00~2.50

20-18	Torque compensation gain at high speed
Range	-10~10%

20-33	Detection Level at Constant Speed
Range	0.1~5.0 %

Parameter 20-33 is used when 20-07 is set to 0 and frequency command source is set to analog input mode. Analog input signal, owing to the noise, will cause the system to determine the operation does not reach the constant speed so the problem may occur. Thus, adjust parameter 20-33 to avoid this situation occurring..

The following figure an overview of the automatic speed regulator (ASR) block.

SLV control mode:

The ASR function adjusts the output frequency to control the motor speed to minimize the difference between the frequency reference and actual motor speed.

The ASR controller in SLV mode uses a speed estimator to estimate the motor speed. In order to reduce speed feedback signal interference, a low-pass filter and speed feedback compensator can be enabled.

The ASR integrator output can be disabled or limited. The ASR output is passed through a low-pass filter.

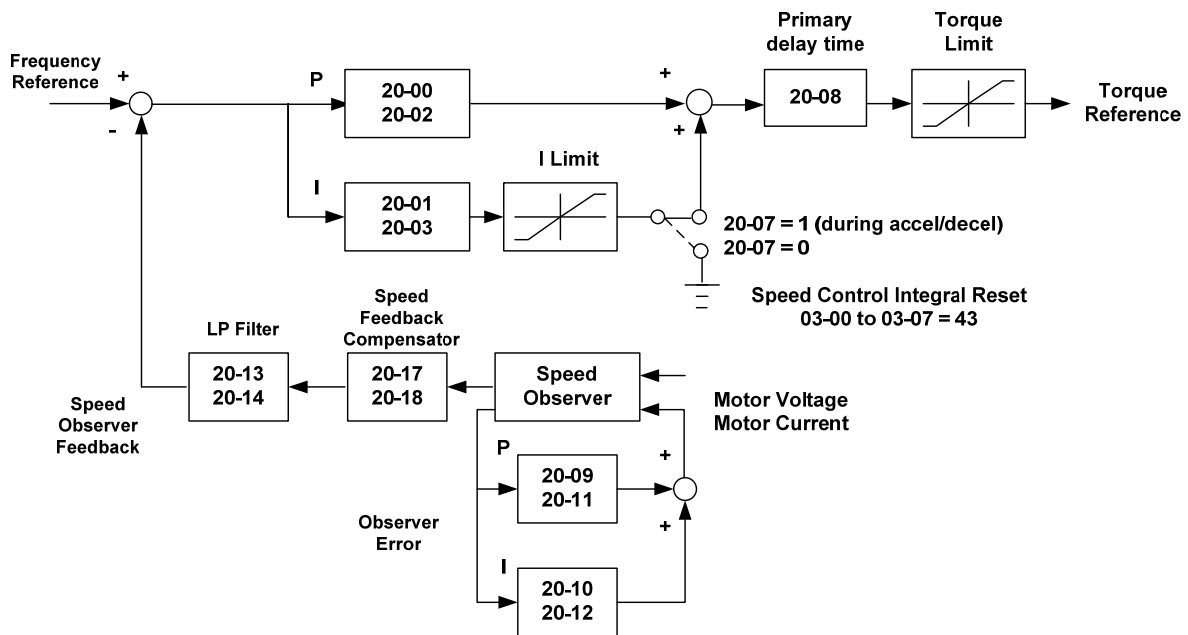

Figure 4.4.109 ASR block diagram (SLV mode)

ASR setting (SLV control mode)

In SLV mode the ASR gain is divided into a high-speed and low-speed section. The speed controller has a high-speed gain 20-00/20-01 and a low-speed gain 20-02/20-03 that can be set independently.

- The high/low switch frequency can be set with parameter 20-15 and 20-16. Similar to the ASR gain, the speed estimator has a high-speed gain 20-09/20-10 and a low-speed gain 20-11/20-12.
- The speed estimator has a low-pass filter to reduce the speed feedback interference, parameter 20-13 and 20-14 are active at high speed as well as low speed. The switch between the high-speed and the low-speed is set by parameter 20-15 and 20-16.
- 20-17 sets the low-speed compensation gain of the speed feedback.
- 20-18 sets the high-speed compensation gain of the speed feedback.
- When the frequency reference is rises above the value set in 20-16, the ASR gain used is set by parameters 20-00 and 20-01.
- When the frequency reference falls below the value set in 20-15, the ASR gain used is set by parameters 20-02 and 20-03.
- Gain time constant is adjusted linearly when the speed command falls within the range of 20-15 to 20-16, for a smooth operation.

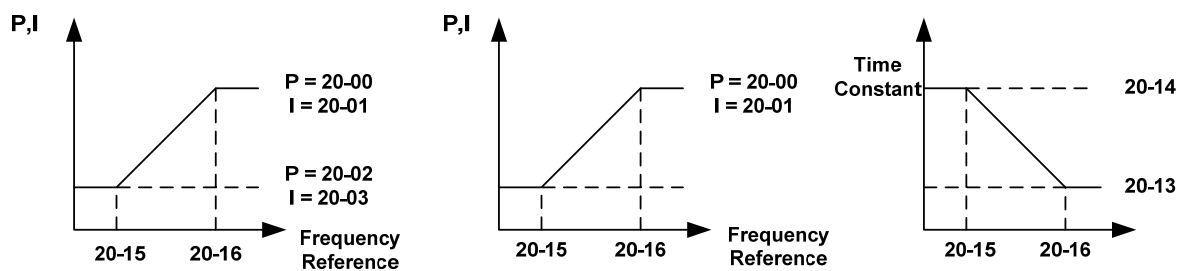

Figure 4.4.113 ASR gain setting (SLV mode)

SLV mode gain tuning (20-00~20-03, 20-09~20-18) and SLV2 mode gain tuning (20-15, 20-16)

Tune the low-speed ASR P and I gain 20-02 ~ 20-03, make sure the reference frequency is below the value of parameter 20-15.

Tune the high-speed ASR PI gain 20-00~20-01, make sure the reference frequency is above parameter 20-16 value.

Both low-speed ASR gain and the high-speed gain can be set to the same values and only require to be adjusted in case of system instability.

In case tuning of the ASR P and I gain 20-00~20-03 does not improve the system response, reduce the low-pass filter time constant 20-13~20-14 to increase the bandwidth of the feedback system and re-tune the ASR gain.

- Tune low-speed low-pass filter time constant 20-14, make sure the reference frequency is below parameter 20-15 value
- Tune high-speed low-pass filter time constant 20-13 at frequency reference, make sure the reference frequency is above parameter 20-16 value.
- Increasing the low-pass filter time constant can limit the bandwidth of the speed feedback system and may reduce the system response. Increasing the low-pass time reduces the speed feedback signal interference but may results in sluggish system response when the load suddenly changes. Adjust the low-pass filter time if the load stays fairly constant during normal operation. The low bandwidth of the speed feedback must be supported by the low gain of ASR to ensure the stable operation.

- Decreasing the low-pass filter time constant may increase the bandwidth of the speed feedback and the system response. Decreasing the low-pass time may increase the speed feedback interference resulting in system instability when the load suddenly changes. Decrease the low-pass filter time is a quick system response is required for rapidly changing loads. The high bandwidth of the speed feedback allows for a relative high ASR gain.
- In case tuning 20-00 ~ 20-03 and the low-pass filter time constant 20-13 do not improve the system response time, tuning the PI gain 20-09 ~ 20-12 of the speed estimator may be required.
- Setting a high gain for the speed estimator (high proportion (P) gain and small integral (I) time) increases the bandwidth of the speed feedback, but may cause speed feedback interference resulting in system instability.
- Setting a low gain for the speed estimator (small proportion (P) gain and high integral (I) time) decreases the bandwidth of the speed feedback, may improve speed feedback interference resulting in a more stable system.
- The default values for the ASR can be used in most applications, no adjustment is required. Adjusting the low-pass filter time and speed estimator gains requires a good understanding of the overall system. If a high-speed system response in combination with stable operation is required consider using SLV control mode.
- Parameter 20-15 sets the gain switch frequency at low-speed and parameter 20-16 sets the gain switch frequency at high-speed.
- Operating at a speed below 20-15 will result in a larger excitation current for low-speed operation accuracy. When the frequency reference rises above 20-16, the inverter will output the rated excitation current at the no-load voltage (02-19).
- For general purpose applications parameter 20-15 should be set to a value of 5 ~ 50% of the motor base frequency.
- If this value is too high, the inverter output may saturate. Parameter 20-16 should be set to a value of 4Hz or more above the value of 20-08.
- When experiencing speed jitter at high speed and stable operation during mid-range speed while operating a heavy load (>100%), it is recommended to reduce the no-load voltage (02-19) or tune the FOC parameters (18-05 ~ 18-06).
- Parameter 20-17 and 20-18 are for compensating speed feedback at low speed and high speed.
- Use parameter 20-17 to adjust the torque compensation gain for the low speed range. By tuning 20-17 an offset is added to the torque-speed curve. Increase 20-17 when the no-load speed is lower than the frequency reference. Decrease 20-17 when the no-load speed is higher than the frequency reference. The effect on the torque-speed curve from 20-17 is shown as the following figure:

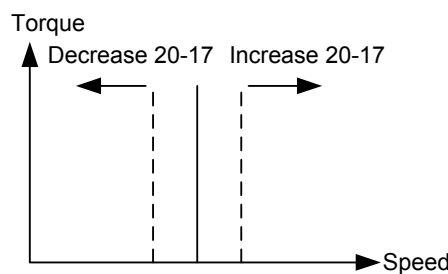

Figure 4.4.116 Effect on the torque-speed curve from 20-17

- Use parameter 20-18 to adjust the torque compensation gain for middle to high speed range. For most general purpose applications it is not necessary to adjust the 20-18. By tuning 20-18 an offset is added to the torque-speed curve. Increase 20-18 when the no-load speed is lower than the frequency reference. Decrease 20-18 when the no-load speed is higher than the frequency reference. The effect on the torque-speed curve from 20-18 is shown as the following figure 4.4.117.

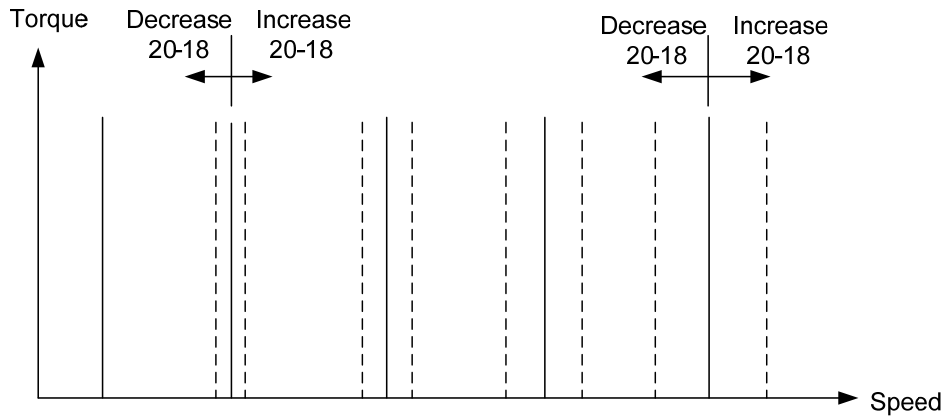

Figure 4.4.117 Effect on the torque-speed curve from 20-17

- ①. ASR main delay time (20-08).
 - a) Does not required to be adjusted for general purpose applications
 - b) When the set value of 20-08 is set high, the speed response will and therefore system response will decrease improving system stability.
- ②. ASR integral limit (20-04)
 - a) Setting a small value may prevent system response when the load suddenly changes.

20-34	Compensation Gain of Derating
Range	0~25600

This gain effect is the same as ASR proportional gain (20-00, 20-02). And if this parameter is coupled with low-pass filter time constant (20-35), it can avoid oscillation.

It is suggested that the setting value of parameter 20-34 is 30~50.

20-35	Compensation Time of Derating
Range	0~30000 mSec

This time constant is used for suppressing the oscillation produced by 20-34. But too large compensation time constant will cause slower output response and then is unfavorable for turned compensation.

It is suggested that the setting value of parameter 20-35 is 50~100ms..

Refer to Fig. 4.4.109. Torque compensation function of derating can reduce the characteristics of ASR turning around under shock load.

21-Torque And Position Control Parameters	
21-05	Positive torque limit
Range	0~300 %
21-06	Negative torque limit
Range	0~300 %
21-07	Forward regenerating torque limit
Range	0~300 %
21-08	Reversal regenerating torque limit
Range	0~300 %

Use the torque limit function to limit the torque applied to the load, or limit the regenerative torque.

In speed control the torque limit function has a higher priority than the motor speed control and compensation. This might result in extended acceleration, deceleration times and a reduction in motor speed.

Torque limit can be set in two ways:

- Use torque limit parameters (21-05 to 21-08) to set a fixed torque limit.
- Set the torque limit by using the multi-function analog input (AI2).

There are four torque limits that can be set separately, one for each quadrant:

- (I) Positive torque limit in forward direction (21-05 positive torque limit)
- (II) Positive torque limit of reverse direction (21-06 negative torque limit)
- (III) Negative torque limit in reverse direction (21-07 forward regenerating torque limit)
- (IV) Negative torque limit in forward direction (21-08 reversal regenerating torque limit)

Refer to Figure 4.4.128.

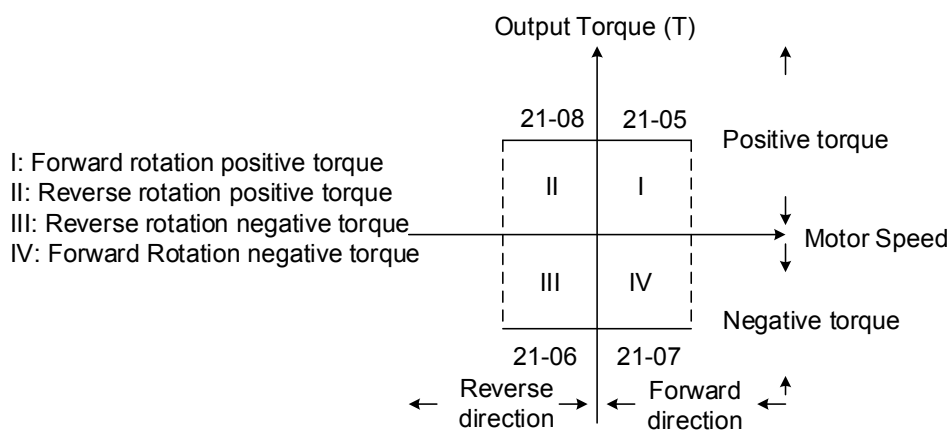

Figure 4.4.128 Torque limit setting

Torque limit setting by using multi-function analog input AI2 (04-05)

Table 4.4.39 Torque limit analog input

04-05 (AI2)	Function
11	Positive torque limit
12	Negative torque limit
13	Regenerative torque limit (for both forward and reversal directions).
14	Positive/negative torque limit (positive and negative detection torque limit)

Set the analog input terminal (AI2) signal level (04-00), gain (04-07) and bias (04-08)
The default setting for the analog input AI2 is 0 -10V representing 0 – 100% of the motor rated torque).
Figure 4.4.129 shows the relationship between the output torque and the torque limit.

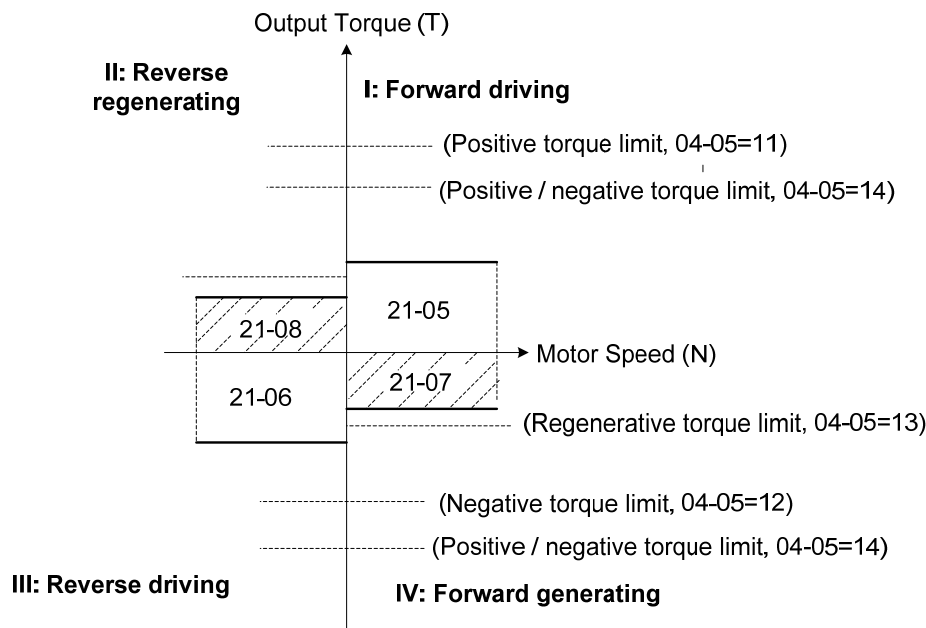

Figure 4.4.129 Analog input torque limit (AI2)

When the analog input is set to positive torque limit (value = 11) the torque limit is active in the third and fourth quadrant.in the reverse direction (regenerative torque in the second quadrant).

When the analog input is set to negative torque limit (value = 12) the torque limit is active in the third and fourth quadrant.

When the analog input is set to regenerative torque limit (value = 13) the torque limit is active in the second and fourth quadrant can be controlled.

When the analog input is set to positive/negative torque limit (value = 14) the torque limit is active in all four quadrants.

When the analog input is at maximum (10V or 20mA), the torque limit is 100% of the motor rated torque. In order to increase the torque limit above 100% the analog input gain (04-07) has to set to a value greater than 100%. For example: 200.0% of the gain will result in the torque limit of 200% of motor rated torque at 10V (20mA) analog input level.

4.4 Modbus Protocol Descriptions

4.4.1 Communication Connection and Data Frame

The inverter can communicate with a PC or PLC via RS485 using the Modbus RTU or Modbus ACSII protocol. A maximum of 84 BYTES can be received, and 80 BYTES can be sent.

Network Connection

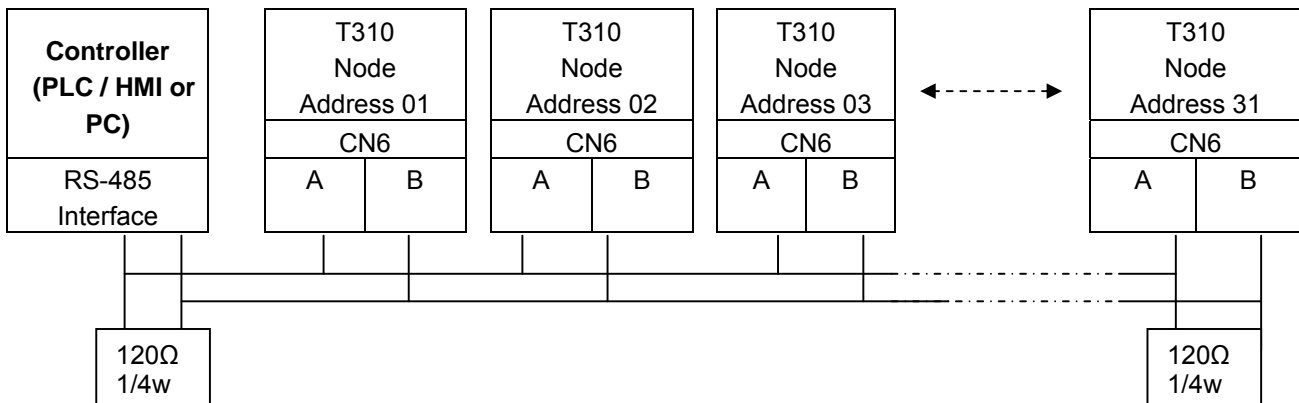

**** Terminate the communications line with a (120 ohm, 1/4 watt) resistor at both ends.**

CN6 Pin out

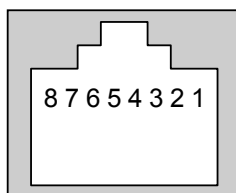

PIN	Signal	PIN	Signal
1	RS-485 A signal	5	Reserved
2	RS-485 B signal	6	RS-485 B signal
3	RS-485 A signal	7	VCC of isolated 5V power supply
4	Reserved	8	GND of isolated 5V power supply

For RS-485 communication use pin 1 or pin 3 for A and pin 2 or pin 6 for B

Data Format Frame

Data Frame for ASCII Mode

STX(3AH)	Start Bit = 3AH
Node Address Hi	Communication Address(Station):
Node Address Lo	
Function Hi	Function Code (command):
Function Lo	
Command Start Address	Command Start byte:
Command Start Address	
Command Start Address	
Command Start Address	
Data length	The length of the command:
Data length	
Data length	
Data length	
LRC Check Hi	LRC Check Code:
LRC Check Lo	
END Hi	End Byte:
END Lo	

Data Frame for RTU Mode

Master (PLC etc.) sends request to follower (inverter), and the follower sends a response to the master (PC, PLC). The data received is illustrated here.

The data length varies depending on the command (Function).

Node Address
Function Code
DATA
CRC CHECK
Signal Interval

** The inverter response time is 10ms.

Node Address

00H: Broadcast to all the drivers
 01H: to the No. 01 inverter
 0FH: to the No.15 inverter
 10H: to the No.16 inverter and so on....., max to No.31 (1FH)

Function Code

03H: Read the register contents

06H: Write a WORD to register
 08H: Loop test
 10H: Write several data to register (complex number register write)

Checksum Calculation

LRC

ex. NODE ADDRESS	01H
FUNCTION	03H
COMMAND	01H
	00H
+ DATA LENGTH	0AH

	0FH ----- 2's complement
Checksum	F1H
CS (H)	46H (ASCII)
CS (L) =	31H (ASCII)

CRC

CRC Check: CRC code covers the content from node address to DATA. Please calculate it according to the following methods.

- (1) Load a 16-bit register with FFFF hex (all 1's). Call this CRC register.
- (2) Exclusive OR the first 8-bit byte of the message, the low-order byte of the 16-bit CRC register, putting the result in the CRC register.
- (3) Shift the CRC register one bit to the right (toward the LSB), Zero-filling the MSB, Extract and examines the LSB.
- (4) (If the LSB was 0): Repeat Steps (3) (another shift)
 (If the LSB was 1): Exclusive OR the CRC register with the polynomial value A001 hex (1010 0000 0000 0001), putting the result in CRC register.
- (5) Repeat Steps (3) and (4) until 8 shifts been performed. When this is done, a complete 8-bit byte will be processed.
- (6) Repeat Steps (2) through (5) for next 8-bit byte of the message, Continue doing this until all bytes have been processed. The final content in the CRC register is the CRC value. When sending the CRC value, the Low-order byte should be sent firstly, then the High-order byte. For example, CRC value: 1241 Hex, the high-order byte should be set to 41hex and low-order byte 12hex.

CRC calculate program (C language):

```

UWORD ch_sum (UBYTE long, UBYTE *rxdbuf )
{
    BYTE i = 0;
    UWORD wkg = 0xFFFF;
    while ( long-- ) {
        wkg ^= rxdbuf++;
        for ( i = 0 ; i < 8; i++ ) {
            if ( wkg & 0x0001 ) {
                wkg = ( wkg >> 1 ) ^ 0xa001;
            }
            else {
                wkg = wkg >> 1;
            }
        }
    }
    return( wkg );
}
    
```

ASCII Mode	
STX	':'
Address	'0'
	'1'
Function	'8'
	'6'
Exception code	'5'
	'1'
LRC Check	'2'
	'8'
END	'CR'
	'LF'

RTU Mode		
Node Address	02H	
Function	83H	
Exception code	52H	
CRC-16	High	C0H
	Low	CDH

During a communication error the drive will response with an Exception Code and send a message back to the main system consisting of a Function Code that is "ANDED (and 80h)" with 80 Hex.

Exception code	Content
01	Function code error
02	Register number error
03	DATA setting error
04	Register number is over 32

4.4.2 Register and Data Format

Command Data (Read / Write)

Register No.	Bit	Content
2500H	Reserved	
2501H	0	Operation Command 1 : Run 0 : Stop
	1	Reverse Command 1 : Reverse 0 : Forward
	2	External Fault 1 : Fault
	3	Fault Reset 1 : Reset
	4	Reserved
	5	Reserved
	6	Multi-function Comm S1 1 : "ON"
	7	Multi-function Comm S2 1 : "ON"
	8	Multi-function Comm S3 1 : "ON"
	9	Multi-function Comm S4 1 : "ON"
	A	Multi-function Comm S5 1 : "ON"
	B	Multi-function Comm S6 1 : "ON"
	C	Reserved
	D	Reserved
	E	Inverter mode 1 : "ON"
F	Torque Command set by Communication 1 : "ON"	
2502H	*Frequency Command (Unit: 0.01Hz)	
2503H	Torque Command (+/-8192 corresponding to the rated torque +/-100%)	
2504H	Speed limit (+/- 120 corresponding +/-120%)	
2505H	AO1 (0.00V ~ 10.00V)	
2506H	AO2 (0 ~ 1000): Voltage (corresponding to 0.00~10.00V); Current (corresponding to 4mA~20mA)	
2507H	DO	
2508H	Reserved	
2509H	Reserved	
250AH	Reserved	
250BH	Reserved	
250CH	Reserved	
250DH	Reserved	
250EH	Reserved	
250FH	Reserved	
2510H	G12-00 H-WORD	
2511H	G12-00 L-WORD	

Note: Write in zero for Not used BIT, do not write in data for the reserved register.

Monitor Data (Read-only)

Register No.	Bit	Content
2520H	0	Operation 1 : Run 0 : Stop
	1	Direction 1 : Reverse 0 : Forward
	2	Inverter ready 1 : ready 0 : unready
	3	Fault 1 : Abnormal
	4	Warning 1 : "ON"
	5	Zero Speed 1 : "ON"
	6	380V series 1 : "ON"
	7	Frequency Agree 1 : "ON"
	8	Set Frequency Agree 1 : "ON"
	9	Frequency Detection 1 1 : "ON"
	A	Frequency Detection 2 1 : "ON"
	B	Under Voltage 1 : "ON"
	C	Baseblock 1 : "ON"
	D	Freq Ref. not from Comm. 1 : "ON"
	E	Seq. not from Comm. 1 : "ON"
	F	Over Torque 1 : "ON"
2521H	0	30
	1	UV 31
	2	OC 32
	3	OV 33
	4	OH1 34
	5	OL1 35
	6	OL2 36
	7	OT 37
	8	UT 38 CF07
	9	SC 39
	10	Ground OC 40
	11	Reserved 41 Reserved
	12	Input Phase Loss 42
	13	Output Phase Loss 43
	14	Reserved 44
	15	Reserved 45
	16	Reserved 46
	17	External Fault 01 47 SS1
	18	External Fault 02 48 Reserved
	19	External Fault 03 49 RUN
	20	External Fault 04 50 OCA
	21	External Fault 05 51 OCD
	22	External Fault 06 52 OCC
	23	Reserved 53 Reserved
	24	Reserved 54
	25	FB 55
	26	Reserved 56
	27	57

4-241

		28	CE		58				
		29	STO		59				
		30	Reserved		61				
2522H	DI State	0	Terminal S1						
		1	Terminal S2						
		2	Terminal S3						
		3	Terminal S4						
		4	Terminal S5						
		5	Terminal S6						
		6	Reserved						
		7	Reserved						
		8	Reserved						
		9	Reserved						
		A	Reserved						
		B	Reserved						
		C	Reserved						
		D	Reserved						
		E	Reserved						
F	Reserved								
2523H		Frequency command (0.01Hz)							
2524H		Output frequency (0.01Hz)							
2525H		Reserved							
2526H		DC voltage command (0.1V)							
2527H		Output current (0.1A)							
2528H	Warning Description	0	No alarm	20	EF4	40	EF	60	Reserved
		1	OV	21	EF5	41	Reserved	61	RETRY
		2	UV	22	EF6	42	Reserved	62	Reserved
		3	OL2	23	Reserved	43	Reserved	63	Reserved
		4	OH2	24	Reserved	44	Reserved	64	Reserved
		5	Reserved	25	Reserved	45	OL1	65	OH1
		6	OT	26	CLB	46	HP_ER	66	FIRE
		7	Reserved	27	Reserved	47	SE10	67	ES
		8	Reserved	28	CT	48	Reserved	68	STP1
		9	UT	29	USP	49	BB1	69	BDERR
		10	Reserved	30	Reserved	50	BB2	70	EPERR
		11	Reserved	31	Reserved	51	BB3	71	ADCER
		12	Reserved	32	FB	52	BB4	72	Reserved
		13	CE	33	Reserved	53	BB5	73	STP0
		14	CALL	34	SE01	54	BB6	74	Reserved
		15	Reserved	35	SE02	55	Reserved	75	STP2
		16	EF0	36	SE03	56	Reserved	76	RUNER
		17	EF1	37	Reserved	57	Reserved		
		18	EF2	38	SE05	58	Reserved		
19	EF3	39	HPERR	59	Reserved				
2529H		Digital Output State							
252AH		AO1 (0.00V ~ 10.00V)							

252BH		AO2 (0 ~ 1000): Voltage (corresponding to 0.00~10.00V); Current (corresponding to 4mA~20mA)
252CH		Analog Input 1 (0.1%)
252DH		Analog Input 2 (0.1%)
252EH		Reserved
252FH		L510(s)/ E510/ A510(s)/ F510/T310 Check (0x600)

Note: Write in zero for Not used BIT, do not write in data for the reserved register.

Read Holding Register [03H]

Read consecutive holding registers. The address of the first holding register is specified in the protocol
 Example: Read frequency command from the inverter with node address 1.

ASCII Mode

Command Message

3AH	STX
30H	Node Address
31H	
30H	Function
33H	
30H	Starting Register
31H	
32H	
33H	
30H	Number of Registers
30H	
30H	
31H	
?	LRC CHECK
?	
0DH	END
0AH	

Response Message (Normal)

3AH	STX
30H	Node Address
31H	
30H	Function
33H	
30H	Data Length
32H	
31H	Initial Save Register
37H	
37H	
30H	
?	LRC CHECK
?	
0DH	END
0AH	

Response Message (Error)

3AH	STX
30H	Node Address
31H	
38H	Function
33H	
30H	Exception code
34H	
34H	LRC CHECK
30H	
0DH	END
0AH	

RTU Mode

Command Message

Node Address	01 H	
Function	03H	
Starting Register	High	0CH
	Low	10H
Number of Registers	High	00H
	Low	01H
CRC-16	High	86H
	Low	9FH

Response Message (Normal)

Node Address	01H	
Function	03H	
Data Length	02H	
Initial Save Register	High	17H
	Low	70H
CRC-16	High	B6H
	Low	50H

Response Message (Error)

Node Address	01H	
Function	83H	
Exception code	04H	
CRC-16	High	40H
	Low	F3H

Loop back test [08H]

Check the communication between the master and the follower (inverter). The data used can be arbitrary.

ASCII Mode

Command Message

3AH	STX
30H	Node Address
31H	
30H	Function
38H	
30H	Test Code
30H	
30H	
30H	
41H	DATA
35H	
33H	
37H	
31H	LRC CHECK
42H	
0DH	END
0AH	

Response Message (Normal)

3AH	STX
30H	Node Address
31H	
30H	Function
38H	
30H	Test Code
30H	
30H	
30H	
41H	DATA
35H	
33H	
37H	
31H	LRC CHECK
42H	
0DH	END
0AH	

Response Message (Error)

3AH	STX
30H	Node Address
31H	
38H	Function
38H	
30H	Exception code
33H	
30H	LRC CHECK
36H	
0DH	END
0AH	

RTU Mode

Command Message

Node Address	01 H	
Function	08H	
Test Code	High	00H
	Low	00H
DATA	High	A5H
	Low	37H
CRC-16	High	DAH
	Low	8DH

Response Message (Normal)

Node Address	01H	
Function	08H	
Test Code	High	00H
	Low	00H
DATA	High	A5H
	Low	37H
CRC-16	High	DAH
	Low	8DH

Response Message (Error)

Node Address	01H	
Function	88H	
Exception code	03H	
CRC-16	High	06H
	Low	01H

Write Single Holding Register [06H]

Write single holding register. The register address of the holding register is specified in the message.

Example: Write a 60.00Hz frequency command to node address 1.

ASCII Mode

Command Message

3AH	STX
30H	Node Address
31H	
30H	Function
36H	
32H	Starting Register
35H	
30H	
32H	
31H	DATA
37H	
37H	
30H	
34H	LRC CHECK
42H	
0DH	END
0AH	

Response Message (Normal)

3AH	STX
30H	Node Address
31H	
30H	Function
36H	
32H	Starting Register
35H	
30H	
32H	
31H	DATA
37H	
37H	
30H	
34H	LRC CHECK
42H	
0DH	END
0AH	

Response Message (Error)

3AH	STX
30H	Node Address
31H	
38H	Function
36H	
30H	Exception code
33H	
30H	LRC CHECK
32H	
0DH	END
0AH	

RTU Mode

Command Message

Node Address	01 H	
Function	06H	
Start No	High	25H
	Low	02H
DATA	High	17H
	Low	70H
CRC-16	High	2DH
	Low	12H

Response Message (Normal)

Node Address	01H	
Function	06H	
Start No	High	25H
	Low	02H
DATA	High	17H
	Low	70H
CRC-16	High	2DH
	Low	12H

Response Message (Error)

Node Address	01H	
Function	86H	
Exception code	03H	
CRC-16	High	02H
	Low	61H

Write Multiple Holding Register [10H]

Write multiple holding registers. The address of the first holding register is specified in the message.

Example: Write a 60.00Hz frequency command to node address 1 and enable FWD run command.

ASCII Mode

Command Message

3AH	STX
30H	Node Address
31H	
31H	Function
30H	
30H	Starting Register
31H	
30H	
31H	
30H	Number of Registers
30H	
30H	
32H	
30H	Number of Bytes*
34H	
30H	DATA 1
30H	
30H	
31H	
31H	DATA 2
37H	
37H	
30H	
33H	LRC CHECK
42H	
0DH	END
0AH	

Response Message (Normal)

3AH	STX
30H	Node Address
31H	
31H	Function
30H	
32H	Starting Register
35H	
30H	
31H	
30H	Number of Registers
30H	
30H	
32H	
43H	LRC CHECK
37H	
0DH	END
0AH	

Response Message (Error)

3AH	STX
30H	Node Address
31H	
39H	Function
30H	
30H	Exception code
33H	
30H	
43H	LRC CHECK
0DH	
0AH	END

* Number of bytes is register amount x 2

RTU Mode

Command Message

Node Address		01H
Function		10H
Starting Register	High	25H
	Low	01H
Number of Registers	High	00H
	Low	02H
Number of Bytes*		04H
DATA 1	High	00H
	Low	01H
DATA 2	High	17H
	Low	70H
CRC-16	High	60H
	Low	27H

Response Message (Normal)

Node Address		01H
Function		10H
Starting Register	High	25H
	Low	01H
Number of Registers	High	00H
	Low	02H
CRC-16	High	1BH
	Low	04H

Response Message (Error)

Node Address		01H
Function		90H
Exception code		03H
CRC-16	High	0CH
	Low	01H

* Data amount is register amount x 2

Function	Register No	Function	Register No	Function	Register No
Group 2		Group 3		Group 3	
2 - 00	0200H	3 - 00	0300H	3 - 44	032CH
2 - 01	0201H	3 - 01	0301H	3 - 45	032DH
2 - 02	0202H	3 - 02	0302H	3 - 46	032EH
2 - 03	0203H	3 - 03	0303H	3 - 47	032FH
2 - 04	0204H	3 - 04	0304H	3 - 48	0330H
2 - 05	0205H	3 - 05	0305H	3 - 49	0331H
2 - 06	0206H	3 - 06	Reserved		
2 - 07	0207H	3 - 07	Reserved		
2 - 08	0208H	3 - 08	0308H		
2 - 09	0209H	3 - 09	0309H		
2 - 10	020AH	3 - 10	030AH		
2 - 11	020BH	3 - 11	030BH		
2 - 12	020CH	3 - 12	030CH		
2 - 13	020DH	3 - 13	030DH		
2 - 14	020EH	3 - 14	030EH		
2 - 15	020FH	3 - 15	030FH		
2 - 16	0210H	3 - 16	0310H		
2 - 17	0211H	3 - 17	0311H		
2 - 18	0212H	3 - 18	0312H		
2 - 19	0213H	3 - 19	0313H		
2 - 20	0214H	3 - 20	0314H		
2 - 21	0215H	3 - 21	0315H		
2 - 22	0216H	3 - 22	0316H		
2 - 23	0217H	3 - 23	0317H		
2 - 24	0218H	3 - 24	0318H		
2 - 25	0219H	3 - 25	0319H		
2 - 26	021AH	3 - 26	031AH		
2 - 27	021BH	3 - 27	031BH		
2 - 28	021CH	3 - 28	031CH		
2 - 29	021DH	3 - 29	031DH		
2 - 30	021EH	3 - 30	031EH		
2 - 31	021FH	3 - 31	031FH		
2 - 32	0220H	3 - 32	0320H		
2 - 33	0221H	3 - 33	0321H		
2 - 34	0222H	3 - 34	0322H		
2 - 35	0223H	3 - 35	0323H		
2 - 36	0224H	3 - 36	0324H		
2 - 37	0225H	3 - 37	0325H		
		3 - 38	0326H		
		3 - 39	0327H		
		3 - 40	0328H		
		3 - 41	0329H		
		3 - 42	032AH		
		3 - 43	032BH		

Function	Register No	Function	Register No	Function	Register No
Group 4		Group 5		Group 5	
4 – 00	0400H	5 – 00	0500H	5 – 33	0521H
4 – 01	0401H	5 – 01	0501H	5 – 34	0522H
4 – 02	0402H	5 – 02	0502H	5 – 35	0523H
4 – 03	0403H	5 – 03	0503H	5 – 36	0524H
4 – 04	0404H	5 – 04	0504H	5 – 37	0525H
4 – 05	0405H	5 – 05	0505H	5 – 38	0526H
4 – 06	0406H	5 – 06	0506H	5 – 39	0527H
4 – 07	0407H	5 – 07	0507H	5 – 40	0528H
4 – 08	0408H	5 – 08	0508H	5 – 41	0529H
4 – 09	0409H	5 – 09	0509H	5 – 42	052AH
4 – 10	040AH	5 – 10	050AH	5 – 43	052BH
4 – 11	040BH	5 – 11	050BH	5 – 44	052CH
4 – 12	040CH	5 – 12	050CH	5 – 45	052DH
4 – 13	040DH	5 – 13	050DH	5 – 46	052EH
4 – 14	040EH	5 – 14	050EH	5 – 47	052FH
4 – 15	040FH	5 – 15	050FH	5 – 48	0530H
4 – 16	0410H	5 – 16	0510H		
4 – 17	0411H	5 – 17	0511H		
4 – 18	0412H	5 – 18	0512H		
4 – 19	0413H	5 – 19	0513H		
4 – 20	0414H	5 – 20	0514H		
		5 – 21	0515H		
		5 – 22	0516H		
		5 – 23	0517H		
		5 – 24	0518H		
		5 – 25	0519H		
		5 – 26	051AH		
		5 – 27	051BH		
		5 – 28	051CH		
		5 – 29	051DH		
		5 – 30	051EH		
		5 – 31	051FH		
		5 – 32	0520H		

Function	Register No	Function	Register No	Function	Register No
Group 6		Group 6		Group 7	
6 - 00	0600H	6 - 41	0629H	7 - 00	0700H
6 - 01	0601H	6 - 42	062AH	7 - 01	0701H
6 - 02	0602H	6 - 43	062BH	7 - 02	0702H
6 - 03	0603H	6 - 44	062CH	7 - 03	0703H
6 - 04	0604H	6 - 45	062DH	7 - 04	0704H
6 - 05	0605H	6 - 46	062EH	7 - 05	0705H
6 - 06	0606H	6 - 47	062FH	7 - 06	0706H
6 - 07	0607H			7 - 07	0707H
6 - 08	0608H			7 - 08	0708H
6 - 09	0609H			7 - 09	0709H
6 - 10	060AH			7 - 10	070AH
6 - 11	060BH			7 - 11	070BH
6 - 12	060CH			7 - 12	070CH
6 - 13	060DH			7 - 13	070DH
6 - 14	060EH			7 - 14	070EH
6 - 15	060FH			7 - 15	070FH
6 - 16	0610H			7 - 16	0710H
6 - 17	0611H			7 - 17	0711H
6 - 18	0612H			7 - 18	0712H
6 - 19	0613H			7 - 19	0713H
6 - 20	0614H			7 - 20	0714H
6 - 21	0615H			7 - 21	0715H
6 - 22	0616H			7 - 22	0716H
6 - 23	0617H			7 - 23	0717H
6 - 24	0618H			7 - 24	0718H
6 - 25	0619H			7 - 25	0719H
6 - 26	061AH			7 - 26	071AH
6 - 27	061BH			7 - 27	071BH
6 - 28	061CH			7 - 28	071CH
6 - 29	061DH			7 - 29	071DH
6 - 30	061EH			7 - 30	071EH
6 - 31	061FH			7 - 31	071FH
6 - 32	0620H			7 - 32	0720H
6 - 33	0621H			7 - 33	0721H
6 - 34	0622H			7 - 34	0722H
6 - 35	0623H			7 - 35	0723H
6 - 36	0624H			7 - 36	0724H
6 - 37	0625H			7 - 42	072AH
6 - 38	0626H				
6 - 39	0627H				
6 - 40	0628H				

Function	Register No	Function	Register No	Function	Register No
Group 8		Group 9		Group 10	
8 - 00	0800H	9 - 00	0900H	10 - 00	0A00H
8 - 01	0801H	9 - 01	0901H	10 - 01	0A01H
8 - 02	0802H	9 - 02	0902H	10 - 02	0A02H
8 - 03	0803H	9 - 03	0903H	10 - 03	0A03H
8 - 04	0804H	9 - 04	0904H	10 - 04	0A04H
8 - 05	0805H	9 - 05	0905H	10 - 05	0A05H
8 - 06	0806H	9 - 06	0906H	10 - 06	0A06H
8 - 07	0807H	9 - 07	0907H	10 - 07	0A07H
8 - 08	0808H	9 - 08	0908H	10 - 08	0A08H
8 - 09	0809H	9 - 09	0909H	10 - 09	0A09H
8 - 10	080AH			10 - 10	0A0AH
8 - 11	080BH			10 - 11	0A0BH
8 - 12	080CH			10 - 12	0A0CH
8 - 13	080DH			10 - 13	0A0DH
8 - 14	080EH			10 - 14	0A0EH
8 - 15	080FH			10 - 15	0A0FH
8 - 16	0810H			10 - 16	0A10H
8 - 17	0811H			10 - 17	0A11H
8 - 18	0812H			10 - 18	0A12H
8 - 19	0813H			10 - 19	0A13H
8 - 20	0814H			10 - 20	0A14H
8 - 21	0815H			10 - 21	0A15H
8 - 22	0816H			10 - 22	0A16H
8 - 23	0817H			10 - 23	0A17H
8 - 24	0818H			10 - 24	0A18H
8 - 25	0819H			10 - 25	0A19H
8 - 26	081AH			10 - 26	0A1AH
8 - 27	081BH			10 - 27	0A1BH
8 - 28	081CH			10 - 28	0A1CH
8 - 29	081DH			10 - 29	0A1DH
8 - 30	081EH			10 - 30	0A1EH
8 - 31	081FH			10 - 31	0A1FH
8 - 32	0820H			10 - 32	0A20H
8 - 33	0821H			10 - 33	0A21H
8 - 34	0822H			10 - 34	0A22H
8 - 35	0823H			10 - 35	0A23H
8 - 36	0824H			10 - 36	0A24H
8 - 37	0825H			10 - 37	0A25H
8 - 38	0826H			10 - 38	0A26H
8 - 39	0827H			10 - 39	0A27H
8 - 40	0828H			10 - 40	0A28H
8 - 41	0829H			10 - 41	0A29H
8 - 42	082AH				
8 - 43	082BH				
8 - 44	082CH				

Function	Register No	Function	Register No	Function	Register No
Group 11		Group 11		Group 12	
11 - 00	0B00H	11 - 44	0B2CH	12 - 00	High WORD: 2510H Low WORD: 2511H
11 - 01	0B01H	11 - 45	0B2DH	12 - 01	0C01H
11 - 02	0B02H	11 - 46	0B2EH	12 - 02	0C02H
11 - 03	0B03H	11 - 47	0B2FH	12 - 03	0C03H
11 - 04	0B04H	11 - 48	0B30H	12 - 04	0C04H
11 - 05	0B05H	11 - 49	0B31H	12 - 05	0C05H
11 - 06	0B06H	11 - 50	0B32H	12 - 06	0C06H
11 - 07	0B07H	11 - 51	0B33H	12 - 07	0C07H
11 - 08	0B08H	11 - 52	0B34H	12 - 08	0C08H
11 - 09	0B09H	11 - 53	0B35H	12 - 09	0C09H
11 - 10	0B0AH	11 - 54	0B36H	12 - 10	0C0AH
11 - 11	0B0BH	11 - 55	0B37H	12 - 11	0C0BH
11 - 12	0B0CH	11 - 56	0B38H	12 - 12	0C0CH
11 - 13	0B0DH	11 - 57	0B39H	12 - 13	0C0DH
11 - 14	0B0EH	11 - 58	0B3AH	12 - 14	0C0EH
11 - 15	0B0FH	11 - 59	0B3BH	12 - 15	0C0FH
11 - 16	0B10H	11 - 60	0B3CH	12 - 16	0C10H
11 - 17	0B11H	11 - 61	0B3DH	12 - 17	0C11H
11 - 18	0B12H	11 - 62	0B3EH	12 - 18	0C12H
11 - 19	0B13H	11 - 63	0B3FH	12 - 19	0C13H
11 - 20	0B14H	11 - 64	0B40H	12 - 20	0C14H
11 - 21	0B15H	11 - 65	0B41H	12 - 21	0C15H
11 - 22	0B16H	11 - 66	0B42H	12 - 22	0C16H
11 - 23	0B17H	11 - 67	0B43H	12 - 23	0C17H
11 - 24	0B18H	11 - 68	0B44H	12 - 24	0C18H
11 - 25	0B19H	11 - 69	0B45H	12 - 25	0C19H
11 - 26	0B1AH	11 - 70	0B46H	12 - 26	0C1AH
11 - 27	0B1BH	11 - 71	0B47H	12 - 27	0C1BH
11 - 28	0B1CH	11 - 72	0B48H	12 - 28	0C1CH
11 - 29	0B1DH	11 - 73	0B49H	12 - 29	0C1DH
11 - 30	0B1EH			12 - 30	0C1EH
11 - 31	0B1FH			12 - 31	0C1FH
11 - 32	0B20H			12 - 32	0C20H
11 - 33	0B21H			12 - 33	0C21H
11 - 34	0B22H			12 - 34	0C22H
11 - 35	0B23H			12 - 35	0C23H
11 - 36	0B24H			12 - 36	0C24H
11 - 37	0B25H			12 - 37	0C25H
11 - 38	0B26H			12 - 38	0C26H
11 - 39	0B27H			12 - 39	0C27H
11 - 40	0B28H			12 - 40	0C28H
11 - 41	0B29H			12 - 41	0C29H
11 - 42	0B2AH			12 - 42	0C2AH
11 - 43	0B2BH			12 - 43	0C2BH

Function	Register No	Function	Register No	Function	Register No
Group 12		Group 13		Group 13	
12 – 44	0C2CH	13 – 00	0D00H	13 – 44	0D2CH
12 – 45	0C2DH	13 – 01	0D01H	13 – 45	0D2DH
12 – 46	0C2EH	13 – 02	0D02H	13 – 46	0D2EH
12 – 47	0C2FH	13 – 03	0D03H	13 – 47	0D2FH
12 – 48	0C30H	13 – 04	0D04H	13 – 48	0D30H
12 – 49	0C31H	13 – 05	0D05H	13 – 49	0D31H
12 – 50	0C32H	13 – 06	0D06H	13 – 50	0D32H
12 – 51	0C33H	13 – 07	0D07H	13 – 46	0D2EH
12 – 52	0C34H	13 – 08	0D08H	13 – 47	0D2FH
12 – 53	0C35H	13 – 09	0D09H	13 – 48	0D30H
12 – 54	0C36H	13 – 10	0D0AH	13 – 49	0D31H
12 – 55	0C37H	13 – 11	0D0BH	13 – 50	0D32H
12 – 56	0C38H	13 – 12	0D0CH		
12 – 57	0C39H	13 – 13	0D0DH		
12 – 58	0C3AH	13 – 14	0D0EH		
12 – 59	0C3BH	13 – 15	0D0FH		
12 – 60	0C3CH	13 – 16	0D10H		
12 – 61	0C3DH	13 – 17	0D11H		
12 – 62	0C3EH	13 – 18	0D12H		
12 – 63	0C3FH	13 – 19	0D13H		
12 – 64	0C40H	13 – 20	0D14H		
12 – 65	0C41H	13 – 21	0D15H		
12 – 66	0C42H	13 – 22	0D16H		
12 – 67	0C43H	13 – 23	0D17H		
12 – 68	0C44H	13 – 24	0D18H		
12 – 69	0C45H	13 – 25	0D19H		
12 – 70	0C46H	13 – 26	0D1AH		
12 – 71	0C47H	13 – 27	0D1BH		
12 – 72	0C48H	13 – 28	0D1CH		
12 – 73	0C49H	13 – 29	0D1DH		
12 – 74	0C4AH	13 – 30	0D1EH		
12 – 75	0C4BH	13 – 31	0D1FH		
12 – 76	0C4CH	13 – 32	0D20H		
12 – 77	0C4DH	13 – 33	0D21H		
12 – 78	0C4EH	13 – 34	0D22H		
12 – 79	0C4FH	13 – 35	0D23H		
12 – 80	0C50H	13 – 36	0D24H		
		13 – 37	0D25H		
		13 – 38	0D26H		
		13 – 39	0D27H		
		13 – 40	0D28H		
		13 – 41	0D29H		
		13 – 42	0D2AH		
		13 – 43	0D2BH		

Function	Register No	Function	Register No	Function	Register No
Group 19		Group 20		Group 21	
19 – 00	1300H	20 – 00	1400H	21 – 00	1500H
19 – 01	1301H	20 – 01	1401H	21 – 01	1501H
19 – 02	1302H	20 – 02	1402H	21 – 02	1502H
19 – 03	1303H	20 – 03	1403H	21 – 03	1503H
19 – 04	1304H	20 – 04	1404H	21 – 04	1504H
19 – 05	1305H	20 – 05	1405H	21 – 05	1505H
19 – 06	1306H	20 – 06	1406H	21 – 06	1506H
19 – 07	1307H	20 – 07	1407H	21 – 07	1507H
		20 – 08	1408H	21 – 08	1508H
		20 – 09	1409H		
		20 – 10	140AH		
		20 – 11	140BH		
		20 – 12	140CH		
		20 – 13	140DH		
		20 – 14	140EH		
		20 – 15	140FH		
		20 – 16	1410H		
		20 – 17	1411H		
		20 – 18	1412H		
		20 – 19	1413H		
		20 – 20	1414H		
		20 – 21	1415H		
		20 – 22	1416H		
		20 – 23	1417H		
		20 – 24	1418H		
		20 – 25	1419H		
		20 – 26	141AH		
		20 – 27	141BH		
		20 – 28	141CH		
		20 – 29	141DH		
		20 – 30	141EH		
		20 – 31	141FH		
		20 – 32	1420H		
		20 – 33	1421H		
		20 – 34	1422H		
		20 – 35	1423H		

Chapter 5 Troubleshooting and Fault Diagnostics

5.1 General

Inverter fault detection and early warning / self-diagnosis function. When the inverter detects a fault, a fault message is displayed on the keypad. The fault contact output energizes and the motor will coast to stop (The stop method can be selected for specific faults).

When the inverter detects a warning / self-diagnostics error, the digital operator will display a warning or self-diagnostic code, the fault output does not energize in this case. Once the warning is removed, the system will automatically return to its original state.

5.2 Fault Detection Function

When a fault occurs, please refer to Table 5.1 for possible causes and take appropriate measures.







Use one of the following methods to restart:

1. Set one of multi-function digital input terminals (03-00, 03-05) to 17 (Fault reset); activate input
2. Press the reset button on the keypad.
3. Power down inverter wait until keypad goes blank and power-up the inverter again.









When a fault occurs, the fault message is stored in the fault history (see group 12 parameters).

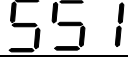
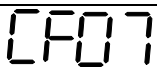
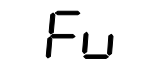

Table 5.1 Fault information and possible solutions

LED display	Description	Cause	Possible solutions
OC over current OC	The inverter output current exceeds the overcurrent level in stop state.	<ul style="list-style-type: none"> •The motor cable is broken, the motor coil is damaged, the current sensor is failed, and the inverter is damaged. 	<ul style="list-style-type: none"> • Disconnect motor and try running inverter. • Return the inverter
OCA over current OCA	The inverter output current exceeds the overcurrent level (200% of the inverter rated current) in acceleration time	<ul style="list-style-type: none"> •Acceleration time is too short •Capacity of motor is bigger than inverter •Short circuit between winding and shell of motor •Short circuit between wire and ground of motor •The motor cable is broken, the motor coil is damaged, and the inverter is damaged. 	<ul style="list-style-type: none"> •Set the longer acceleration time •Change to bigger capacity of inverter •Examine motor •Check the wire •Return the inverter
OCC over current OCC	The inverter output current exceeds the overcurrent level in constant speed	<ul style="list-style-type: none"> •Instantaneous change of load •Instantaneous change of current •The motor cable is broken, the motor coil is damaged, and the inverter is damaged. 	<ul style="list-style-type: none"> •Change to bigger capacity of inverter •Add reactor to power source •Return the inverter

LED display	Description	Cause	Possible solutions
OCd over current 	The inverter output current exceeds the overcurrent level in deceleration time	<ul style="list-style-type: none"> • Deceleration time is too short • The motor cable is broken, the motor coil is damaged, and the inverter is damaged. 	<ul style="list-style-type: none"> • Set the longer acceleration time • Return the inverter
SC short circuit 	Inverter output short circuit or ground fault.	<ul style="list-style-type: none"> • Short circuit or ground fault (08-23 = 1). • Motor damaged (insulation). • Wire damage or deterioration. 	<ul style="list-style-type: none"> • Check the motor wiring. • Return the inverter
GF Ground fault 	The current to ground exceeds 50% of the inverter rated output current (08-23 = 1, GF function is enabled).	<ul style="list-style-type: none"> • Motor damaged (insulation). • Wire damage or deterioration. • Inverter DCCT sensors defect. 	<ul style="list-style-type: none"> • Replace motor. • Check the motor wiring. • Disconnect motor and try running inverter. • Check resistance between cables and ground. • Reduce carrier frequency. • Return the inverter
OV Over voltage 	DC bus voltage exceeds the OV detection level: 820Vdc	<ul style="list-style-type: none"> • Deceleration time set too short, resulting in regenerative energy flowing back from motor to the inverter. • The inverter input voltage is too high. • Use of power factor correction capacitors. • Excessive braking load. • Braking transistor or resistor defective. • Speed search parameters set incorrectly. 	<ul style="list-style-type: none"> • Increase deceleration time • Reduce input voltage to comply with the input voltage requirements or install an AC line reactor to lower the input voltage. • Remove the power factor correction capacitor. • Use dynamic braking unit. • Replace braking transistor or resistor. • Adjust speed search parameters.
UV Under voltage 	DC bus voltage is lower than the UV detection level or the pre-charge contactor is not active while the inverter is running. 380V class: 380Vdc (The detection value can be adjusted by 07-13).	<ul style="list-style-type: none"> • The input voltage is too low. • Input phase loss. • Acceleration time set too short. • Input voltage fluctuation. • Pre-charge contactor damaged. • DC bus voltage feedback signal value not incorrect. • Inverter damaged. 	<ul style="list-style-type: none"> • Check the input voltage. • Check input wiring. • Increase acceleration time. • Check power source • Replace pre-charge contactor • Return the inverter
IPL input phase loss 	Phase loss at the input side of the inverter or input voltage imbalance, active when 08-09 = 1 (enabled).	<ul style="list-style-type: none"> • Wiring loose in inverter input terminal. • Momentary power loss. • Input voltage imbalance. • The main circuit capacitor in the inverter aged. 	<ul style="list-style-type: none"> • Check input wiring / faster screws. • Check power supply. • Return the inverter
OPL output phase loss 	Phase loss at the output side of the inverter, active when 08-10 = 1 (enabled).	<ul style="list-style-type: none"> • Wiring loose in inverter output terminal. • R/ L1, S/L2 or T/ L3 terminal screw loose or lost. • Motor rated current is less than 10% of the inverter rated current. 	<ul style="list-style-type: none"> • Check output wiring / faster screws. • Check motor & inverter rating.

LED display	Description	Cause	Possible solutions
OH1 Heatsink overheat	The temperature of the heat sink is too high. Note: when OH1 fault occurs three times within five minutes, it is required to wait 10 minutes before resetting the fault.	<ul style="list-style-type: none"> • Ambient temperature too high. • cooling fan failed • Carrier frequency set too high. • Cooling air duct block 	<ul style="list-style-type: none"> • Install fan or AC to cool surroundings. • Replace cooling fan. • Reduce carrier frequency.
OH1			
OL1 Motor overload	Internal motor overload protection tripped, active when protection curve 08-05 = xxx1.	<ul style="list-style-type: none"> • Voltage setting V/F mode too high, resulting in over-excitation of the motor. • Motor rated current (02-01) set incorrectly. • Load too heavy. 	<ul style="list-style-type: none"> • Check V/f curve. • Check motor rated current • Check and reduce motor load, check and operation duty cycle.
OL1			
OL2 Inverter overload	Inverter thermal overload protection tripped. If an inverter overload occurs 4 times in five minutes, it is required to wait 4 minutes before resetting the fault.	<ul style="list-style-type: none"> • Voltage setting V/F mode too high, resulting in over-excitation of the motor. • Inverter rating too small. • Load too heavy. 	<ul style="list-style-type: none"> • Check V/f curve. • Replace inverter with larger rating. • Check and reduce motor load, check and operation duty cycle.
OL2			
OT Over torque detection	Inverter output torque is higher than 08-15 (over torque detection level) for the time specified in 08-16. Parameter 08-14 = 0 to activate.	<ul style="list-style-type: none"> • Load too heavy. 	<ul style="list-style-type: none"> • Check over torque detection parameters (08-15 / 08-16). • Check and reduce motor load, check and operation duty cycle.
OT			
UT Under torque detection	Inverter output torque is lower than 08-19 (under torque detection level) for the time specified in 08-20. Parameter 08-18 = 0 to activate.	<ul style="list-style-type: none"> • Sudden drop in load. • Belt break. 	<ul style="list-style-type: none"> • Check under torque detection parameters (08-19 / 08-20). • Check load / application.
UT			
run Switch for Motor1/Motor 2	Switch for Motor1/Motor2 in running time	<ul style="list-style-type: none"> • Execute command for switching motor2 in running time • Execute command for switching motor in running time 	<ul style="list-style-type: none"> • Revise the sequence control and switch motor in stop time.
run			
CE communicati on error	No Modbus communication received in for the time specified in 09-06 (communication error detection time). Active when 09-07(= 0 to 2).	<ul style="list-style-type: none"> • Connection lost or wire broken. • Host stopped communicating. 	<ul style="list-style-type: none"> • Check connection • Check host computer / software.
CE			
FB PID feedback loss	PID feedback signal falls below level specified in 10-12 (PID feedback loss detection level) for the time specified in 10-13 (Feedback loss detection time). Active when parameter (10-11 = 2).	<ul style="list-style-type: none"> • Feedback signal wire broken • Feedback sensor broken. 	<ul style="list-style-type: none"> • Check feedback wiring • Replace feedback sensor.
Fb			

LED display	Description	Cause	Possible solutions
SS1 Digital input Stop command 	Digital input Stop command enabled	<ul style="list-style-type: none"> 08-30 =0 and 03-00~03-05=58 	<ul style="list-style-type: none"> Check if 08-30 =0 and 03-00~03-05=58
EF0 External fault 0 	External fault (Modbus)	Modbus communication 0x2501 bit 2= "1"	<ul style="list-style-type: none"> Reset Modbus communication 0x2501 bit 2= "1"
EF1 External fault (S1) 	External fault (Terminal S1) Active when 03-00= 25, and Inverter external fault selection 08-24=0 or 1.	<ul style="list-style-type: none"> Multifunction digital input external fault active. 	<ul style="list-style-type: none"> Multi-function input function set incorrectly. Check wiring
EF2 External fault (S2) 	External fault (Terminal S2) Active when 03-01= 25, and Inverter external fault selection 08-24=0 or 1.		
EF3 External fault (S3) 	External fault (Terminal S3) Active when 03-02= 25, and Inverter external fault selection 08-24=0 or 1.		
EF4 External fault (S4) 	External fault (Terminal S4) Active when 03-03= 25, and Inverter external fault selection 08-24=0 or 1.		
EF5 External fault (S5) 	External fault (Terminal S5) Active when 03-04= 25, and Inverter external fault selection 08-24=0 or 1.		
EF6 External fault (S6) 	External fault (Terminal S6) Active when 03-05= 25, and Inverter external fault selection 08-24=0 or 1.		

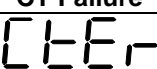
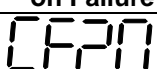
LED display	Description	Possible causes	Corrective action
CF07 Motor control fault 	Motor control fault	<ul style="list-style-type: none"> • SLV mode is unable to run motor. 	<ul style="list-style-type: none"> • Perform rotational or stationary auto-tune • Increase minimum output frequency (01-08)
FU fuse open 			
CF00 Operator Communication Error 	Errors of data transmission occur in keypad.	<ul style="list-style-type: none"> • keypad and inverter cannot transmit data after power on 5 seconds. 	<ul style="list-style-type: none"> • Disconnect the operator and then reconnect. • Replace the control board
CF01 Operator Communication Error 2 			
CTER CT Failure 	Errors of detecting voltages from three phase's current transformer to detect output current.	<ul style="list-style-type: none"> • Errors of detecting voltages • Noises too much • Control board failure 	<ul style="list-style-type: none"> • Check current transformer signal and the voltage on the control board.
CF20 Communication Failure 			

5.3 Warning / Self-diagnosis Detection Function

When the inverter detects a warning, the keypad displays a warning code (flash).

Note: The fault contact output does not energize on a warning and the inverter continues operation.

When the warning is no longer active the keypad will return to its original state.

















































When the inverter detected a programming error (for example two parameters contradict each other or are set to an invalid setting), the keypad displays a self-diagnostics code.







Note: The fault contact output does not energize on a self-diagnostics error. While a self-diagnostics code is active the inverter does not accept a run command until the programming error is corrected.







Note: When a warning or self-diagnostic error is active the warning or error code will flash on the keypad. When the RESET key is pressed, the warning message (flash) disappears and returns after 5 sec. If the warning or self-diagnostic error still exists.







Refer to Table 5.2 for an overview, cause and corrective action for inverter warnings and self-diagnostic errors.





Table 5.2 warning / self-diagnosis and corrective actions







LED display	Description	Possible causes	Corrective action																										
OV (flash) Over voltage 	DC bus voltage exceeds the OV detection level: 380V class: 820Vdc	<ul style="list-style-type: none"> The inverter input voltage is too high. 	<ul style="list-style-type: none"> Reduce input voltage to comply with the input voltage requirements or install an AC line reactor to lower the input voltage. 																										
				UV (flash) under voltage 	DC bus voltage is lower than the UV detection level or the pre-charge contactor is not active while the inverter is stopped. 380Vdc (the detection value can be adjusted by 07-13)	<ul style="list-style-type: none"> The input voltage is too low. Input phase loss. Input voltage fluctuation. Pre-charge contactor damaged. DC bus voltage feedback signal value not incorrect. 	<ul style="list-style-type: none"> Check the input voltage. Check input wiring. Check power source Replace pre-charge contactor Replace control board or complete inverter. 		OH1 Heatsink overheat 	The temperature of the heat sink is too high. Note: when OH1 fault occurs three times within five minutes, it is required to wait 10 minutes before resetting the fault.	<ul style="list-style-type: none"> Ambient temperature too high. cooling fan failed Carrier frequency set too high. Inverter damaged 	<ul style="list-style-type: none"> Install fan or AC to cool surroundings. Replace cooling fan. Reduce carrier frequency. Reduce load / Measure output current 		OH2 (flash) Inverter over heating warning 	Inverter overheat warning Multi-function digital input set to 31. (Terminal S1 ~ S6) Active when 03-00 ~ 03-05 = 31).	<ul style="list-style-type: none"> Multifunction digital input overheat warning active 	<ul style="list-style-type: none"> Multi-function input function set incorrectly. Check wiring 		OT (flash) over torque detection 	Inverter output torque is higher than 08-15 (over torque detection level) for the time specified in 08-16. Parameter 08-14 = 1 to activate.	<ul style="list-style-type: none"> Load too heavy. 	<ul style="list-style-type: none"> Check over torque detection parameters (08-15 / 08-16). Check and reduce motor load, check and operation duty cycle. 		UT (flash) under torque detection 	Inverter output torque is lower than 08-19 (under torque detection level) for the time specified in 08-20. Parameter 08-18 = 1 to activate.	<ul style="list-style-type: none"> Sudden drop in load. Belt break. 	<ul style="list-style-type: none"> Check under torque detection parameters (08-19 / 08-20). Check load / application. 		bb1 (flash) External baseblock 
UV (flash) under voltage 	DC bus voltage is lower than the UV detection level or the pre-charge contactor is not active while the inverter is stopped. 380Vdc (the detection value can be adjusted by 07-13)	<ul style="list-style-type: none"> The input voltage is too low. Input phase loss. Input voltage fluctuation. Pre-charge contactor damaged. DC bus voltage feedback signal value not incorrect. 	<ul style="list-style-type: none"> Check the input voltage. Check input wiring. Check power source Replace pre-charge contactor Replace control board or complete inverter. 																										
				OH1 Heatsink overheat 	The temperature of the heat sink is too high. Note: when OH1 fault occurs three times within five minutes, it is required to wait 10 minutes before resetting the fault.	<ul style="list-style-type: none"> Ambient temperature too high. cooling fan failed Carrier frequency set too high. Inverter damaged 	<ul style="list-style-type: none"> Install fan or AC to cool surroundings. Replace cooling fan. Reduce carrier frequency. Reduce load / Measure output current 		OH2 (flash) Inverter over heating warning 	Inverter overheat warning Multi-function digital input set to 31. (Terminal S1 ~ S6) Active when 03-00 ~ 03-05 = 31).	<ul style="list-style-type: none"> Multifunction digital input overheat warning active 	<ul style="list-style-type: none"> Multi-function input function set incorrectly. Check wiring 		OT (flash) over torque detection 	Inverter output torque is higher than 08-15 (over torque detection level) for the time specified in 08-16. Parameter 08-14 = 1 to activate.	<ul style="list-style-type: none"> Load too heavy. 	<ul style="list-style-type: none"> Check over torque detection parameters (08-15 / 08-16). Check and reduce motor load, check and operation duty cycle. 		UT (flash) under torque detection 	Inverter output torque is lower than 08-19 (under torque detection level) for the time specified in 08-20. Parameter 08-18 = 1 to activate.	<ul style="list-style-type: none"> Sudden drop in load. Belt break. 	<ul style="list-style-type: none"> Check under torque detection parameters (08-19 / 08-20). Check load / application. 		bb1 (flash) External baseblock 	External base block (Terminal S1)	<ul style="list-style-type: none"> Multifunction digital input external baseblock active. 	<ul style="list-style-type: none"> Multi-function input function set incorrectly. Check wiring 		
OH1 Heatsink overheat 	The temperature of the heat sink is too high. Note: when OH1 fault occurs three times within five minutes, it is required to wait 10 minutes before resetting the fault.	<ul style="list-style-type: none"> Ambient temperature too high. cooling fan failed Carrier frequency set too high. Inverter damaged 	<ul style="list-style-type: none"> Install fan or AC to cool surroundings. Replace cooling fan. Reduce carrier frequency. Reduce load / Measure output current 																										
				OH2 (flash) Inverter over heating warning 	Inverter overheat warning Multi-function digital input set to 31. (Terminal S1 ~ S6) Active when 03-00 ~ 03-05 = 31).	<ul style="list-style-type: none"> Multifunction digital input overheat warning active 	<ul style="list-style-type: none"> Multi-function input function set incorrectly. Check wiring 		OT (flash) over torque detection 	Inverter output torque is higher than 08-15 (over torque detection level) for the time specified in 08-16. Parameter 08-14 = 1 to activate.	<ul style="list-style-type: none"> Load too heavy. 	<ul style="list-style-type: none"> Check over torque detection parameters (08-15 / 08-16). Check and reduce motor load, check and operation duty cycle. 		UT (flash) under torque detection 	Inverter output torque is lower than 08-19 (under torque detection level) for the time specified in 08-20. Parameter 08-18 = 1 to activate.	<ul style="list-style-type: none"> Sudden drop in load. Belt break. 	<ul style="list-style-type: none"> Check under torque detection parameters (08-19 / 08-20). Check load / application. 		bb1 (flash) External baseblock 	External base block (Terminal S1)	<ul style="list-style-type: none"> Multifunction digital input external baseblock active. 	<ul style="list-style-type: none"> Multi-function input function set incorrectly. Check wiring 							
OH2 (flash) Inverter over heating warning 	Inverter overheat warning Multi-function digital input set to 31. (Terminal S1 ~ S6) Active when 03-00 ~ 03-05 = 31).	<ul style="list-style-type: none"> Multifunction digital input overheat warning active 	<ul style="list-style-type: none"> Multi-function input function set incorrectly. Check wiring 																										
				OT (flash) over torque detection 	Inverter output torque is higher than 08-15 (over torque detection level) for the time specified in 08-16. Parameter 08-14 = 1 to activate.	<ul style="list-style-type: none"> Load too heavy. 	<ul style="list-style-type: none"> Check over torque detection parameters (08-15 / 08-16). Check and reduce motor load, check and operation duty cycle. 		UT (flash) under torque detection 	Inverter output torque is lower than 08-19 (under torque detection level) for the time specified in 08-20. Parameter 08-18 = 1 to activate.	<ul style="list-style-type: none"> Sudden drop in load. Belt break. 	<ul style="list-style-type: none"> Check under torque detection parameters (08-19 / 08-20). Check load / application. 		bb1 (flash) External baseblock 	External base block (Terminal S1)	<ul style="list-style-type: none"> Multifunction digital input external baseblock active. 	<ul style="list-style-type: none"> Multi-function input function set incorrectly. Check wiring 												
OT (flash) over torque detection 	Inverter output torque is higher than 08-15 (over torque detection level) for the time specified in 08-16. Parameter 08-14 = 1 to activate.	<ul style="list-style-type: none"> Load too heavy. 	<ul style="list-style-type: none"> Check over torque detection parameters (08-15 / 08-16). Check and reduce motor load, check and operation duty cycle. 																										
				UT (flash) under torque detection 	Inverter output torque is lower than 08-19 (under torque detection level) for the time specified in 08-20. Parameter 08-18 = 1 to activate.	<ul style="list-style-type: none"> Sudden drop in load. Belt break. 	<ul style="list-style-type: none"> Check under torque detection parameters (08-19 / 08-20). Check load / application. 		bb1 (flash) External baseblock 	External base block (Terminal S1)	<ul style="list-style-type: none"> Multifunction digital input external baseblock active. 	<ul style="list-style-type: none"> Multi-function input function set incorrectly. Check wiring 																	
UT (flash) under torque detection 	Inverter output torque is lower than 08-19 (under torque detection level) for the time specified in 08-20. Parameter 08-18 = 1 to activate.	<ul style="list-style-type: none"> Sudden drop in load. Belt break. 	<ul style="list-style-type: none"> Check under torque detection parameters (08-19 / 08-20). Check load / application. 																										
				bb1 (flash) External baseblock 	External base block (Terminal S1)	<ul style="list-style-type: none"> Multifunction digital input external baseblock active. 	<ul style="list-style-type: none"> Multi-function input function set incorrectly. Check wiring 																						
bb1 (flash) External baseblock 	External base block (Terminal S1)	<ul style="list-style-type: none"> Multifunction digital input external baseblock active. 	<ul style="list-style-type: none"> Multi-function input function set incorrectly. Check wiring 																										









LED display	Description	Possible causes	Corrective action
			
bb2 (flash) External baseblock	External base block (Terminal S2)		
			
bb3 (flash) External baseblock	External base block (Terminal S3)		
			
bb4 (flash) External baseblock	External base block (Terminal S4)		
			
bb5 (flash) External baseblock	External base block (Terminal S5)		
			
bb6 (flash) External baseblock	External base block (Terminal S6)	<ul style="list-style-type: none"> • Multifunction digital input external baseblock active. 	<ul style="list-style-type: none"> • Multi-function input function set incorrectly. • Check wiring
			

LED display	Description	Possible causes	Corrective action
OL1 Motor overload 	Internal motor overload protection tripped, active when protection curve 08-05 = xxx1.	<ul style="list-style-type: none"> • Voltage setting V/F mode too high, resulting in over-excitation of the motor. • Motor rated current (02-01) set incorrectly. • Load too heavy. 	<ul style="list-style-type: none"> • Check V/f curve. • Check motor rated current • Check and reduce motor load, check and operation duty cycle.
OL2 Inverter overload 	Inverter thermal overload protection tripped. If an inverter overload occurs 4 times in five minutes, it is required to wait 4 minutes before resetting the fault.	<ul style="list-style-type: none"> • Voltage setting V/F mode too high, resulting in over-excitation of the motor. • Inverter rating too small. • Load too heavy. 	<ul style="list-style-type: none"> • Check V/f curve. • Replace inverter with larger rating. • Check and reduce motor load, check and operation duty cycle.
CE (flash) communication error 	No Modbus communication received for 2 sec. Active when 09-07=3.	<ul style="list-style-type: none"> • Connection lost or wire broken. • Host stopped communicating. 	<ul style="list-style-type: none"> • Check connection • Check host computer / software.
CLA over current protection level A 	Inverter current reaches the current protection level A.	<ul style="list-style-type: none"> • Inverter current too high. • Load too heavy. 	<ul style="list-style-type: none"> • Check load and duty cycle operation.
CLB over current protection level B 	Inverter current reaches the current protection level B.	<ul style="list-style-type: none"> • Inverter current too high. • Load too heavy. 	<ul style="list-style-type: none"> • Check load and duty cycle operation.
Retry (flash) retry 	Automatic reset activated, warning is displayed until restart delay time set (07-01) expires.	<ul style="list-style-type: none"> • Parameter 07-01 set to a value greater than 0. • Parameter 07-02 set to a value greater than 0. 	<ul style="list-style-type: none"> • Warning disappears after automatic reset.
ES (flash) External emergency stop 	External emergency stop Enabled.	<ul style="list-style-type: none"> • 03-00~03-05 set to 14, and the digital input enabled. 	<ul style="list-style-type: none"> • Turn off run command, and remove external emergency stop command.

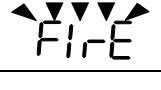
LED display	Description	Possible causes	Corrective action
EF1 (flash) External fault (S1) 	External fault (Terminal S1) Active when 03-00=25, and Inverter external fault selection 08-24=2.	<ul style="list-style-type: none"> • Multifunction digital input external fault active and parameter 08-24 = 2 for operation to continue. 	<ul style="list-style-type: none"> • Multi-function input function set incorrectly. • Check wiring
EF2 (flash) External fault (S2) 	External fault (Terminal S2) Active when 03-01=25, and Inverter external fault selection 08-24=2.		
EF3 (flash) External fault (S3) 	External fault (Terminal S3) Active when 03-02=25, and Inverter external fault selection 08-24=2.		
EF4 (flash) External fault (S4) 	External fault (Terminal S4) Active when 03-03=25, and Inverter external fault selection 08-24=2.		
EF5 (flash) External fault (S5) 	External fault (Terminal S5) Active when 03-04=25, and Inverter external fault selection 08-24=2.		
EF6 (flash) External fault (S6) 	External fault (Terminal S6) Active when 03-05=25, and Inverter external fault selection 08-24=2.		

LED display	Description	Possible causes	Corrective action
EF9 (flash) error of forward/revers al rotation 	Forward run and reverse run are active within 0.5 sec of each other. Stop method set by parameter 07-09.	<ul style="list-style-type: none"> • Forward run and reverse run active (see 2-wire control). 	<ul style="list-style-type: none"> • Check run command wiring
SE01 Rang setting error 	Parameter setting falls outside the allowed range.	<ul style="list-style-type: none"> • Some parameter ranges are determined by other inverter parameters which could cause an out of range warning when the dependency parameter is adjusted. Example: 1.02-00>02-01, or 02-20 >02-21 2.00-12>00-13, 3.00-07 = 1,00-05=00-06 4.02-03 > 02-06 or 02-22 > 02-25 5.20-16 < 20-15 	<ul style="list-style-type: none"> • Check parameter setting.
SE02 Digital input terminal error 	Multi-function input setting error.	<ul style="list-style-type: none"> • Multi-function digital input terminals (03-00 to 03-05) are set to the same function (not including ext. fault and not used.) or ①UP/DOWN commands are not set at the same time(they must be used together). ②UP/DOWN commands (08 and 09) and ACC/DEC commands (11) are set at the same time. ③Speed search 1(19, maximum frequency) and Speed search 2 (34, from the set frequency) are set at the same time. 03-00~03-05 set two-wire and three-wire in the same time. 	<ul style="list-style-type: none"> • Check multi-function input setting.
SE03 V/f curve error 	V/f curve setting error.	<ul style="list-style-type: none"> • V/F curve setting error. ① 01-02 > 01-12 > 01-06 >01-08; • (Fmax) (Fbase) (Fmid1) (Fmin) ②01-16 > 01-24 > 01-20 > 01-22; • (Fmax2) (Fbase2)(Fmid1) (Fmin2) 	<ul style="list-style-type: none"> • Check V/F parameters
SE05 PID selection error 	PID selection error.	<ul style="list-style-type: none"> • 10-00 and 10-01 set to 1(AI1) or set to 2(AI2) • 10-29 = 1 or 2 and 10-25 = 1 allow to reverse. • 10-29 = 1 or 2 and 10-03 =1xxxb(PID output+ target value) 	<ul style="list-style-type: none"> • Check 10-00 and 10-01 • Check 10-29 and 10-25 • Check 10-29 and 10-03

LED display	Description	Possible causes	Corrective action
HPErr Model selection error 	Inverter capacity setting error: Inverter capacity setting 13-00 does not match the rated voltage.	<ul style="list-style-type: none"> Inverter capacity setting does not match voltage class (13-00). 	<ul style="list-style-type: none"> Check inverter capacity setting 13-00.
SE09 PI setting error 	Inverter PI setting error	<ul style="list-style-type: none"> Inverter pulse input selection (03-30) selection conflicts with PID source (10-00 and 10-01). 	<ul style="list-style-type: none"> Check pulse input selection (03-30) and PID source (10-00 and 10-01).
FB (flash) PID feedback breaking 	PID feedback signal falls below level specified in 10-12 (PID feedback loss detection level) for the time specified in 10-13 (Feedback loss detection time). Active when parameter (10-11 = 1).	<ul style="list-style-type: none"> Feedback signal wire broken Feedback sensor broken. 	<ul style="list-style-type: none"> Check feedback wiring Replace feedback sensor.
USP (flash) Unattended Start Protection 	Unattended Start Protection (USP) is enabled (enabled at power-up.)	<ul style="list-style-type: none"> USP at power-up (activated by multi-function digital input) is enabled. The inverter will not accept a run command. While the warning is active the inverter does not accept a run command. (See parameter 03-00 - 03-05 = 50). 	<ul style="list-style-type: none"> Remove run command or reset inverter via multi-function digital input (03-00 to 03-05 = 17) or use the RESET key on the keypad to reset inverter. Activate USP input and re-apply the power.
STP0 Zero Speed Stop Error 	Frequency command is smaller than 01-08 without DC brake.	<ul style="list-style-type: none"> Frequency command is smaller than motor minimum output frequency. 	<ul style="list-style-type: none"> Adjust frequency command
STP2 External Terminal Stop Error 	External Terminal is main run command source selection (00-02=1) and run command executes but executes stop command from keypad.	<ul style="list-style-type: none"> Run command executes from external terminal but executes stop command from keypad. 	<ul style="list-style-type: none"> Remove the run command from external terminal
RunEr Wrong running direction Error	Running direction is different from 11-00	<ul style="list-style-type: none"> Check the command among 11-00, jog and DI control to see if any difference. 	<ul style="list-style-type: none"> Revise the command among 11-00, jog and DI control to see if any difference

LED display	Description	Possible causes	Corrective action
			
PArEr Parameter setting error 	Parameter setting error	<ul style="list-style-type: none"> The parameter setting is wrong 	<ul style="list-style-type: none"> Please refer to the manual for correct setting
STP1 Direct start warning 	The inverter can't start directly, due to 07-04=1	<ul style="list-style-type: none"> Run command from the terminal is enabled and 07-04=1 	<ul style="list-style-type: none"> Remove the run command from the terminal first, and enabled later.
FirE Fire mode enabled 	Fire mode enabled	<ul style="list-style-type: none"> Fire mode enabled. 	<ul style="list-style-type: none"> Check the environment and confirm the fire status. If no fire, turn off the power and power on again.
AdCEr Voltage on C/B error 	The voltage on the control board error	<ul style="list-style-type: none"> Errors of detecting voltages Noises too much Control board failure 	<ul style="list-style-type: none"> Check the voltage on the control board.
EPerr EEPROM Save error 	The data save in EEPROM is wrong.	<ul style="list-style-type: none"> EEPROM circuit failure Parameter check error after power on 	<ul style="list-style-type: none"> Restore factory setting, then cut off the power and power on again. If warning again, replace control board.
bdErr Control board error 	Firmware can't meet Control board.	<ul style="list-style-type: none"> Firmware can't meet Control board. 	<ul style="list-style-type: none"> Replace the control board.
Parameter Lock 	Parameter lock key code (password) already locked	<ul style="list-style-type: none"> Parameter lock key code already enable (13-07) 	<ul style="list-style-type: none"> Lifting the parameter lock key code, to enter the correct parameter for 13-07
Set password failed 	Parameter lock key code cannot enable	<ul style="list-style-type: none"> To enable the parameter lock key code (password) function, but the password is not correct 	<ul style="list-style-type: none"> Enter the correct parameter for 13-07 to enable the parameter lock key

5.4 Auto-tuning Error

When a fault occurs during auto-tuning of a standard AC motor, the display will show the “AtErr” fault and the motor stops. The fault information is displayed in parameter 17-11.

Note: The fault contact output does not energize with an auto-tuning fault. Refer to Table 5.3, for fault information during tuning, cause and corrective action.

Table 5.3 Auto-tuning fault and corrective actions

Error	Description	Cause	Corrective action
01	Motor data input error.	<ul style="list-style-type: none"> Motor Input data error during auto-tuning. Inverter output current does not match motor rated current. 	<ul style="list-style-type: none"> Check the motor tuning data (17-00 to 17-09). Check inverter capacity
02	Motor lead to lead resistance R1 tuning error.	<ul style="list-style-type: none"> Auto-tuning is not completed within the specified time Auto-tuning results fall outside parameter setting range. Motor rated current exceeded. Motor was disconnected. 	<ul style="list-style-type: none"> Check the motor tuning data (17-00 to 17-09). Check motor connection. Disconnect motor load. Check inverter current detection circuit and DCCTs. Check motor installation.
03	Motor leakage inductance tuning error.		
04	Motor rotor resistance R2 tuning error.		
05	Motor mutual inductance Lm tuning error.		
07	Deadtime compensation detection error		
08	Motor acceleration error (Rotational type auto-tuning only).	<ul style="list-style-type: none"> Motor fails to accelerate in the specified time (00-14=20sec). 	<ul style="list-style-type: none"> Increase acceleration time (00-14). Disconnect motor load.
09	Other	<ul style="list-style-type: none"> No load current is higher than 70% of the motor rated current. Torque reference exceeds 100%. Errors other than ATE01~ATE08. 	<ul style="list-style-type: none"> Check the motor tuning data (17-00 to 17-09). Check motor connection.

Chapter 6 Inverter Peripheral devices and Options

6.1 Braking Resistors and Braking Units

Inverters ratings T310 380V15~30HP have a built-in braking transistor. For applications requiring a greater braking torque an external braking resistor can be connected to terminals P1 and BR; for inverter ratings 380V 40-215HP, an external braking unit connected to ⊕ - ⊖ of the inverter is required.

Table 6.1 List of braking resistors and braking units

Inverter			Braking unit		Braking resistor				Braking torque (Peak / Continues) 10%ED	Minimum Resistance*	
Input Voltage	HP	KW	Model	Qty Req.	Part Number	Resistor specification	Spec for one Resistor (W/Ω)	ty Req. (PCS)		(Ω)	(W)
380V 3 Ø	15	11	-	-	1600W/50Ω	1	1600W/50Ω	1	126%	43	1600
	20	15	-	-	1500W/40Ω	1	1500W/40Ω	1	119%	22	3000
	25	18.5	-	-	4800W/32Ω	1	1200W/32Ω	4	119%	14	4800
	30	22	-	-	4800W/27.2Ω	1	1200W/27.2Ω	4	117%	14	4800
	40	30	JNTBU-430	2	6000W/20Ω	1	1500W/20Ω	4	119%	11	6000
	50	37	JNTBU-430	2	4800W/32Ω	2	1200W/32Ω	8	119%	19.2	3600
	60	45	JNTBU-430	2	4800W/27.2Ω	2	1200W/27.2Ω	8	117%	19.2	3600
	75	55	JNTBU-430	2	6000W/20Ω	2	1500W/20Ω	8	126%	19.2	3600
	100	150/165	JNTBU-430	3	6000W/20Ω	3		12	139%	19.2Ω	
	125	180/208	JNTBU-430	3	6000W/20Ω	3		12	115%	19.2Ω	
	150	216/250	JNTBU-430	4	6000W/20Ω	4		16	125%	19.2Ω	
	175	260/296	JNTBU-430	4	6000W/20Ω	4		16	111%	19.2Ω	
	215	295/328	JNTBU-430	5	6000W/20Ω	5		16	112%	19.2Ω	

*1: Minimum resistance is the acceptable minimum value of the braking resistor for a single braking unit.

- Note:** 1) Keep sufficient space between inverter, braking unit and braking resistor and ensure proper cooling is provided for.
 2) The braking resistor is for reference only, and the specific selection is based on on-site load situation.

6.2 AC Line Reactors

An AC line reactor can be used for any of the following:

- Capacity of power system is much larger than the inverter rating.
- Inverter mounted close to the power system (in 33ft / 10 meters).
- Reduce harmonic contribution (improve power factor) back to the power line.
- Protect inverter input diode front-end by reducing short-circuit current.
- Minimize overvoltage trips due to voltage transients.

Please select the AC line reactor based on the inverter rating according to the following table.

Table 6.2(1) List of AC Line Reactors

Input Voltage	Model		AC reactor	
	HP	Rated Current(A) HD	Specification (mH / A)	Rated Current(A)
380V 3 Ø	15	24	0.65	40
	20	31	0.53	50
	25	39	0.46	55
	30	45	0.35	70
	40	60	0.28	90
	50	75	0.23	110
	60	91	0.2	130
	75	118	0.14	180
	100	150	0.11	200
	125	180	0.09	250
	150	216	0.06	330
	175	260	0.06	330
215	304	0.05	400	

Note: AC reactors listed in this table can only be used for the inverter input side. Do not connect AC reactor to the inverter output side. 380V class 40HP~215HP have a built-in DC reactors. If required by the application an AC reactor may be added.

380V 15HP-30HP: reserve external DCL terminal between ⊕-P1.

Suggestions for external DCL

- According to below descriptions, please select or change DCL.

Table 6.2(2) DCL Lists

Inverter Model			DCL	
V	HP	Rated current (A)	Inductance (mH)	Rated current (A)
380V 3 Ø	15	24	0.65	36
	20	31	0.53	47
	25	39	0.46	59
	30	45	0.35	68
	40	60	0.3	120
	50	75	0.3	120
	60	91	0.29	190
	75	118	0.18	240

Note:

1) 15HP-30HP: reserved external DCL terminal between ⊕-P1. Please refer to external specifications on the above table.

2) 40-215HP: standard built-in DCL. Please refer to the actual built-in specifications on the above table.

6.3 Input Noise Filters

A. Input Noise Filter on Specifications & Ratings

Install a noise filter on power supply side to eliminate noise transmitted between the power line and the inverter. The inverter noise filter shown in Table 6.3 below meets the EN61800-3 class A specification. 380V inverter class models can be ordered with integrated noise filter.

Table 6.3 Input Noise Filter Specifications and Ratings

Inverter size		Noise filter			
Input voltage	HP	Model	Manufacturer	Data	Dimension (mm)
380V 3Ø	15HP/20HP	LCR 097.08004.00	LCR	3 Ø.480V,50/60Hz,80A	340*125*100
	25HP/30HP/40HP/50 HP	LCR 097.08004.00	LCR	3 Ø.480V,50/60Hz,80A	340*125*100
	60HP~215 HP	FS32126-361-99	SCHaffner	3 Ø.520/300V,50/60Hz,361 A	320*225*85

Note: only the noise filter on the above table is selected, can the corresponding EMC level be reached.

6.4 Input Current and Fuse Specifications

380V class

Model	Horse power	KVA	rated output current (A)	Rated input current (A)	Fuse rating (A)
T310-4015-H3C	15	18.3	24	35	63
T310-4020-H3C	20	23.6	31	45	80
T310-4025-H3C	25	29.7	39	56	100
T310-4030-H3C	30	34.3	45	65	120
T310-4040-H3C	40	45.7	60	87	150
T310-4050-H3C	50	57.2	75	109	200
T310-4060-H3C	60	69.3	91	132	250
T310-4075-H3C	75	89.9	118	171	300
T310-4100-H3C	100	114	150	159	250
T310-4125-H3C	125	137	180	181	300
T310-4150-H3C	150	165	216	229	350
T310-4175-H3C	175	198	260	275	400
T310-4215-H3C	215	225	304	325	450

Fuse type: Choose semiconductor fuse to comply with UL.

Class: CC, J, T, RK1 or RK5

Voltage Range:

For 380V class inverter, use 500V class fuse.

6.5 Other Options

A. Blank cover and keypad extension cable

When used for remote control purposes, the keypad can be removed and remotely connected with an extension cable. Extension cables are available in the following lengths: 1m, 2m, 3m, and 5m.

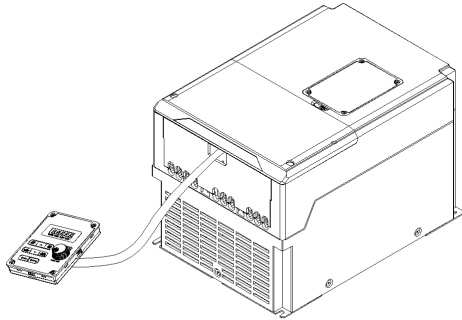

Remote control

Name	Model	Specification
LED digital operator wire	JN5-CB-01M	1m
	JN5-CB-02M	2m
	JN5-CB-03M	3m
	JN5-CB-05M	5m

When using a remote mount keypad a blank cover can be installed in place of the original keypad to prevent dust and debris from entering the inverter.

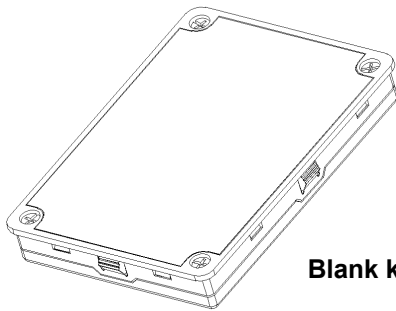

Blank keypad cover

Name	Model	Specification
Blank cover	JN3-OP-T02	Blank cover

LED keypad dimensions

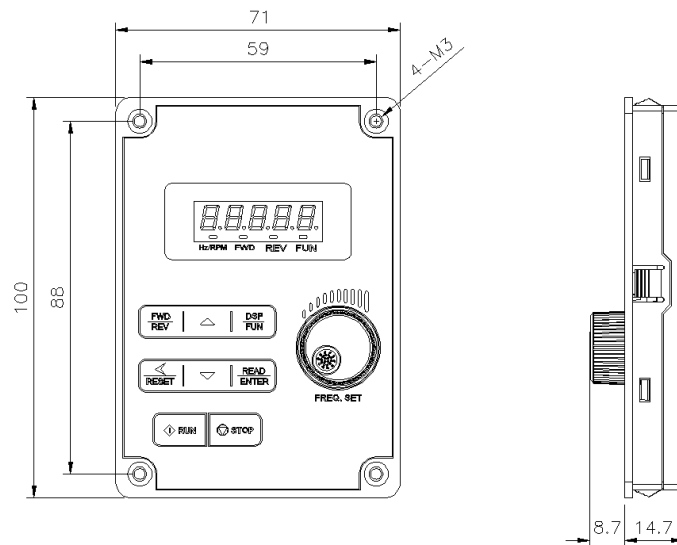

LED digital controller installation dimensions - 1

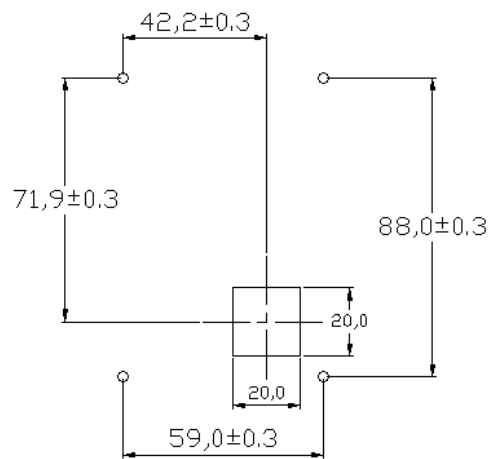
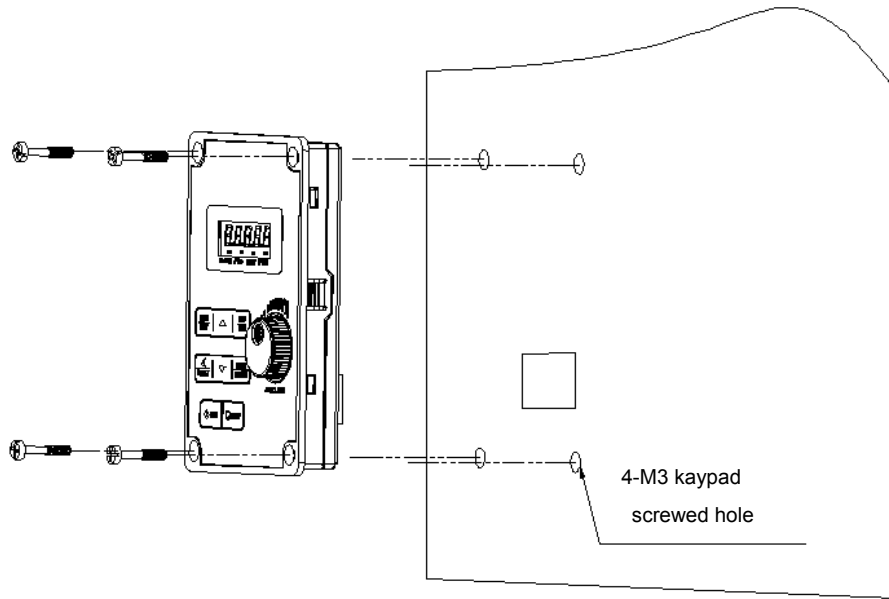

LED digital controller installation dimensions - 2

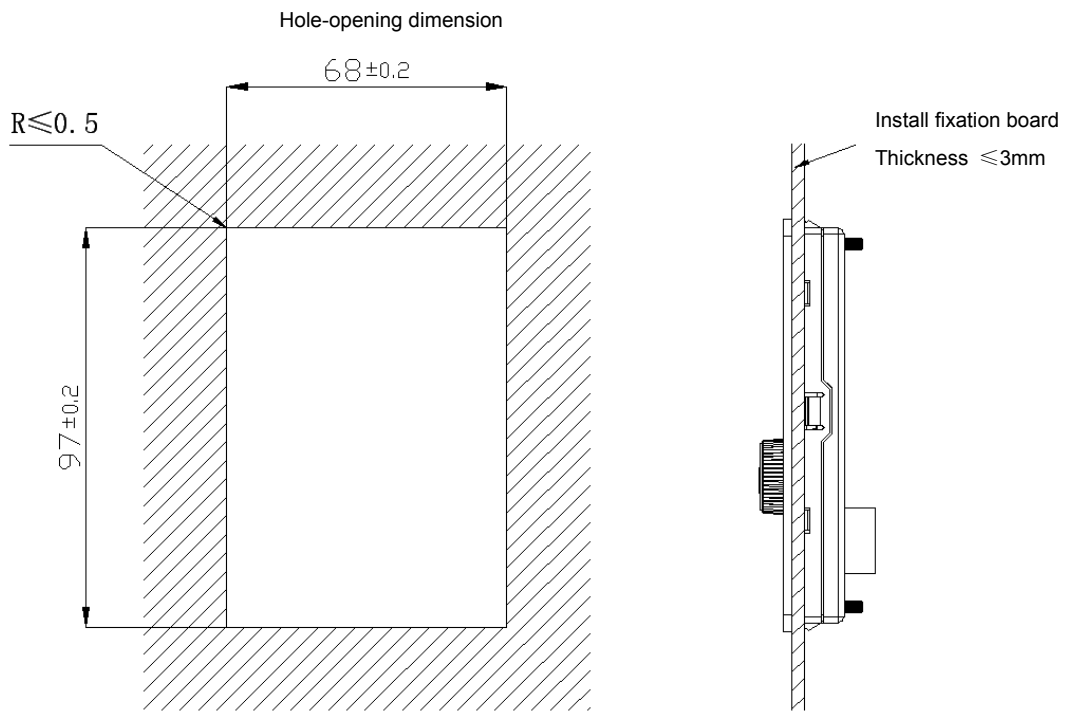

B. Copy Unit (JN5-CU)

The copy unit is used to copy an inverter parameter setup to another inverter. The copy unit saves time in applications with multiple inverters requiring the same parameter setup.

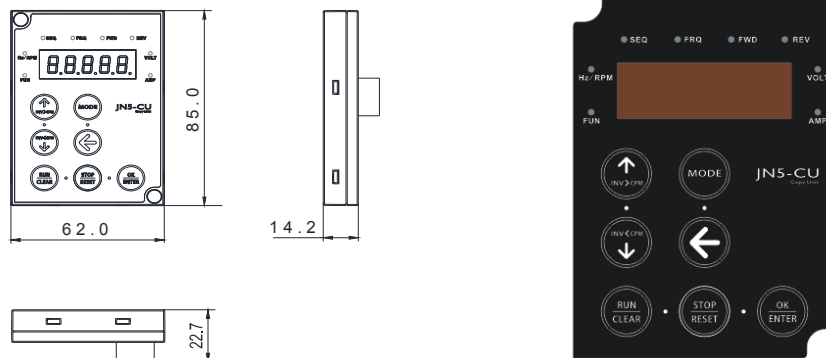

Copy Unit (JN5-CU) dimensions and appearance

6.6 Communication Options

(a) PROFIBUS communication interface module (JN5-CM-PDP)

For wiring example and communication setup refer to JN5-CM-PDP communication option manual.

(b) DEVICENET communication interface module (JN5-CM-DNET)

For wiring example and communication setup refer to JN5-CM-DNET communication option manual.

(c) CANopen communication interface module (JN5-CM-CAN)

For wiring example and communication setup refer to JN5-CM-CAN communication option manual.

Appendix A: Communication Networks

A1.1 RS485 –Network (Modbus)

This section shows a RS485 network consisting of several inverters communicating using the built-in Modbus RTU protocol.

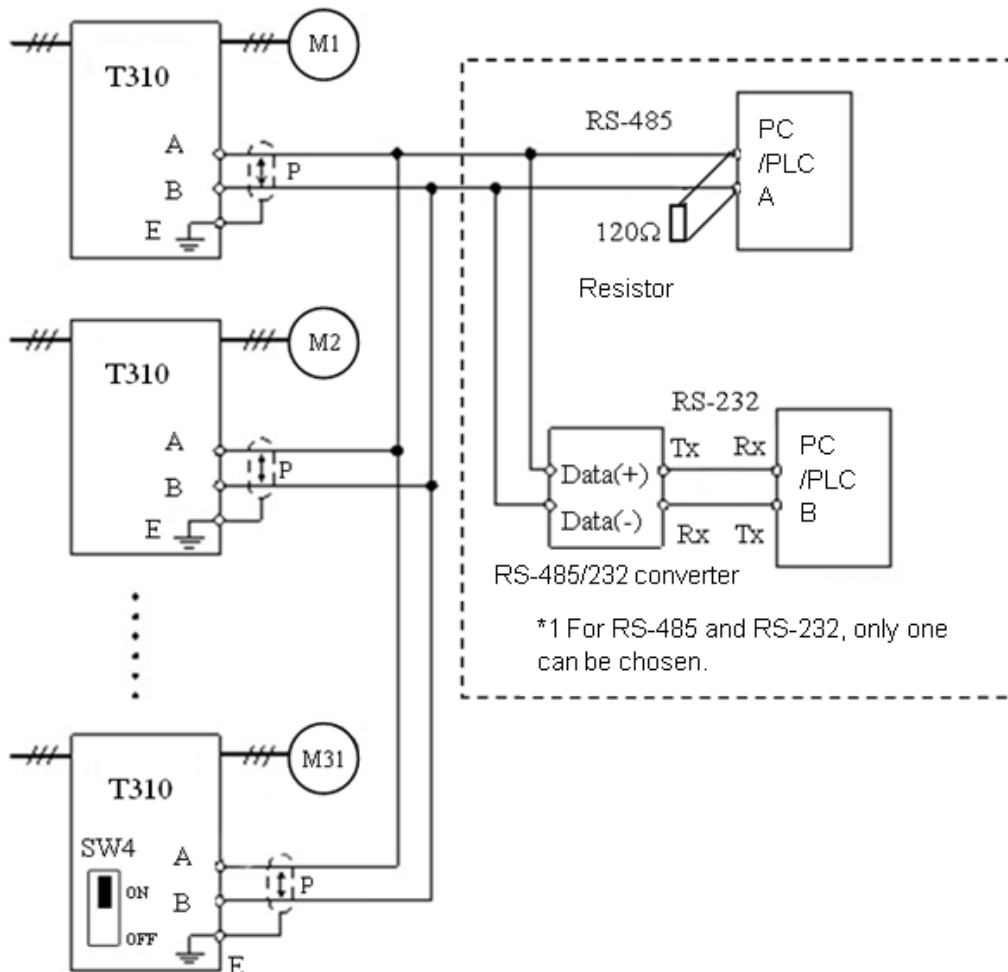

Wiring diagram RS485 Modbus RTU Network

Notes:

- A PC / PLC controller with a built-in RS-485 interface can be connected directly to the RS-485 network. Use a RS232 to RS485 converter to connect a PC / PLC with a built-in RS-232 interface.
- A maximum of 31 inverters can be connected to the network. Terminating resistors of 120 ohm must be installed at both end of the network.

Refer to T310 RS-485 Modbus communication manual for more information.

A1.2 Profibus DP Network

This section shows a Profibus DP network consisting of several inverters communicating using the profibus DB option card.

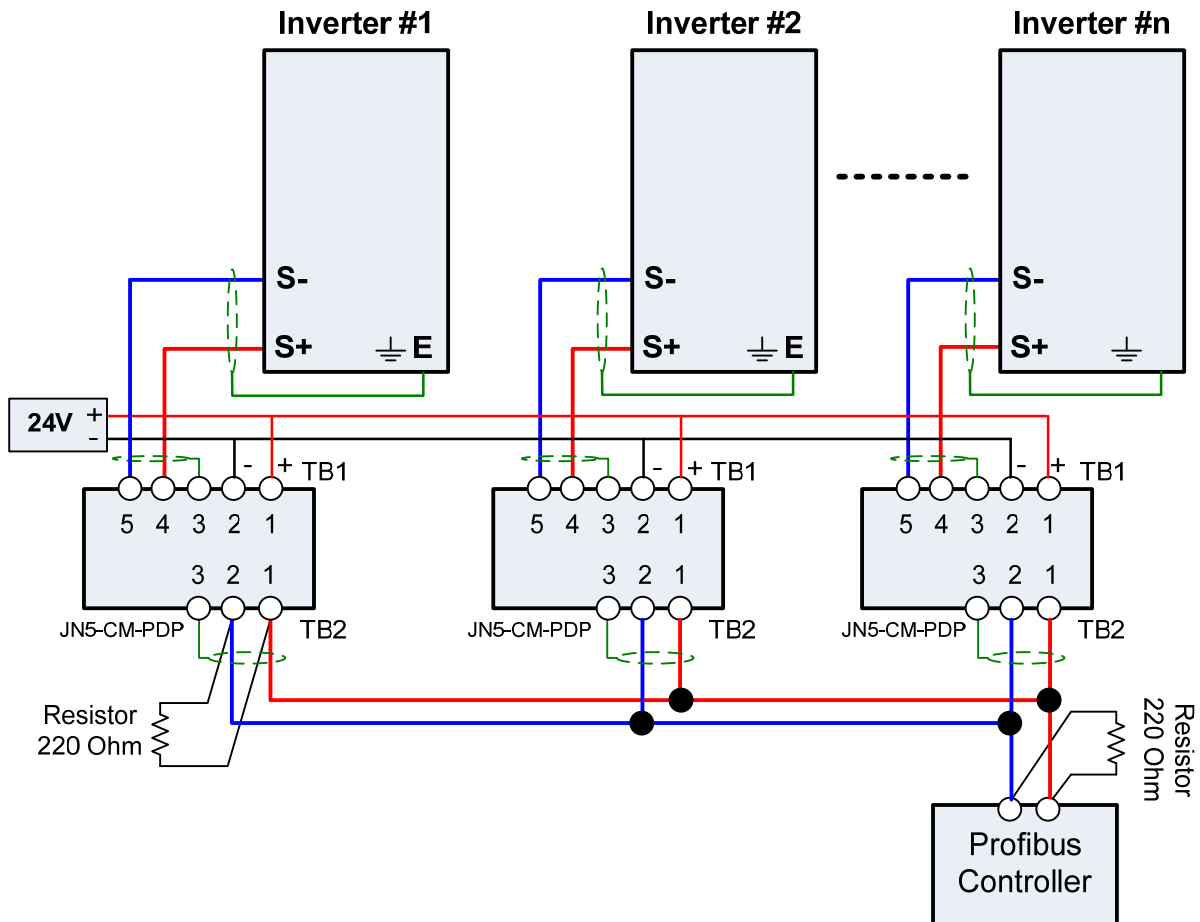

Wiring diagram Profibus DP Network

Notes:

- Requires a Profibus DP option card (JN5-CM-PDP) for each inverter.
- Requires 24Vdc power supply. Size power supply based on the number of inverters on the network.
- A maximum of 31 inverters can be connected to the network. Terminating resistors of 220 ohm must be installed at both end of the network.

Refer to JN5-CM-PDP option communication manual for more information.

B. SINK/SOURCE Terminal Interface Wiring

- T310 terminals S1~S6 set SINK or SOURCE interface.
 - a. SINK interface wiring: SW3 pin is set to SINK position.
 - b. Use NPN-type (SINK) detector as standard wiring of operation signal:

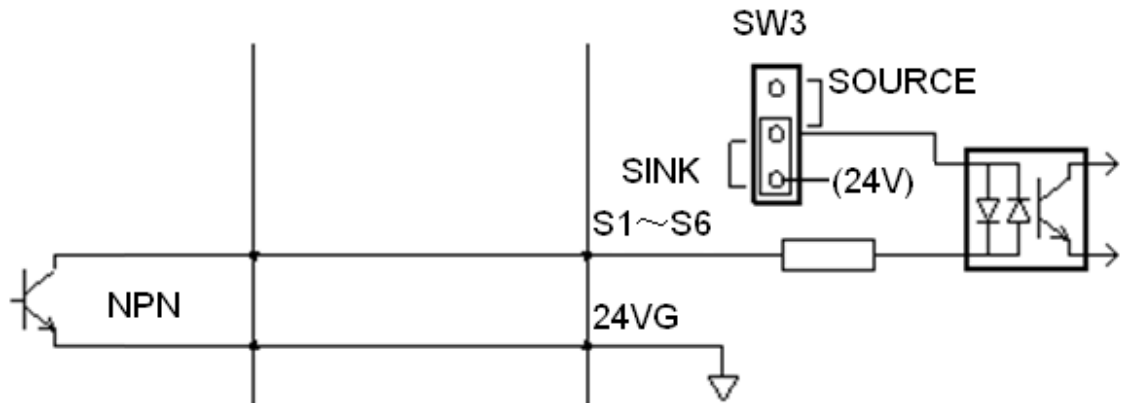

- c. SOURCE interface wiring: SW3 pin is set to SOURCE position.
 - Use PNP-type (SOURCE) detector as standard wiring of operation signal:

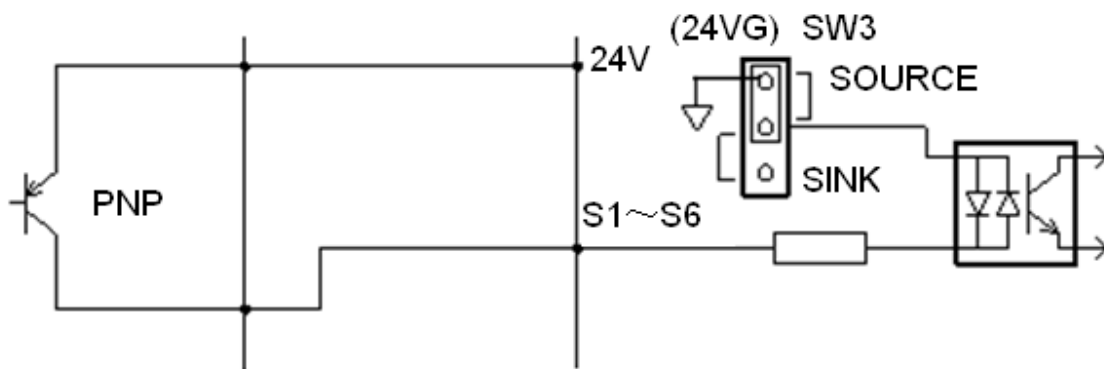

Appendix B

Name and content of hazardous substances in products

Part Name	Toxic or Hazardous Substances or Elements					
	Pb	Hg	Cd	Cr(VI)	PBB	PBDE
Electronic Parts	X	X	X	O	O	O
Display	O	O	O	O	O	O
Wire and Cable	X	O	O	O	O	O
Mechanical Parts	X	O	O	O	O	O

O: Indicates that this toxic or hazardous substance contained in all of the homogeneous materials for this part is below the limit requirement in GB/T 26572.

X: Indicates that this toxic or hazardous substance contained in at least one of the homogeneous materials for this part is above the limit requirement in GB/T 26572.

Definition of Major Subassembly used for Part Name:

Electronic Parts - may include electronic components, printed circuit board with solder.

Display - may include display unit, electronics, touch panel.

Wire and Cable - may include termination, wiring, shielding, sheath, electronic components.

Mechanical Parts - all items except Electronic Parts, Display, Wire and Cable as defined in the other Major Subassemblies.

Disclaimer: Information provided by **TAIAN TECHNOLOGY (WUXI) CO, LTD.**, concerning the substance content of its products represents **TAIAN TECHNOLOGY (WUXI) CO, LTD.**'s knowledge and belief as of the date that it is provided. **TAIAN TECHNOLOGY (WUXI) CO, LTD.** bases its knowledge and belief on information provided by the third parties and makes no representation or warranty as to the accuracy of such information as provided by the third parties. **TAIAN TECHNOLOGY (WUXI) CO, LTD.** may not have conducted destructive testing or chemical analysis on incoming materials and chemicals. The use of the above product and **TAIAN TECHNOLOGY (WUXI) CO, LTD.**'s liability, if any, shall be governed by **TAIAN TECHNOLOGY (WUXI) CO, LTD.**'s standard Terms and Conditions.

Appendix C

T310 F3 EMI Configuration 1

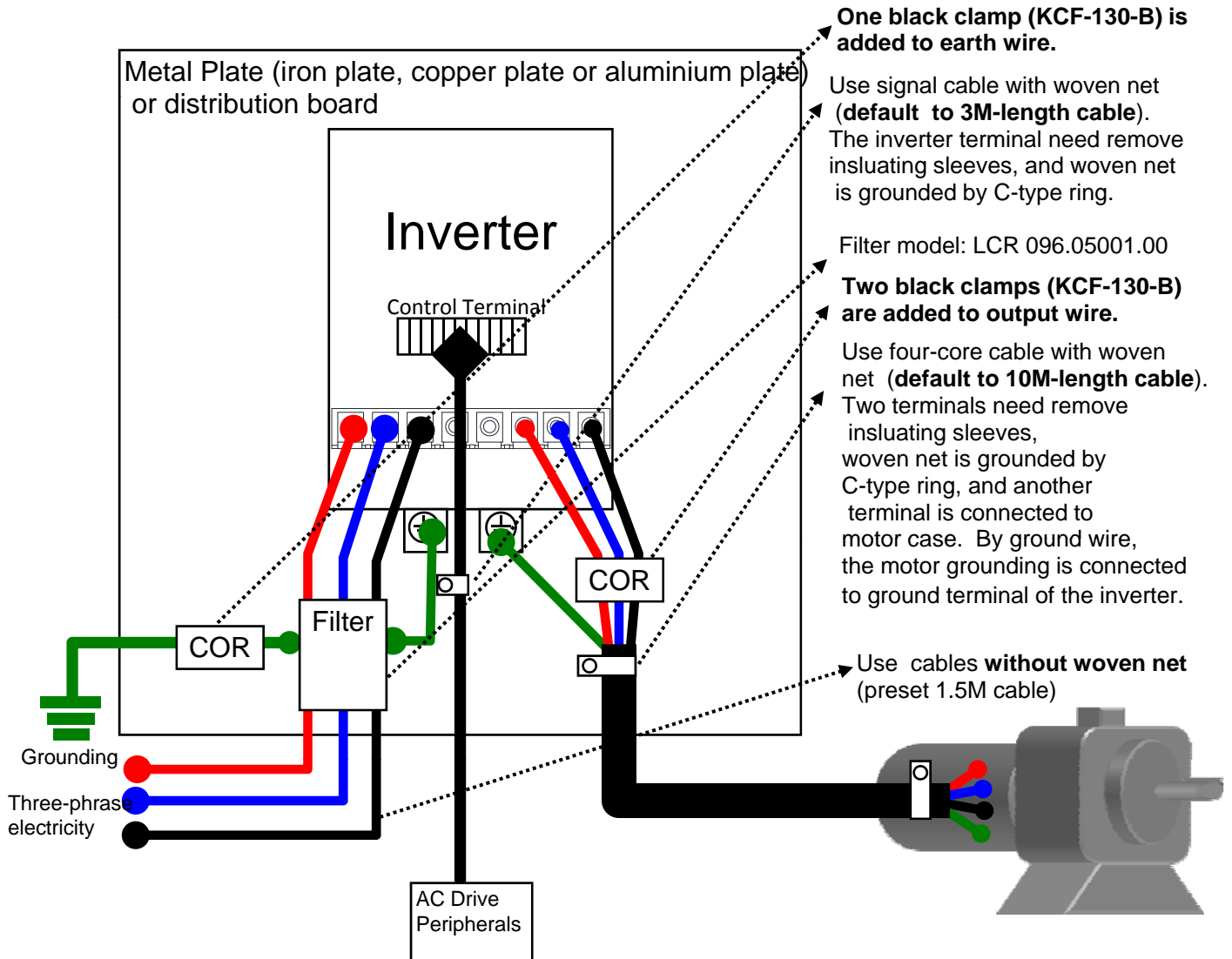

C-1

T310 F4 EMI Configuration 1

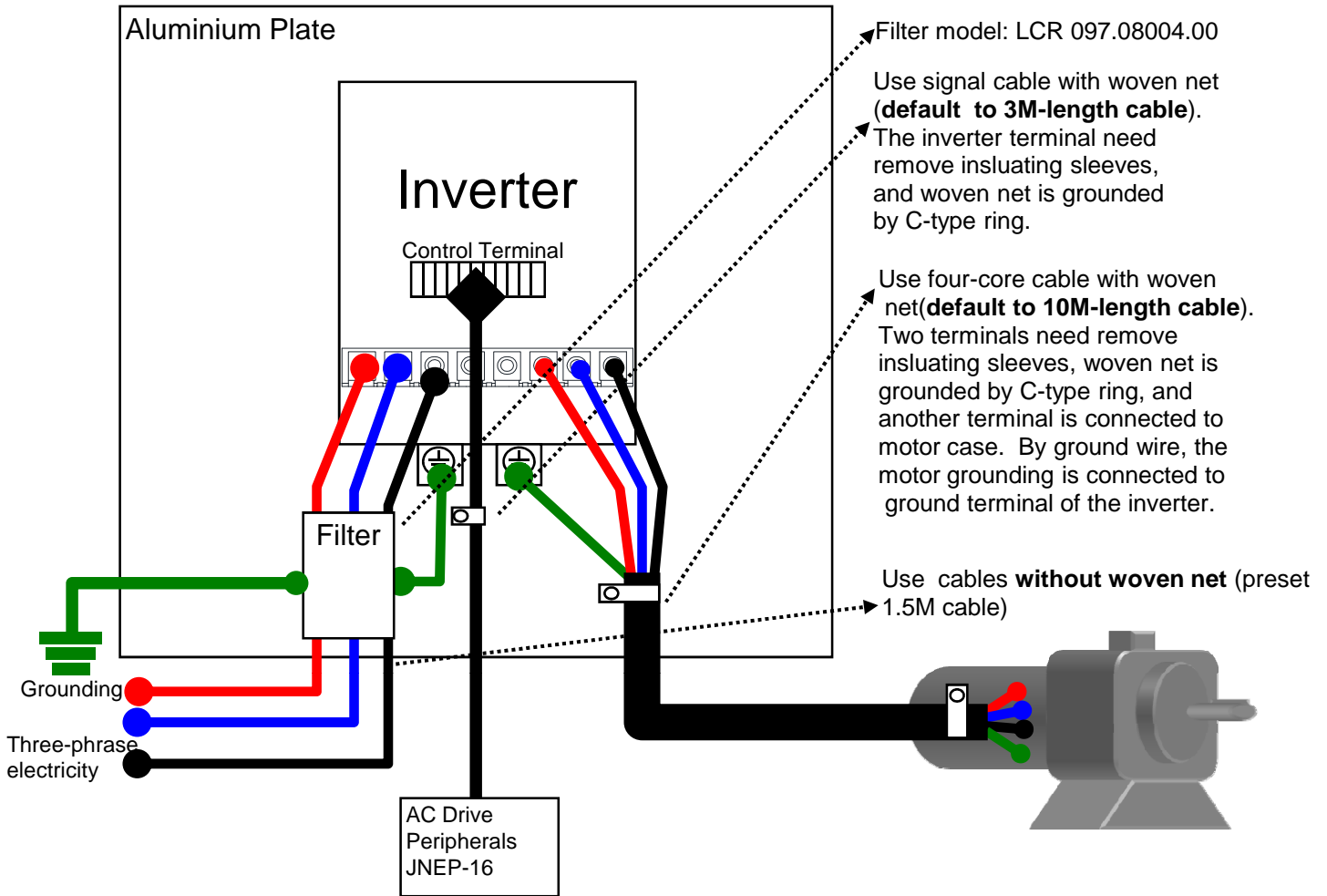

T310 F5 EMI Configuration 1

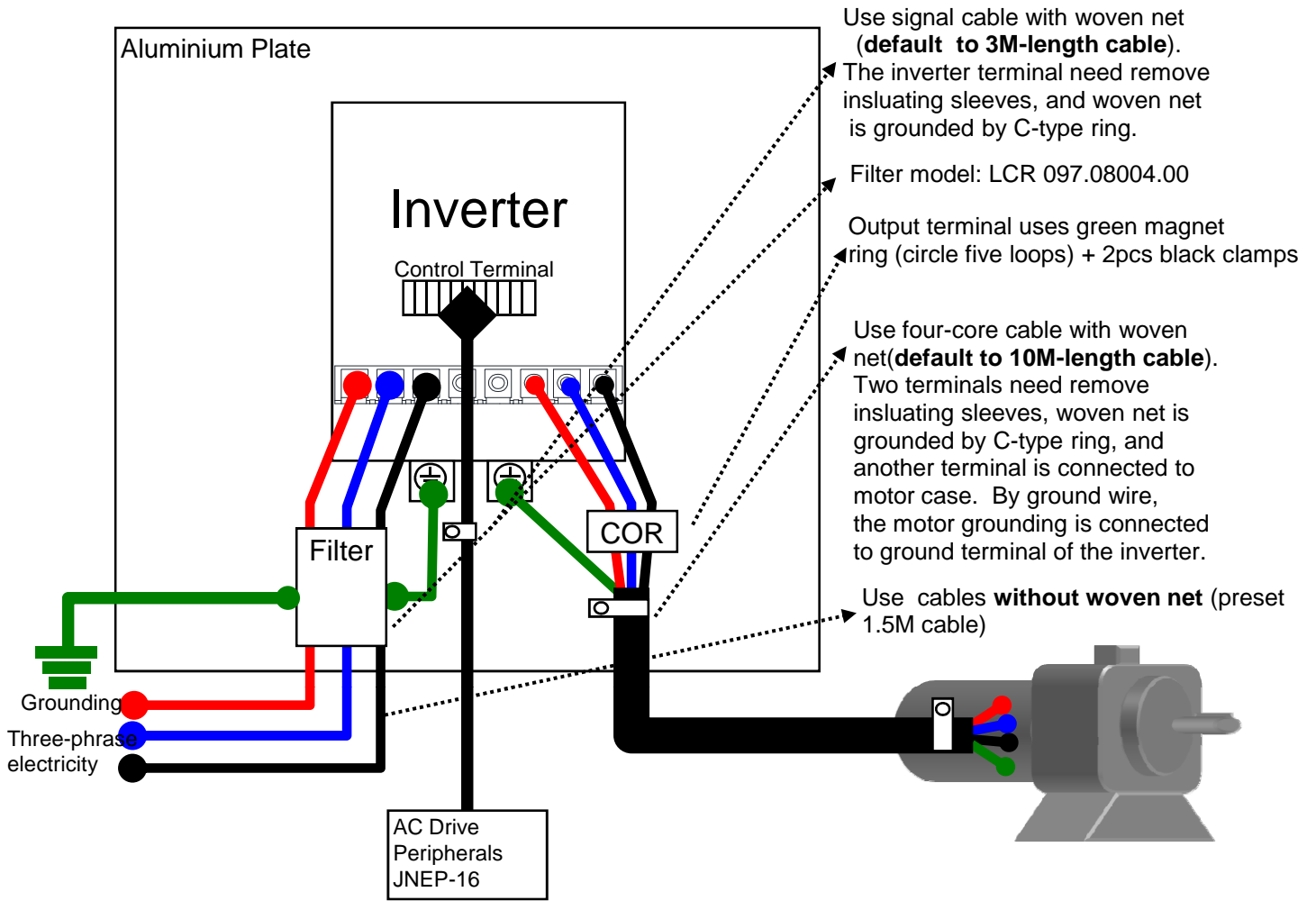

T310 F6 EMI Configuration 1

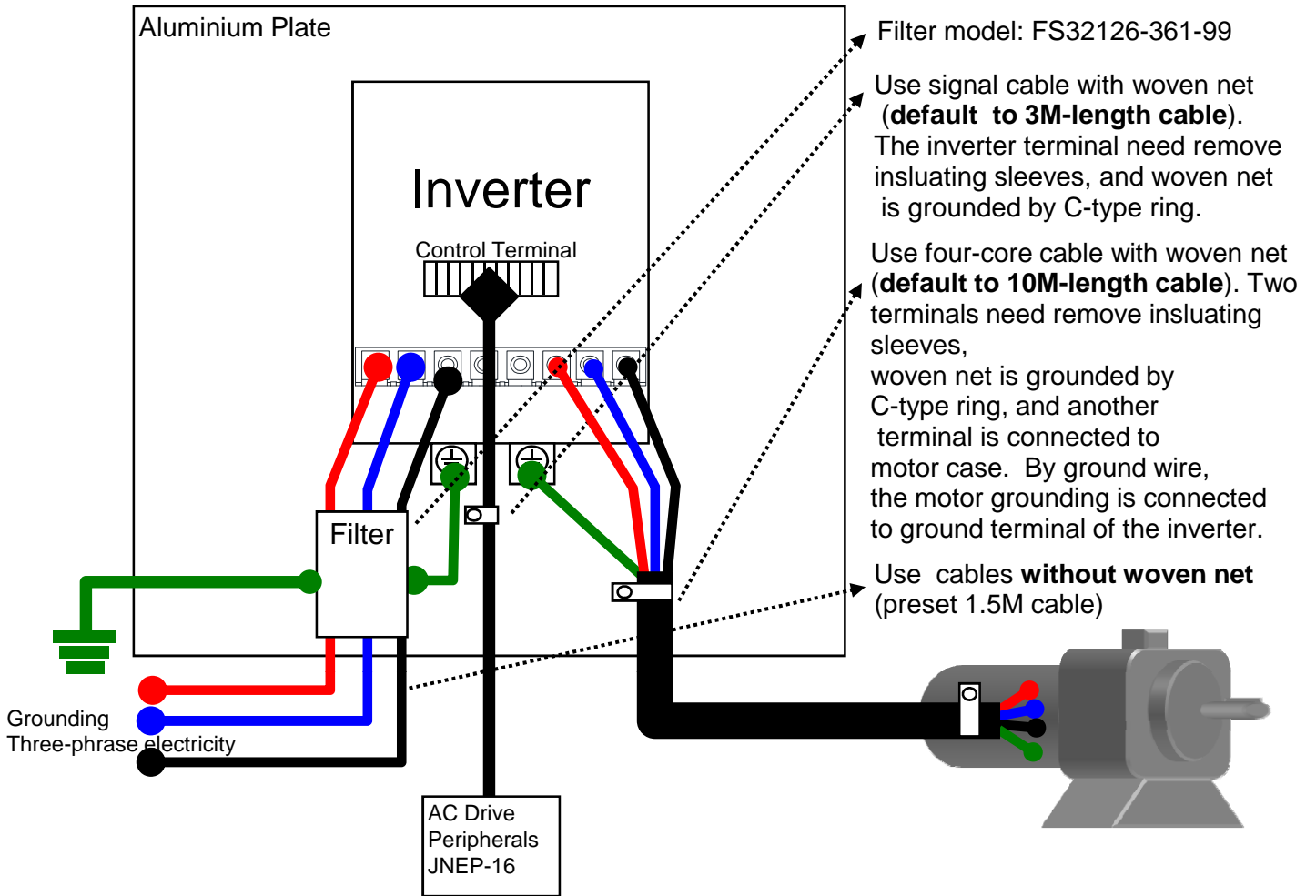

T310 F7~F8 EMI Configuration 1

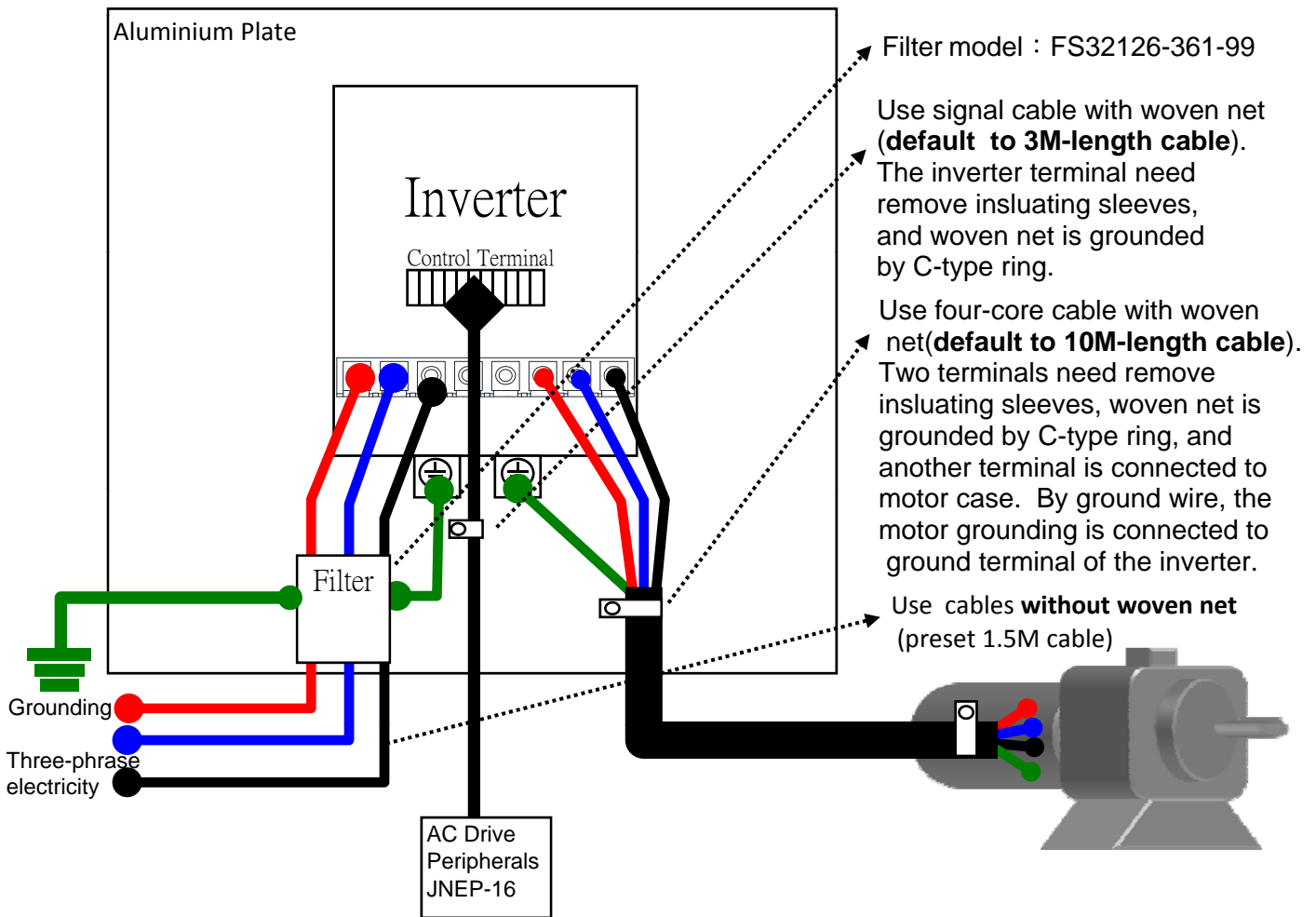

C-5

www.famcocorp.com

E-mail: info@famcocorp.com

@famco_group

Tel: ۰۲۱-۴۸۰۰۰۰۴۹

Fax: ۰۲۱-۴۴۹۹۴۶۴۲

تهران، کیلومتر ۲۱ بزرگراه لشگری (جاده مخصوص کرج)

روبروی پالایشگاه نفت پارس، پلاک ۱۲