

Steam trapping overview



Make your steam system safe, efficient and sustainable

The duty of a steam trap is to discharge condensate while retaining live steam in the system. This ensures your steam system is able to operate efficiently, without the detrimental effects of unwanted condensate - essential in temperature critical applications.

Condensate in the system can lead to a number of issues such as:

- Poor heat transfer
- Damage to system and process equipment
- Poor quality or wasted product

Selecting the right steam trapping solution helps to avoid these problems, whilst at the same time allowing the condensate to be recovered. Information on the significant benefits of recovering condensate can be found at the back of this brochure.

How can Spirax Sarco help you?

We've been in the business of steam solutions for over 100 years and with our exceptional team of specialists, we take the time to understand your needs and work with you to find the most effective steam trapping solutions for your applications.

Our aim is to help you meet your sustainability and efficiency goals by ensuring your steam system operates at its optimum level at all times. Effective steam trapping is a key factor in achieving this objective.





An introduction to steam traps

Each steam application has its own steam trap requirements. Selecting the right steam trap for your application could have a significant, positive impact on your process, potentially improving efficiency, reducing energy costs and giving you a safer working environment.

For example: condensate must be removed promptly from a plant where maximum heat transfer is sought at all times. The presence of excess condensate in an item of heat transfer equipment will reduce its efficiency, preventing it from achieving its maximum rated output and may also reduce its service life.

However; in other applications, it may be required to hold back the condensate to extract some of its heat and thus save on steam. Furthermore, by discharging condensate well below steam temperature, flash steam losses can be reduced or avoided altogether.

Thermodynamic steam traps

Maintaining optimum process performance

Thermodynamic steam traps are the best choice for steam mains drainage due to their simplicity, long life and robust construction. With a large condensate capacity for their size, the all stainless steel construction of our thermodynamic traps offer a high degree of resistance to corrosive condensate.



Mechanical steam traps

Maintaining optimum process performance

Mechanical steam traps are ideal for use on process applications where condensate must be removed as soon as it forms, to safeguard against temperature fluctuation which would lead to issues such as product spoilage and inadequate heating. Our mechanical steam trap range is adaptable to all applications where instantaneous removal of condensate is required.



Thermostatic steam traps



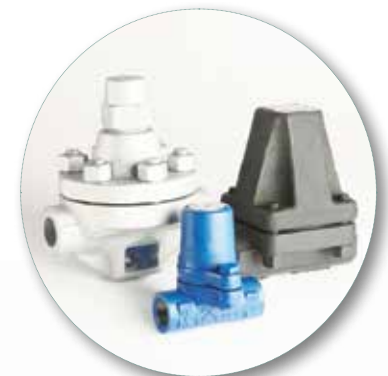

Utilising heat energy in condensate

For applications where it would be desirable to make use of the heat in the condensate such as sterilisation, a thermostatic steam trap is an ideal solution as it will not open until the condensate temperature drops below saturated steam temperature. This allows the heat in the condensate to be utilised before it is drained off which in turn reduces flash steam losses and can help to reduce energy costs.



Spirax Sarco offers a complete range of steam traps to ensure you can select the perfect trap for your application.

Spirax Sarco's steam trap range

Steam trap operation	Thermodynamic	Mechanical		Thermostatic	
Steam trap types	Thermodynamic 	Ball float 	Inverted bucket 	Balanced pressure 	Bimetallic 
Main features	<ul style="list-style-type: none"> Robust design giving excellent resistance to waterhammer and vibration Inexpensive Positive discharge with tight shut-off Discharge condensate close to steam saturation temperature 	<ul style="list-style-type: none"> High capacity Excellent air venting capabilities Continuous discharge of condensate for maximum heat transfer Will not back-up with condensate 	<ul style="list-style-type: none"> High capacity Robust design Near continuous discharge of condensate Minimal back-up of condensate 	<ul style="list-style-type: none"> Utilises sensible heat in the condensate, reducing flash steam losses, which saves energy Excellent air venting properties for quick start-up 	
Typical applications	<ul style="list-style-type: none"> Mains drainage and all tracing applications Some process applications with light loads such as small presses and cylinders 	<ul style="list-style-type: none"> Temperature/pressure controlled applications with fluctuating loads 	<ul style="list-style-type: none"> Temperature/pressure controlled applications with fluctuating loads 	<ul style="list-style-type: none"> Where condensate back-up can be tolerated or is required in order to remove excess enthalpy, e.g. non-critical tracing 	
Size	DN8 – DN25 (¼" – 1")	DN15 – DN100 (½" – 4")	DN15 – DN50 (½" – 2")	DN8 – DN25 (¼" – 1")	DN8 – DN100 (¼" – 4")
Maximum body rating	PN250	PN100 and ASME Class 600	ASME 900	PN40 and ASME Class 300	ASME Class 600
Maximum operating pressure	250 bar g	80 bar g	110 bar g	32 bar g	70 bar g

Thermodynamic steam traps

How a thermodynamic steam trap works

1. On start-up, incoming pressure raises the disc and cooled condensate, and air is immediately discharged.
2. Hot condensate flowing through the trap releases flash steam. High velocity creates a low pressure area under the disc and draws it towards the seat.
3. At the same time there is a pressure build-up of flash steam in the chamber above the disc which forces it down against the pressure of the incoming condensate until it seats on the inner ring and closes the inlet. The disc also seats on the outer ring and traps pressure in the chamber.
4. Pressure in the chamber is decreased by condensation of the flash steam and the disc is raised. The cycle is then repeated.

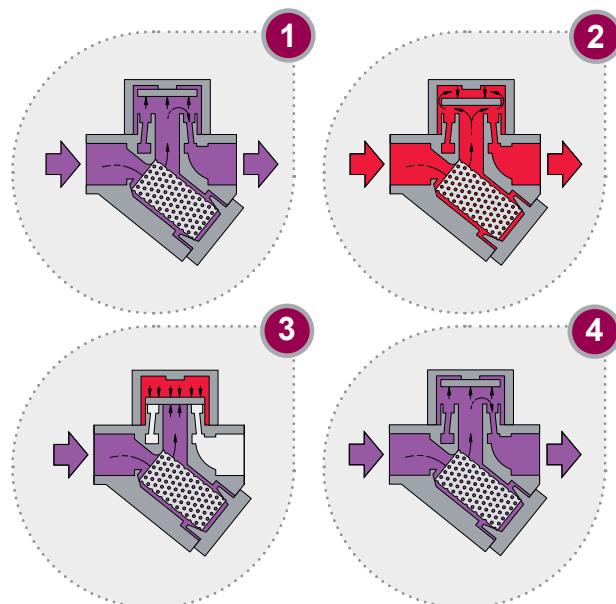

Features and benefits:

- Positive condensate discharge with clean tight shut-off
- Discharges condensate at very close to steam temperature that ensures maximum plant efficiency
- Just one moving part, a disc, ensures reliable operation and minimal maintenance without having to remove from the line
- Compact and light weight, reducing installation costs
- Hardened disc and seat for long life
- One trap covers a wide range of operating pressures making selection and replacement simple
- Insulating cover for low ambient temperature or wet environments
- Thermodynamic traps can be used on high pressure and superheated steam and are not affected by waterhammer or vibration.

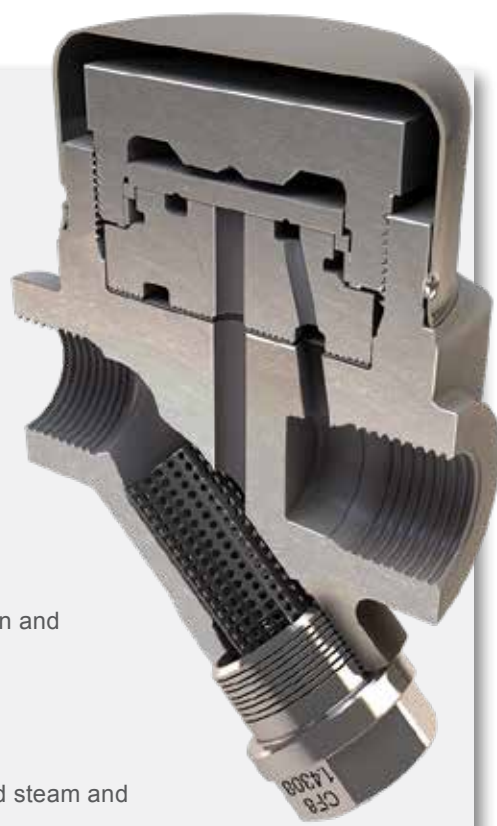

Thermodynamic steam traps - product range

Material	Maximum operating pressure	Connection	Sizes					Recommended installation
			DN8 1/4"	DN10 3/8"	DN15 1/2"	DN20 3/4"	DN25 1"	
Carbon steel	42 bar g	Socket weld			TD42S2 TD42S2LC			Horizontal
	46 bar g	Screwed Socket weld Flanged			TDC46M			Horizontal
Stainless steel	10 bar g	Screwed	TD10					Horizontal
	26 bar g	Swivel			UTD26LY / UTD26L UTD26HY / UTD26H (universal connection)			Universal
	30 bar g	Swivel			UTD30L UTD30H (universal connection)			Universal
	32 bar g	Flanged			TD32F TD32FLC			Horizontal
	42 bar g	Screwed	TD 259 TD52M	TD42LC TD42L TD52M	TD42 TD42LC TD42H TD42L TD52M TD52MLC	TD42 TD42H TD42L TD52M	TD42H TD42L TD52M	Horizontal
	46 bar g	Swivel	UTDS46M					Universal
	46 bar g	Screwed Socket weld Flanged			TDS46M			Horizontal
Alloy steel	62 bar g	Screwed Socket weld Flanged			TD62M TD62LM			Horizontal
	250 bar g	Socket weld Butt weld Flanged			TD120M			Horizontal
Stainless steel (Clean steam)	10 bar g	Screwed	BTD52L					Horizontal
		Clamp Tube end			BTD52L			Horizontal

Mechanical steam traps

Ball float mechanical steam traps

Ball float (FT) mechanical steam traps have an integral air vent as standard and the options of a manually adjustable needle valve (SLR - steam lock release mechanism) and drain cock tapping, the FT range is adaptable to all applications where ball float traps are recommended and instantaneous removal of condensate is required.

How a ball float steam trap works

1. On start-up a thermostatic air vent allows air to bypass the main valve (1) which would otherwise be unable to escape (a condition known as 'air-binding').

2. As soon as condensate reaches the trap, the float is raised and the lever mechanism opens the main valve. Hot condensate closes the air vent but continues to flow through the main valve.

3. When steam arrives the float drops and closes off the main valve, which remains at all times below the water level, ensuring that live steam cannot be passed.

4. As the steam condenses, the float rises allowing condensate to be released.

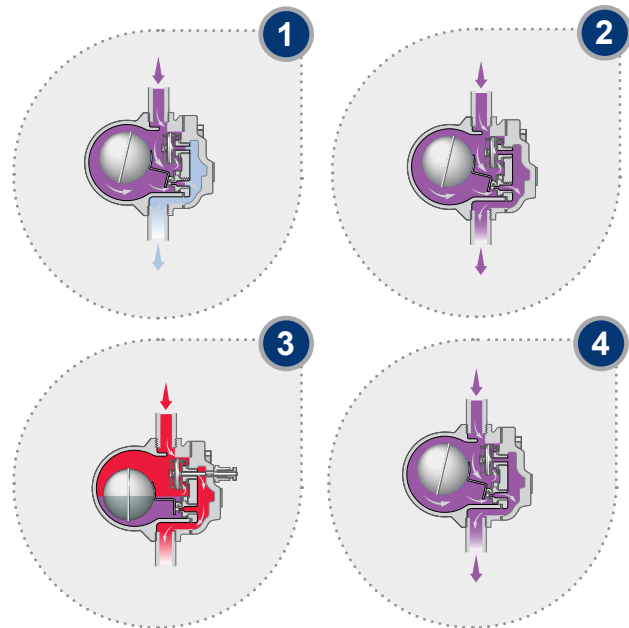

Features and benefits:

- Immediate condensate discharge with clean, tight shut-off. No backup of condensate ensures maximum plant efficiency
- Works efficiently on both heavy and light loads with no passage of live steam
- Not affected by wide and sudden fluctuations of pressure or flowrate
- Stainless steel internals that can tolerate corrosive condensate
- Integral air vent to ensure rapid warm-up of plant
- Robust construction to guarantee long life against waterhammer and vibration

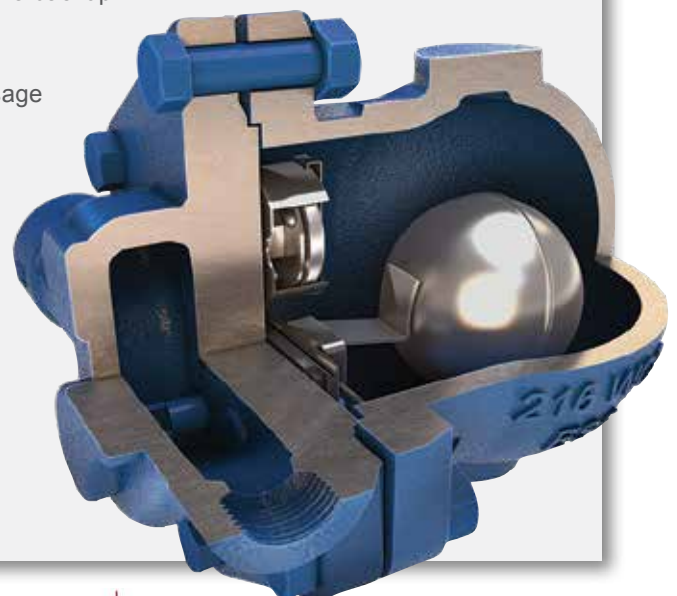

Ball float steam traps - product range

Material	Maximum operating pressure	Connection	Sizes								Installation	
			DN15 ½"	DN20 ¾"	DN25 1"	DN32 1¼"	DN40 1½"	DN50 2"	DN80 3"	DN100 4"		
Cast iron	13 bar g	Flanged			FT43		FT43 FT53		FT43		Horizontal	
					FT43V		FT43V FT53V				Vertical down	
	14 bar g	Screwed					FT14				Horizontal	
SG iron	14 bar g	Screwed	FT14								Horizontal	
			FT14V								Vertical down	
		Flanged	FT14								Horizontal	
	21 bar g	Screwed			FT14HC	FT14					Horizontal	
	32 bar g	Flanged	FT47 FT57				FT47 FT57				Horizontal	
		Flanged	FT47V				FT47V				Vertical down	
ENP coated SG iron cover and stainless steel body	14.6 bar g	Screwed	FTGS14								Horizontal	
		Flanged	FTGS14								Horizontal	
	17 bar g	Screwed			FTGS14HC						Horizontal	
Carbon steel	23 bar g	Flanged					FTC23				Horizontal	
	32 bar g	Screwed Socket weld	FTC32						FT450*		Horizontal	
			FTC32V								Vertical down	
		Flanged	FTC32 FT44 FT54		FT44 FT54			FT44 FT54	FT44 FT450*			Horizontal
			FTC32V FT44V FT54V		FT44V FT54V			FT44V FT54V				Vertical down
	80 bar g	Socket weld Flanged					FTC80				Horizontal	
Screwed Socket weld Flanged		FTC62								Horizontal		
Stainless steel	23 bar g	Flanged					FTS23				Horizontal	
	19 bar g	Screwed Socket weld Flanged	FTS14								Horizontal	
			FTS14V								Vertical down	
	25.5 bar g	Flanged	FT46					FT46			Horizontal	
	32 bar g	Swivel	UFT32								Universal	
65.8 bar g	Screwed Socket weld Flanged	FTS62								Horizontal		
Stainless steel (Clean steam)	4.5 bar ΔP	Clamp	FTS14-4.5								Horizontal	
			FTS14V-4.5								Vertical down	

Mechanical steam traps

Inverted bucket mechanical steam traps

Our inverted bucket steam traps employ a well-proven principle which relies on the difference in density between steam (a vapour) and condensate (a liquid). They have a robust design and incorporate a simple density sensitive bucket and lever mechanism.

How an inverted bucket steam trap works

1. As condensate reaches the trap it forms a water seal inside the body. The weight of the bucket keeps the valve off its seat. Condensate can then flow around the bottom of the bucket and out of the trap.

2. When steam enters the underside of the bucket it gives it buoyancy and the bucket rises. This positions the lever mechanism such that the main valve 'snaps' shut due to flow forces.

3. The bucket will lose its buoyancy as the enclosed steam condenses due to radiation losses and steam escapes through the vent hole. Once this happens the weight of the bucket will pull the valve off its seat and the cycle is then repeated.

4. Any air reaching the trap will also give the bucket buoyancy and close the valve preventing condensate flow. The small vent hole positioned at the top of the bucket will lead air into the top of the trap. Because the vent hole at the top of the bucket is small in diameter it will vent air very slowly. Where the venting of air may be a particular problem, this can be overcome simply by fitting an external air vent in parallel.

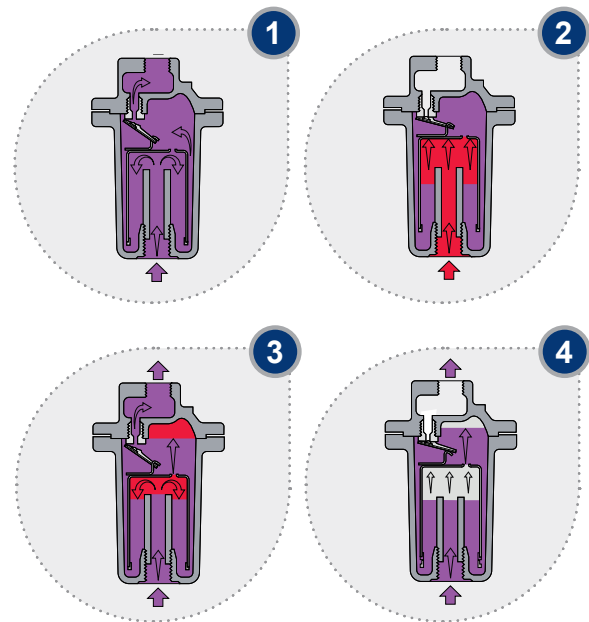

Features and benefits:

- Near continuous condensate discharge with tight shut-off. Minimal back-up of condensate ensures maximum plant efficiency
- Deep water-seal to protect against the possibility of steam loss
- Suitable for superheat conditions when fitted with internal inlet check valve
- Simple and robust construction to guarantee long life against waterhammer and vibration
- Stainless steel internals are attached to the cover for ease of maintenance
- Integral strainer (HM, HM34 and SCA models only)
- Optional blowdown valve (only for HM and HM34)



Inverted bucket steam traps - product range

Material	Maximum operating pressure	Connection	Sizes						Installation
			DN15 1/2"	DN20 3/4"	DN25 1"	DN40 1 1/2"	DN50 2"	DN80 3"	
Cast iron	13 bar g	Screwed Flanged	S SF						Horizontal
	14 bar g	Screwed Flanged	HM					Horizontal	
	22 bar g	Screwed Flanged	200					Vertical	
Carbon steel	32 bar g	Screwed Socket weld Flanged	HM34					Horizontal	
	41 bar g	Screwed Socket weld Flanged	SCA					Horizontal	
	116 bar g	Screwed Socket weld Flanged	IBV Series C IBV Series C-LDF2						Vertical
Stainless steel	30 bar g	Screwed Socket weld Flanged	SIB30 SIB30H					Horizontal	
		Swivel	UIB30 UIB30H					Universal	
	60 bar g	Screwed Flanged	SIB45					Horizontal	
	63 bar g	Swivel	UIB46					Universal	
Alloy steel	123 bar g	Screwed Socket weld Flanged	IBV Series Z						Vertical

Thermostatic steam traps

How a balanced pressure thermostatic steam trap works

1. On start-up, cold air and condensate enter the trap. As the capsule is also cold, the valve is open and the air and condensate are discharged.

2. The capsule warms up as the condensate approaches steam temperature. Its liquid filling boils, and the resultant vapour pressure acting on the diaphragm pushes the valve head towards the seat, fully closing at the selected discharge temperature before any steam is lost.

3. As the condensate within the trap cools, the vapour filling condenses and the internal capsule pressure falls. The valve reopens, discharges condensate and the cycle repeats.

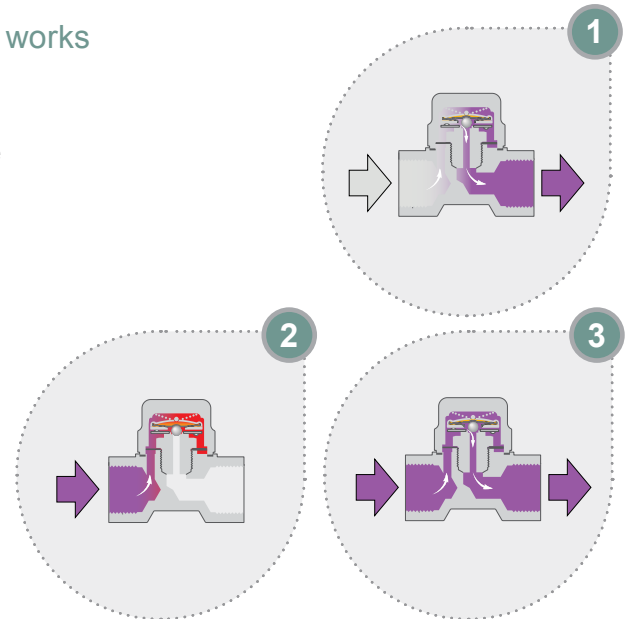

Features and benefits:

- Condensate is discharged at below steam saturation temperature, utilising sensible heat in the condensate and reducing flash steam losses
- Automatically discharges air and other incondensable gases to aid rapid warm-up of plant
- It automatically adjusts itself to variations of steam pressure up to its maximum operating pressure and can tolerate superheat up to 70°C
- Discharge temperature set by capsule selection - no requirement to adjust on site
- Manufactured using advanced technology to exacting quality standards
- All stainless steel internals extend working life and reduce plant maintenance
- The BPC32 and BPS32 series has a two bolt cover design for ease of maintenance

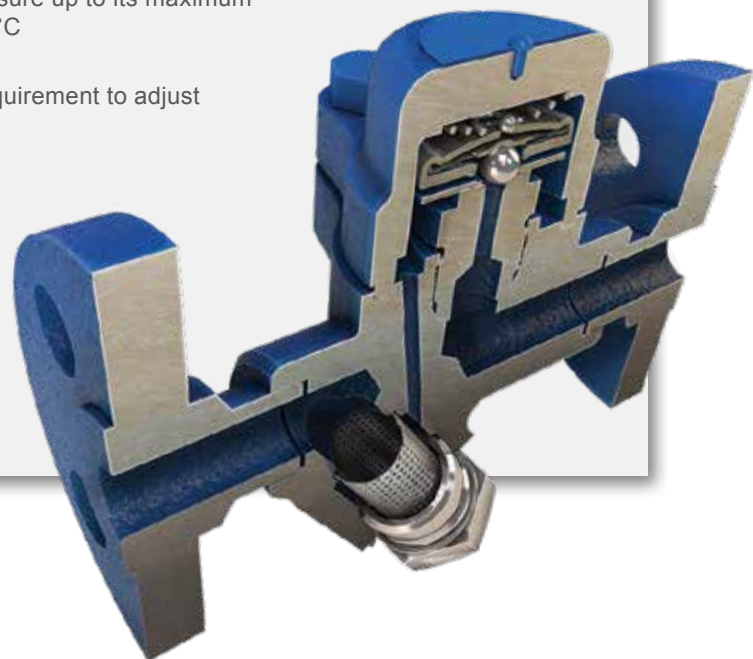

Balanced pressure thermostatic steam traps - product range

Material	Maximum operating pressure	Connection	Sizes						Recommended installation
			DN8 1/4"	DN10 3/8"	DN15 1/2"	DN20 3/4"	DN25 1"	DN40 1 1/2"	
Brass	13 bar g	Screwed			BPT13S BPT13US				Horizontal
					BPT13A BPT13UA				Angle
Carbon steel	21 bar g	Screwed			BPM21L				Horizontal
		Socket weld			BPM21L				Horizontal
	32 bar g	Screwed Socket weld			BPC32 BPC32Y				Horizontal
		Flanged			BPC32 BPC32F BPC32Y BPC32YF				Horizontal
Stainless steel	21 bar g	Screwed	MST21		MST21 MST21H TSS21	MST21H			Vertical down
		Sandwich between flanges			BPW32				Vertical down
	30 bar g	Screwed Socket weld Flanged			SBP30				Horizontal
	32 bar g	Screwed Socket weld Flanged			BPS32 BPS32Y				Horizontal
		Swivel			UBP32				Universal
Stainless steel (Clean steam)	7 bar g	Screwed	BTM7 BTS7		BTM7 BTS7				Vertical down
		Clamp			BTM7 BTS7 BTS7.1				Vertical down
		Tube end	BTM7 BTS7						Vertical down
	6 bar g	Clamp Tube end			BT6-BH BT6-BL				Vertical down

Thermostatic steam traps

How a bimetallic thermostatic steam trap works

1. On start-up, the bimetallic element is relaxed and the valve is open. Cooled condensate, plus air, is immediately discharged.
2. Hot condensate flowing through the trap heats the bimetallic element causing it to pull the valve towards the seat.
3. As the hot condensate is discharged and approaches steam saturation temperature the bimetallic element closes the valve. When there is no flow through the trap the condensate surrounding the element cools causing it to relax and the upstream pressure opens the valve. Condensate is discharged and the cycle repeats.

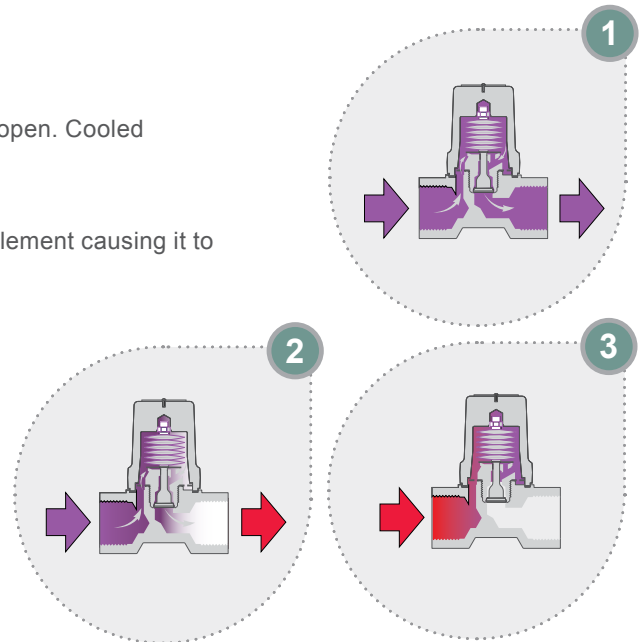

Features and benefits:

- Condensate is discharged at below steam saturation temperature, utilising sensible heat in the condensate and reducing flash steam losses
- Automatically discharges air and other incondensable gases to aid rapid warm-up of plant
- The bimetal elements can work over a wide range of steam pressures without any need for on-site adjustment
- Resistant to waterhammer and freezing
- The SMC32 series has a two bolt cover design for ease



Bimetallic thermostatic steam traps - product range

Material	Maximum operating pressure	Connection	Sizes									Recommended installation	
			DN8 1/4"	DN10 3/8"	DN15 1/2"	DN20 3/4"	DN25 1"	DN40 1 1/2"	DN50 2"	DN80 3"	DN100 4"		
Carbon steel	21 bar g	Socket weld Butt weld Flanged									SP80	SP100	Horizontal
	32 bar g	Screwed Socket weld Butt weld			SMC32 SMC32Y								Horizontal
		Flanged			SMC32 SMC32F SMC32Y SMC32YF								Horizontal
	45 bar g	Screwed Socket weld Butt weld Flanged			HP45								Horizontal
Stainless steel	17 bar g	Screwed	T3										Vertical down
	21 bar g	Swivel			USM21								Universal
	32 bar g	Swivel			USM32								Universal
		Screwed Socket weld Flanged			PBX								Horizontal
Alloy steel	45 bar g	Screwed Socket weld Butt weld Flanged			SM45								Horizontal
	70 bar g	Socket weld Butt weld			HP70								Horizontal

Reducing production running costs

Spirax Sarco can supply fabricated steam trap stations and a range of 'quick-fit' solutions that will allow rapid steam trap replacement and significantly reduce labour costs.



Universal steam traps for use with pipeline

UTD26L, UTD26LY and
UTD26H, UTD26HY
up to 26 bar g

Thermodynamic
steam trap



UTDS46M
up to 46 bar g*

Thermodynamic
steam trap



Key features:

- A simple two-bolt connector design allows quick and simple maintenance of a steam trap - Reducing system downtime and maintenance costs compared to traditional trapping stations
- Single permanent in-line component for ease of specification and installation
- Prefabricated construction minimises on-site fabrication and the welded joints eliminate potential leak paths
- All stainless steel construction for maximum system life

Pipeline connectors

PC10HP
up to 62 bar g*



PC20
up to 32 bar g

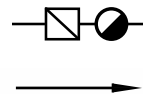

PC30 series
up to 62 bar g*

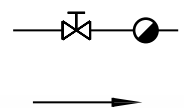

connectors for a 'quick fit'.

UFT32
up to 32 bar g
Ball float steam trap



UIB30/UIB30H
up to 30 bar g
UIB45
up to 63 bar g*
Inverted bucket steam trap



UBP32
up to 32 bar g
Balanced pressure steam trap



USM21
up to 21 bar g
USM32
up to 32 bar g
Bimetallic steam trap



The pipeline connectors require 2 bolts for connection with a steam trap.

*subject to limitation of pipeline connector

Steam trapping station

PC3000 series
up to 62 bar g*

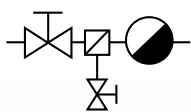

PC40 series
up to 62 bar g*

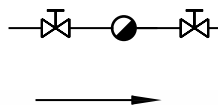

PC4000 series
up to 62 bar g*

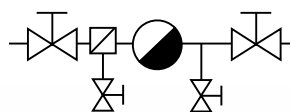

STS17.2
up to 17.5 bar g

Steam trapping station

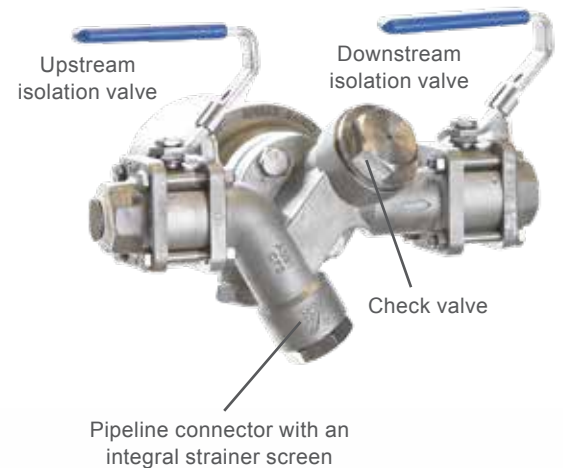

* Subject to pressure limits of trap selected

Steam tracing using our compact dual duty manifold

Steam tracing is used principally to maintain a reasonable product temperature and viscosity in order to simplify pumping, avoid freezing, solidification and stagnation. Although the rates of condensate are relatively small, trap populations will be large since all tracer lines should be individually trapped. For ease of design and layout, the condensate from the traps is collected in a manifold. The steam to the tracers can be distributed utilising a similar manifold arrangement.

Our forged MSC series manifold minimises on-site fabrication and testing.

Key features:

- Minimises on-site fabrication and testing
- Lower cost than conventional welded design
- Shortens project lead times
- Space saving with standardised design
- Lightweight to support and easy to install with optional mounting kit
- Easy to maintain
- Optional insulation jacket for energy conservation

Manifold type	Number of tracer connections	DN		Tracer connections			EN 10204 3.1.B certification	Options	
		15	20	BSP	NPT	SW		Insulation jacket	Mounting kit
MSC04	4	•	•	•	•	•	Standard	•	•
MSC08	8	•	•	•	•	•	Standard	•	•
MSC12	12	•	•	•	•	•	Standard	•	•

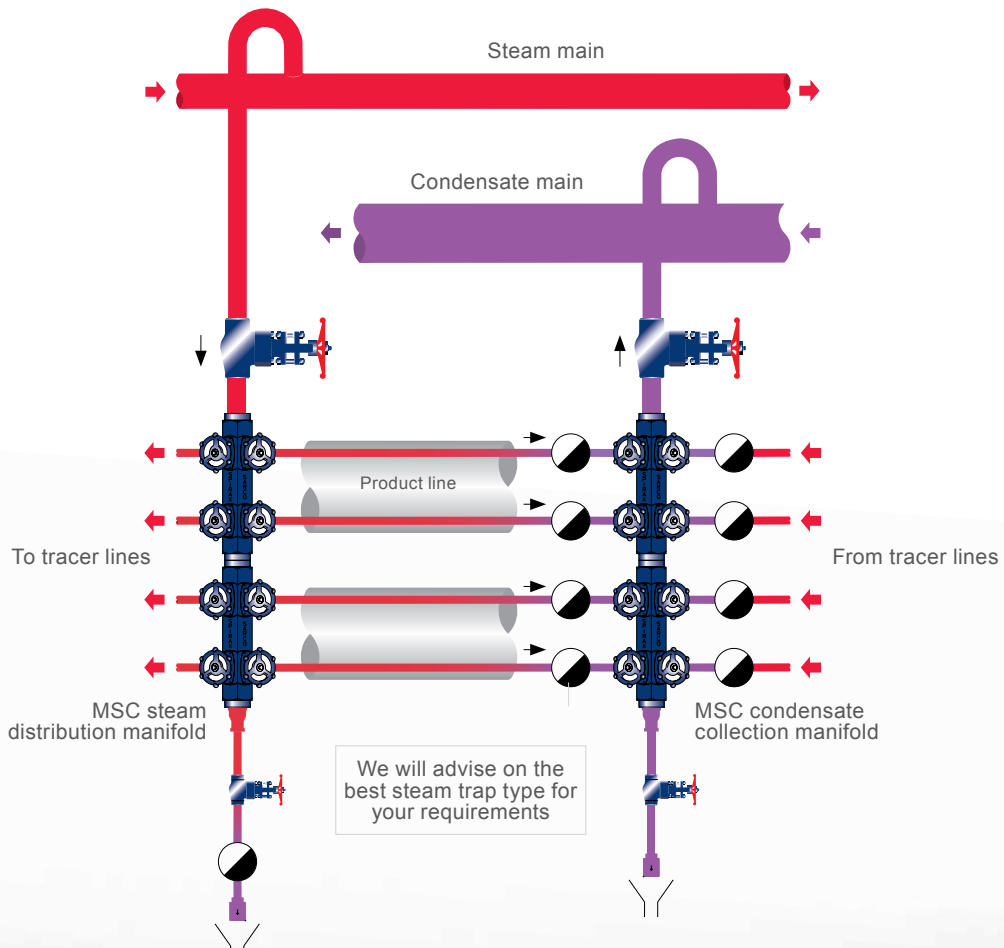

Typical applications for steam traps

Mains drainage

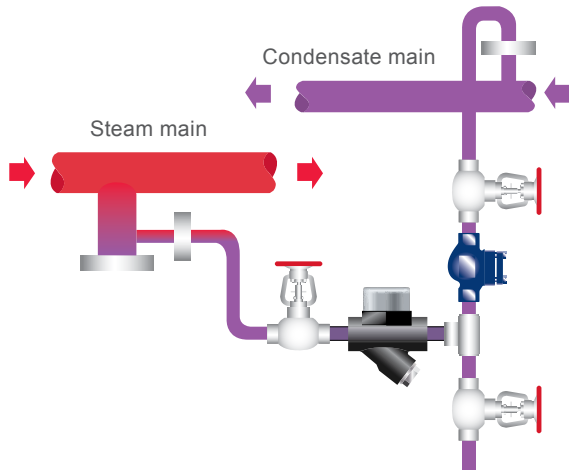

Vulcaniser application

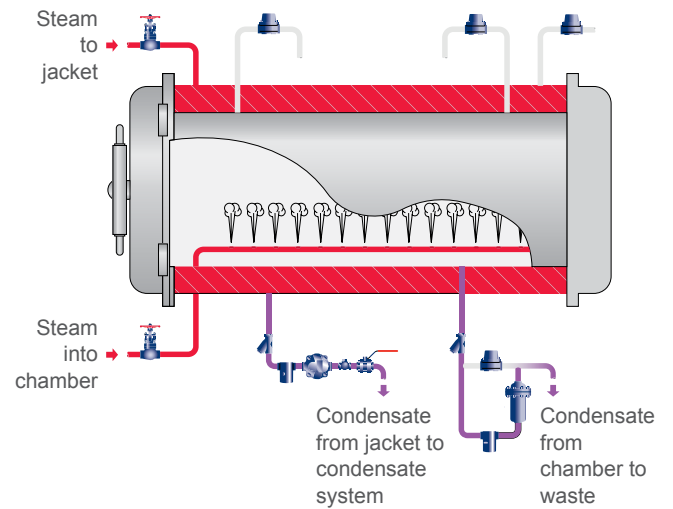

Hot plate process

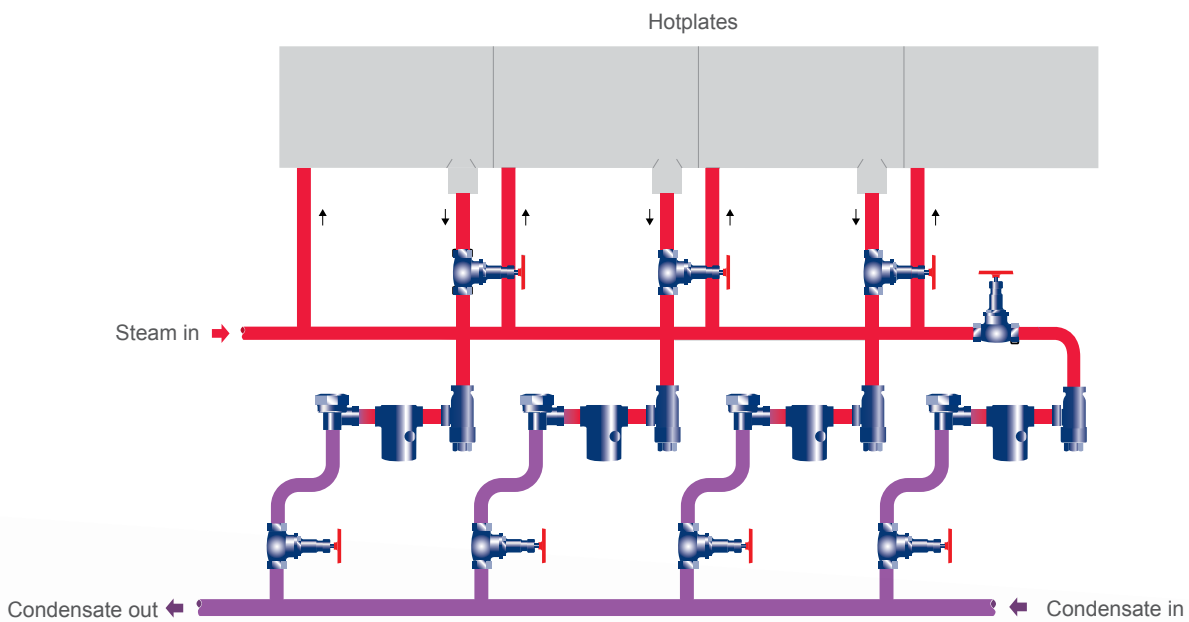

Process equipment

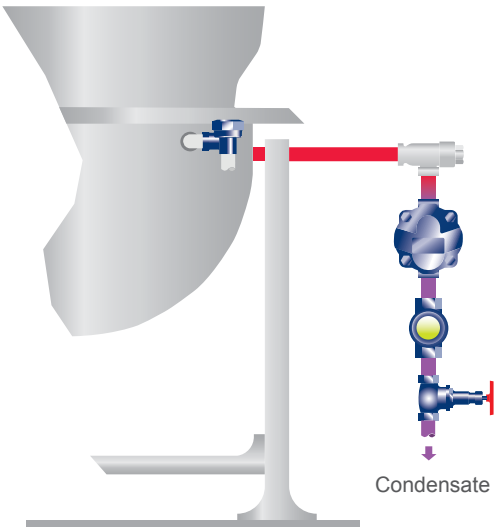

Turbine drainage

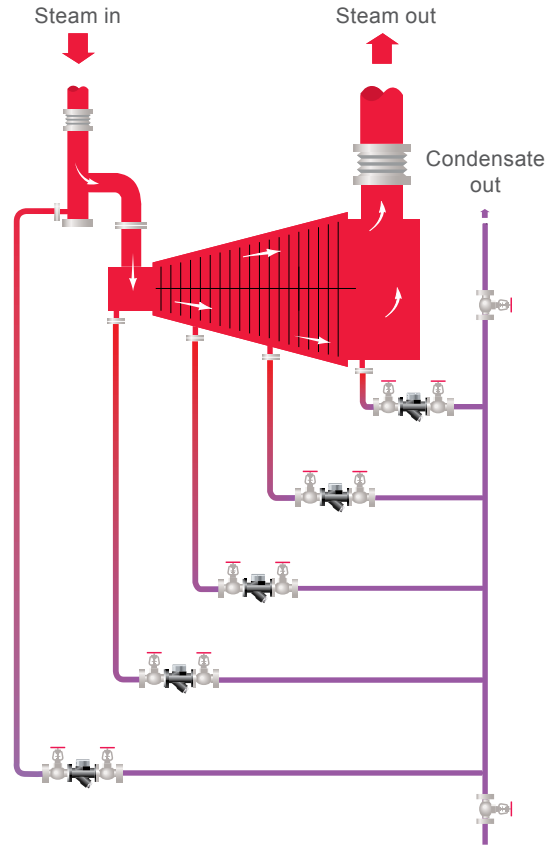

Drainage of a separator

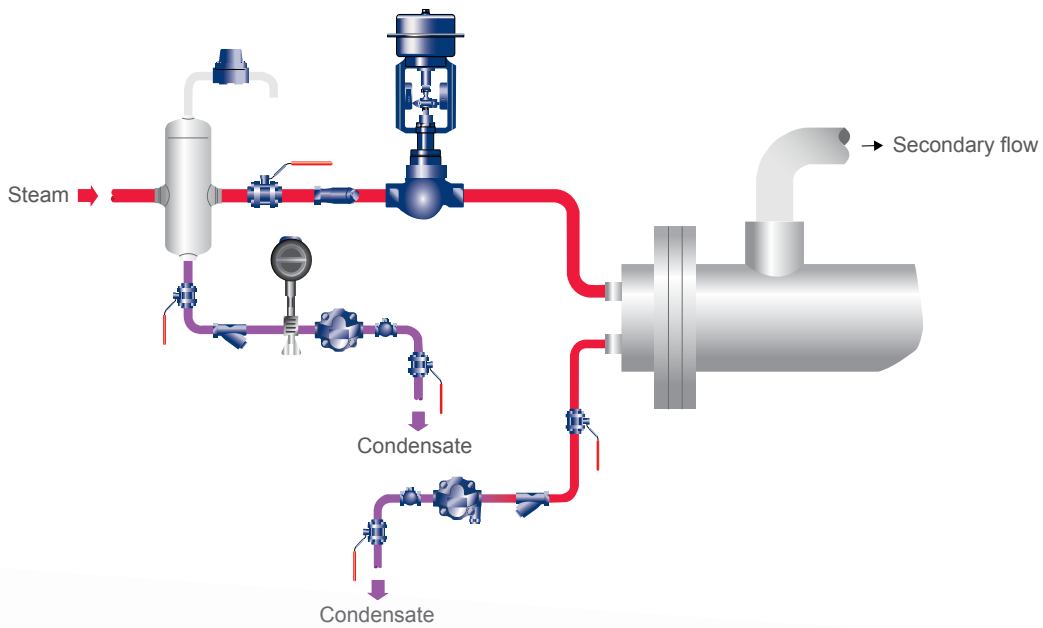

The benefits of effective steam trapping

Spirax Sarco are focused on helping our customers achieve process efficiency, increased production output and energy savings, and we know the importance of effective steam trap management in achieving this. A healthy steam trap population allows condensate to be removed from the steam system effectively which means it can be re-used. We call this 'condensate recovery' and it saves energy and cost in a number of different ways:

Reduced fuel costs

Normally, condensate will contain around 25% of the usable energy of the steam from which it came. Returning this to the boiler feedtank can save thousands of pounds per year in energy alone.

Energy saving

Condensate returned to the feedtank reduces the need for boiler blowdown, which is used to reduce the concentration of dissolved solids in the boiler. This therefore reduces the energy lost from the boiler during the blowdown process.

Reduced water charges

Returning and re-using condensate reduces the requirement for fresh replacement water.

Reduced chemical treatment costs

Re-using as much condensate as possible minimises the need for costly chemicals to treat raw water.

Reduced effluent costs

In many countries there are restrictions on releasing effluent at elevated temperatures so it must be cooled if discharged which incurs extra costs.

Spirax Sarco are always on hand to advise you about the best ways to manage your steam system and to help ensure you continue to reap these benefits.



For more information about our steam trapping solutions, or any of our other solutions and services please visit spiraxsarco.com.

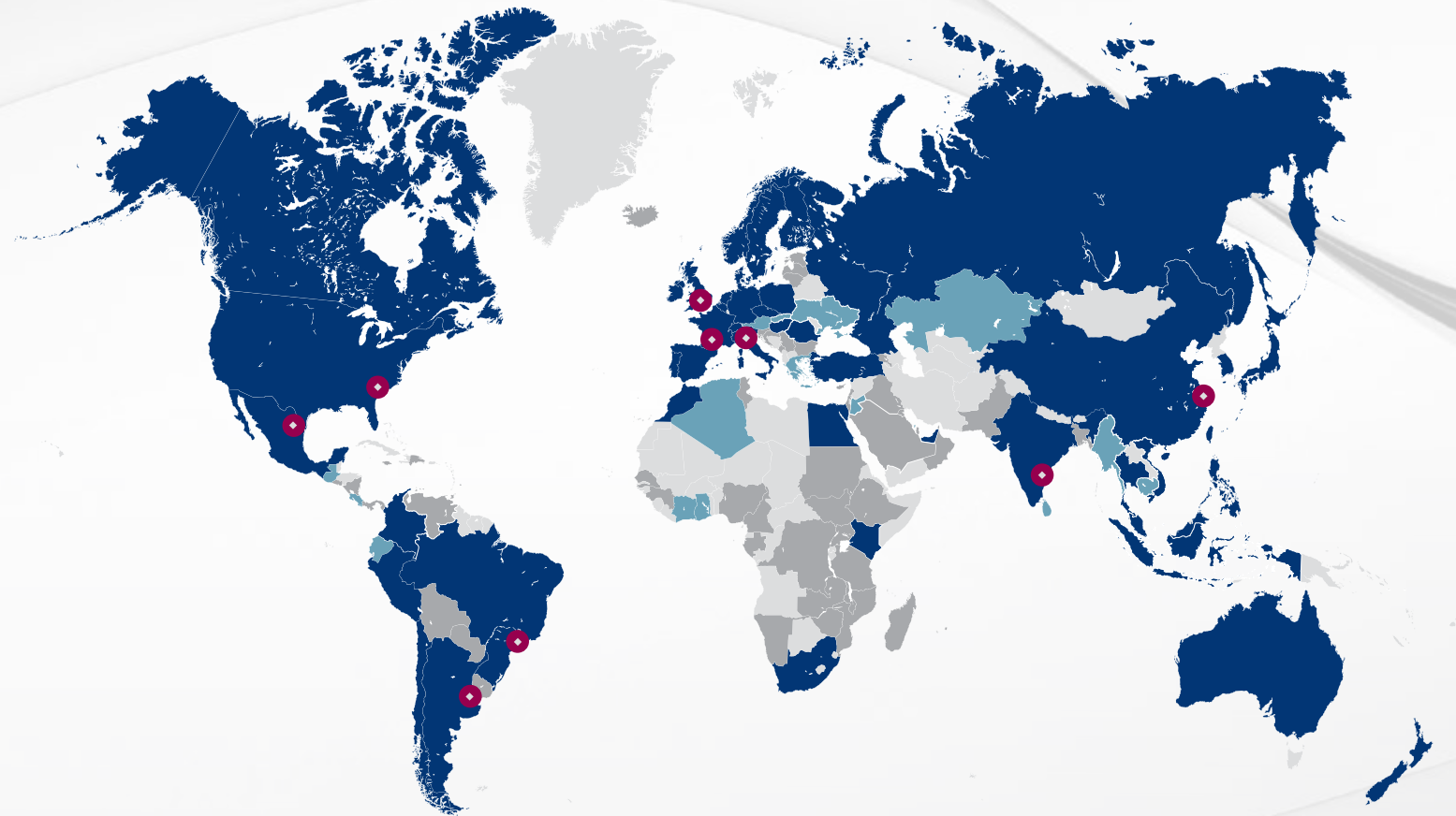

Operating Companies

Manufacturing Sites

Sales Offices

Distributors

spirax
sarco

 www.famcocorp.com

 E-mail: info@famcocorp.com

 @famco_group

 Tel: ۰۲۱-۴۸۰۰۰۰۴۹

 Fax: ۰۲۱-۴۴۹۹۴۶۴۲

تهران، کیلومتر ۲۱ بزرگراه لشگری (جاده مخصوص کرج)

روبروی پالایشگاه نفت پارس، پلاک ۱۲