

2

Insert bearings (Y-bearings)



2 Insert bearings (Y-bearings)



Designs and variants	341	Mounting and dismounting	359
Insert bearings with grub screws	342	Assembling insert bearings into housings with fitting slots	362
Basic design bearings	342	SKF ConCentra insert bearings	363
Bearings with zinc-coated rings	342		
Stainless steel bearings	342	Designation system	364
Insert bearings with an eccentric locking collar	343		
SKF ConCentra insert bearings	344	Product tables	
Insert bearings with a tapered bore	344	2.1 Insert bearings with grub screws, metric shafts . . .	366
Insert bearings with a standard inner ring	345	2.2 Insert bearings with grub screws, inch shafts.	368
Sealing solutions.	345	2.3 Insert bearings with an eccentric locking collar, metric shafts	372
Standard seals	345	2.4 Insert bearings with an eccentric locking collar, inch shafts	374
Standard seals with additional flingers	345	2.5 SKF ConCentra insert bearings, metric shafts	376
Multiple seals	346	2.6 SKF ConCentra insert bearings, inch shafts	377
5-lip seals	346	2.7 Insert bearings with a tapered bore on an adapter sleeve, metric shafts	378
RS1 seals.	346	2.8 Insert bearings with a tapered bore on an adapter sleeve, inch shafts	379
Shields.	346	2.9 Insert bearings with a standard inner ring, metric shafts	380
Cages.	347		
Rubber seating rings.	347		
Lubrication	348		
Greases for capped bearings	348		
Grease life for insert bearings.	348		
Relubrication.	348		
Bearing data	350		
(Dimension standards, tolerances, radial internal clearance, permissible misalignment)			
Loads	353		
(Minimum load, axial load carrying capacity, equivalent dynamic bearing load, equivalent static bearing load)			
Temperature limits	355		
Permissible speed	355	Other insert bearings (Y-bearings)	
Design considerations	356	High temperature bearings	1005
Axial displacement	356	Bearings with Solid Oil	1023
Shaft tolerances	358	Bearings with a customized design or customized dimensions	→ contact SKF
		Ball bearing units (Y-bearing units)	→ skf.com/bearings

2 Insert bearings (Y-bearings)

2



More information

General bearing knowledge 17

Bearing selection process 59

SKF bearing maintenance handbook ISBN 978-91-978966-4-1

Insert bearings (SKFY-bearings) are based on sealed deep groove ball bearings in the 62 and 63 series, but have a convex outer ring and in most cases an extended inner ring with a specific locking device (fig. 1), enabling quick and easy mounting onto the shaft.

Bearing features

- **Quick and easy to mount**
The different locking methods enable quick and easy mounting of insert bearings onto the shaft.
- **Accommodate initial misalignment**
The spherically shaped outside surface enables initial misalignment by tilting in the housing (fig. 2).
- **Long service life**
The different sealing solutions available provide a long service life for a wide variety of applications with high contamination levels.
- **Reduced noise and vibration levels**
Where high requirements on noise and vibration levels are important, SKF can provide the appropriate shaft locking method.

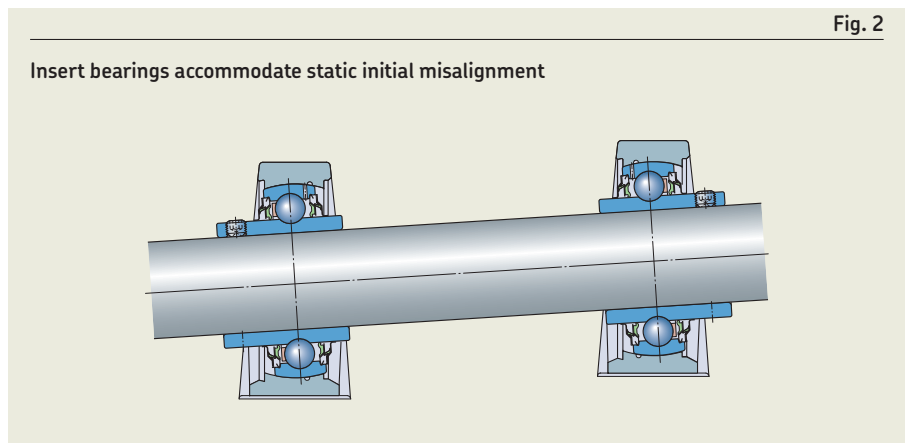

Typical applications

Because of their versatility and cost-effectiveness, insert bearings are typically used in the following applications:

- Agricultural machinery
- Food and beverage processing and packaging
- Conveyor systems
- Material handling systems
- Textile equipment
- Industrial fans
- Special machinery, e.g. car wash systems, gym equipment, go-karts

Ball bearing units (Y-bearing units)

SKF also supplies a wide variety of ball bearing units that are not listed in this rolling bearing catalogue. For information about ball bearing units, refer to the product information available online at skf.com/bearings.

Designs and variants

Insert bearings typically have a spherically shaped (convex) outside surface and an extended inner ring (fig. 3) with different types of locking device. The various insert bearing series differ in the way the bearing is locked onto the shaft:

- with grub (set) screws (fig. 4)
- with an eccentric locking collar (fig. 5)
- with SKF ConCentra locking technology (fig. 6)
- with an adapter sleeve (fig. 7)
- with an interference fit (fig. 8)

Insert bearings with an inner ring that is extended on both sides run more smoothly, as the extent to which the inner ring can tilt on the shaft is reduced.

The standard SKF insert bearing assortment presented in this section also includes application-specific variants, such as:

- bearings made of stainless steel or with zinc-coated rings for the food industry (*Insert bearings with grub screws*, page 342)
- bearings for agricultural applications

Fig. 3

Spherically shaped outside surface and extended inner ring

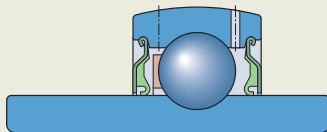

Fig. 4

Bearing locked with grub screws

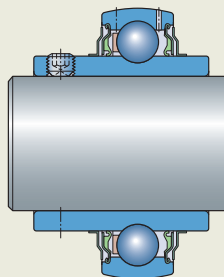

Fig. 5

Bearing locked with an eccentric locking collar

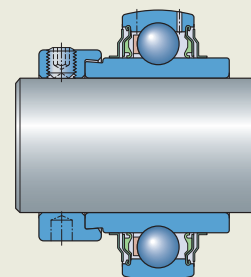

Fig. 6

Bearing locked with SKF ConCentra locking technology

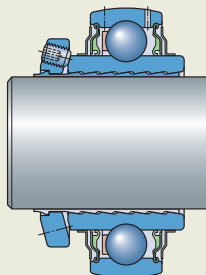

Fig. 7

Bearing locked with an adapter sleeve assembly

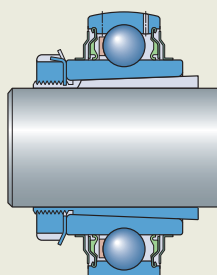
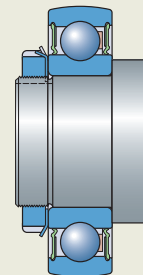

Fig. 8

Bearing locked with an interference fit and a lock nut



2 Insert bearings (Y-bearings)

Insert bearings with grub screws

- are suitable for applications for both constant and alternating directions of rotation
- are locked onto the shaft by tightening the two cup point hexagonal grub (set) screws, positioned 120° apart in the inner ring

Basic design bearings

- are available with an inner ring extended on one side (fig. 9, bearing series YAT 2)
- are available with an inner ring extended on both sides (fig. 10, bearing series YAR 2)
- are capped on both sides with:
 - a rugged standard seal (*Standard seals*, page 345) for bearing series YAT 2
 - a rugged standard seal and an additional plain sheet steel flinger (*Standard seals with additional flingers*, page 345, designation suffix 2F) or a rubberized sheet steel flinger (*Multiple seals*, page 346, designation suffix 2RF) for bearing series YAR 2
- have two lubrication holes in the outer ring as standard, one on each side, positioned 120° apart
- can be supplied without lubrication holes on request (designation suffix W)

For demanding operating conditions that occur in agricultural applications, such as combines and balers, harvesters and disk harrows, SKF has designed the YARAG 2 bearing series (fig. 11). These bearings:

- are fitted with a patented 5-lip seal (*5-lip seals*, page 346)
- are supplied without any lubrication holes in the outer ring

Bearings with zinc-coated rings

- are intended for use in corrosive environments
- are available with an inner ring extended on both sides (bearing series YAR 2..-2RF/VE495)
- have grub screws made of stainless steel
- are capped on both sides with a highly effective multiple seal (*Multiple seals*, page 346) made of food-compatible rubber with a stainless steel insert and a stainless steel flinger
- are filled with a food-grade grease
- have two lubrication holes in the outer ring, one on each side, positioned 120° apart

Stainless steel bearings

- are intended for use in corrosive environments
- are available with an inner ring extended on both sides (bearing series YAR 2..-2RF/HV)
- have all steel components made of stainless steel, including rings, balls, sheet metal parts of both seals and flingers, and grub screws
- are capped on both sides with a highly effective multiple seal (*Multiple seals*, page 346) made of food-compatible rubber with a stainless steel insert and a stainless steel flinger
- are filled with a food-grade grease
- have an annular groove with one lubrication hole in the outer ring, located on the side opposite the locking device
- have a lower dynamic load carrying capacity than same-sized bearings made of high grade carbon chromium steel

Fig. 9

Bearing in the YAT 2 series

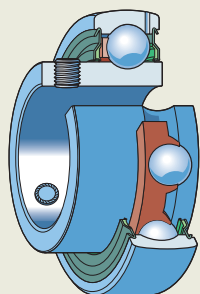

Fig. 10

Bearing in the YAR 2 series

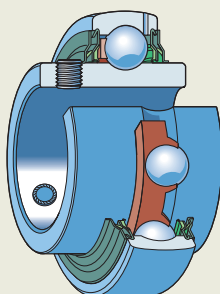
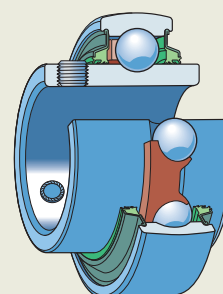

Fig. 11

Bearing in the YARAG 2 series



Insert bearings with an eccentric locking collar

- are intended for use in applications where the direction of rotation is constant
- have, on one side, an eccentric step at the extended inner ring to accommodate the locking collar, which is:
 - zinc-coated for bearings with a metric bore
 - black-oxidized for bearings with an inch bore
- are locked onto the shaft by turning the locking collar in the direction of rotation; a single grub screw further secures the collar to the shaft
- are available with an inner ring extended on one side ([fig. 12](#), bearing series YET 2)
- are available with an inner ring extended on both sides ([fig. 13](#), bearing series YEL 2)
- are capped on both sides with:
 - a rugged standard seal (*Standard seals*, [page 345](#)) for bearing series YET 2
 - a rugged standard seal and an additional plain sheet steel flinger (*Standard seals with additional flingers*, [page 345](#), designation suffix 2F) or a rubberized sheet steel flinger (*Multiple seals*, [page 346](#) designation suffix 2RF/VL065) for bearing series YEL 2
- have two lubrication holes in the outer ring as standard, one on each side, positioned 120° apart
- can be supplied without lubrication holes on request (designation suffix W)

For demanding operating conditions that occur in agricultural applications, such as combines and balers, harvesters and disk harrows, SKF has designed the YELAG 2 bearing series ([fig. 14](#)). These bearings:

- are fitted with a patented 5-lip seal (*5-lip seals*, [page 346](#))
- are supplied without any lubrication holes in the outer ring

2



Fig. 12

Bearing in the YET 2 series

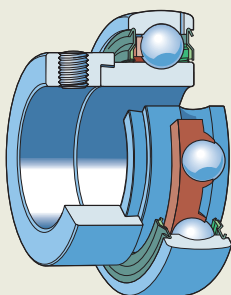

Fig. 13

Bearing in the YEL 2 series

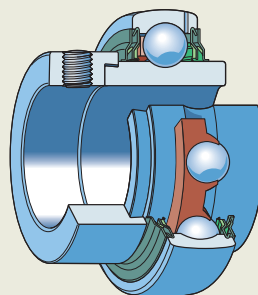
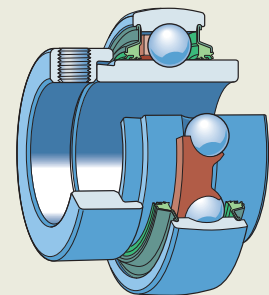

Fig. 14

Bearing in the YELAG 2 series



SKF ConCentra insert bearings

- are suitable for applications for both constant and alternating directions of rotation
- provide an easy, quick and reliable way to lock a bearing onto a shaft, even in applications where there are heavy loads and/or high speeds
- permit the full limiting speed to be achieved, even where using commercial grade shafts
- have an inner ring symmetrically extended on both sides (fig. 15, bearing series YSP 2)
- comprise the patented SKF ConCentra locking technology, which is based on the expansion and contraction of the following two mating surfaces, which have precision-engineered serrations:
 - the bearing bore
 - the external surface of the stepped sleeve
- provide a true concentric fit on the shaft, because when the grub screws in the mounting collar are tightened, the inner ring is axially displaced relative to the stepped sleeve (fig. 16), forcing the bearing inner ring to expand and the stepped sleeve to contract evenly

- provide low noise and vibration levels, and virtually eliminate fretting corrosion
- are capped on both sides with a rugged standard seal and an additional plain sheet steel flinger (*Standard seals with additional flingers*)
- have two lubrication holes in the outer ring as standard, one on each side, positioned 120° apart
- can be supplied without lubrication holes on request (designation suffix W)

For demanding operating conditions that occur in agricultural applications, such as combines and balers, harvesters and disk harrows, SKF has designed the YSPAG 2 bearing series (fig. 17). These bearings:

- are fitted with a patented 5-lip seal (*5-lip seals, page 346*)
- are supplied without any lubrication holes in the outer ring

Insert bearings with a tapered bore

- are suitable for applications for both constant and alternating directions of rotation
- fit the following adapter sleeves:
 - H 23 series for metric shafts
 - HA 23 and HE 23 series for inch shafts
- permit the full limiting speed to be achieved when mounted on an adapter sleeve, even where using commercial grade shafts
- have an inner ring symmetrically extended on both sides and a tapered bore (taper 1:12) (fig. 18, bearing series YSA 2)
- are capped on both sides with a rugged standard seal and an additional plain sheet steel flinger (*Standard seals with additional flingers*)
- have two lubrication holes in the outer ring as standard, one on each side, positioned 120° apart
- can be supplied without lubrication holes on request (designation suffix W)

The associated adapter sleeves must be ordered separately from the bearings.

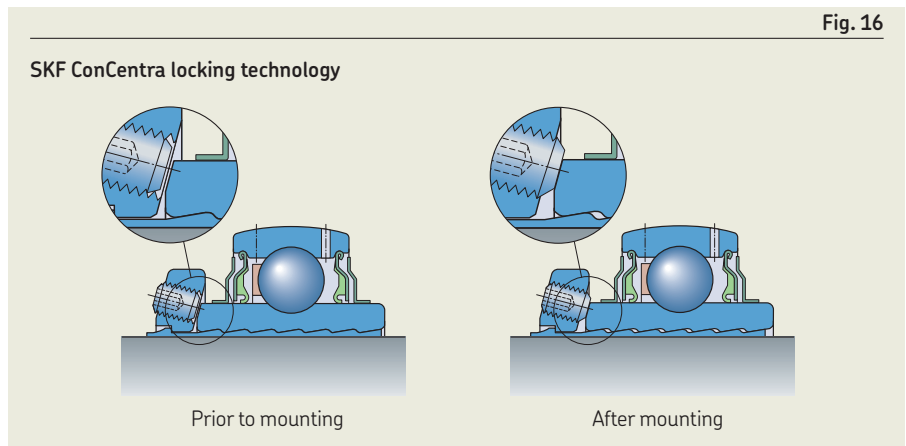

Fig. 16

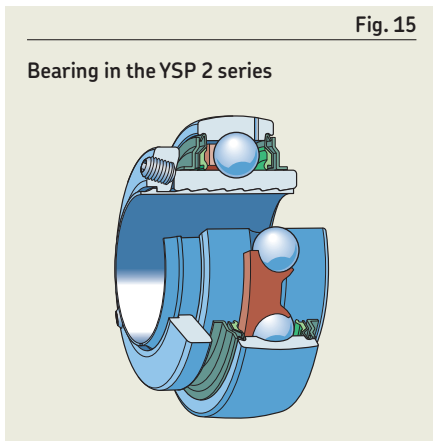

Fig. 15

Bearing in the YSP 2 series

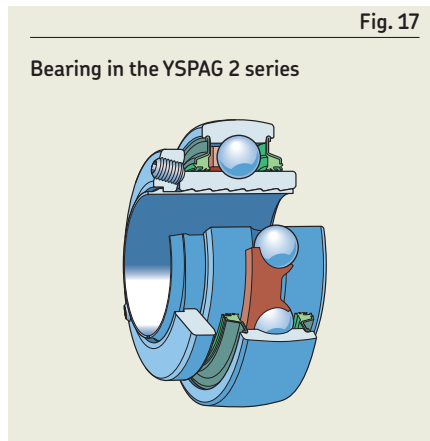

Fig. 17

Bearing in the YSPAG 2 series

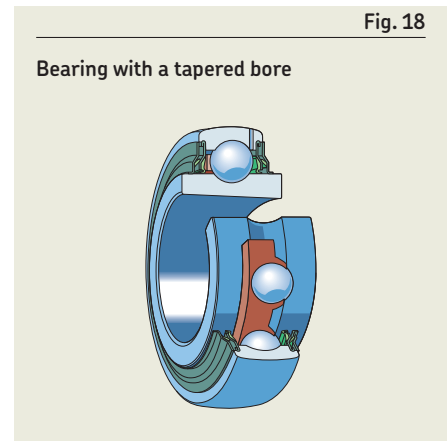

Fig. 18

Bearing with a tapered bore

Insert bearings with a standard inner ring

- are suitable for applications where smooth running is a key operational parameter
- have normal tolerances for the bearing bore diameter and are locked onto the shaft using an appropriate interference fit
- have the same dimensions and features as deep groove ball bearings in the 62 and 63 series, but have a spherically shaped (convex) outside surface (fig. 19, bearing series 17262 and 17263)
- accommodate heavier axial loads than any other insert bearing
- can operate at the same speeds as a corresponding sealed deep groove ball bearing
- are capped on both sides with:
 - an NBR contact seal (*RS1 seals*, page 346, designation suffix 2FRS1) as standard
 - a rugged standard seal (*Standard seals*, designation suffix 2FRS1/VP274)
- do not have any lubrication holes in the outer ring as standard
- can be supplied with two lubrication holes in the outer ring, one on each side, positioned 120° apart (designation suffix B)

Sealing solutions

SKF supplies all insert bearings capped with a seal or shield on both sides. In typical insert bearing applications, no additional external protection is necessary. Therefore, insert bearings are available with several sealing arrangement designs to meet the demands of a wide range of operating conditions.

When capped bearings must operate under certain conditions, such as very high speeds or high temperatures, grease may appear between the inner ring and capping device. For bearing arrangements where this would be detrimental, appropriate actions should be taken.

Standard seals

- consist of a stamped sheet steel washer with a seal lip made of NBR, vulcanized to its inner surface (fig. 20, designation suffix VP274 for bearings with a standard inner ring and no designation suffix for other insert bearings)
- form, with its non-contact sheet steel washer, a narrow gap with the inner ring shoulder to protect the seal against coarse contaminants

Standard seals with additional flingers

- are recommended for the more contaminated environments
- consist of a standard seal and an additional sheet steel or stainless sheet steel plain flinger (fig. 21, designation suffix 2F)
- have an interference fit for the flinger on the inner ring shoulder to improve considerably the effectiveness of the seal without increasing friction
- are only available for bearings with an inner ring extended on both sides

Fig. 19

Bearing with a standard inner ring

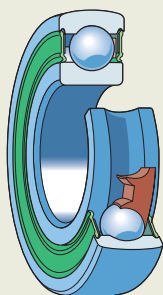

Fig. 20

Standard seals

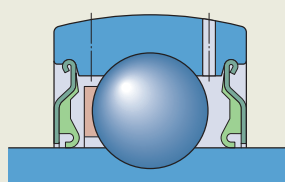
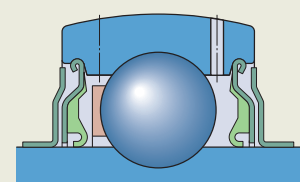

Fig. 21

Standard seals with additional flinger



2 Insert bearings (Y-bearings)

Multiple seals

- are recommended for very contaminated environments
- consist of a standard seal and a flinger with a vulcanized NBR lip, which seals axially against the standard seal (fig. 22, designation suffix 2RF)
- have the space between the flinger lip and the inner ring shoulder filled with grease to provide additional protection
- are only available for bearings with an inner ring extended on both sides

5-lip seals

- are recommended for extremely contaminated environments, such as agricultural applications
- are patented by SKF
- consist of a sheet steel insert with a vulcanized 5-lip contact seal made of a low-friction NBR compound (fig. 23):

- The steel insert is held in place by a groove in the bearing outer ring and protects the seal from solid contaminants.
 - Each seal lip has a different design to provide superior sealing performance in response to different operating conditions, including dynamic misalignment.
 - The outermost and innermost lips act as a labyrinth to prevent contaminant ingress and grease leakage, respectively.
 - The three inner lips make constant contact with the inner ring shoulder.
- are only available for bearings with an inner ring extended on both sides

RS1 seals

- were originally developed for standard SKF deep groove ball bearings
- are fitted in a recess on the outer ring and ride against the inner ring shoulder to act as contact seals (fig. 24, designation suffix 2RS1)
- are made of sheet steel reinforced NBR

Shields

- are designed for applications where the contamination level is low and additional friction should be avoided
- are fitted in a recess on the outer ring (fig. 25, designation suffix VP076)
- do not make contact with the inner ring, but form a narrow gap
- are made of sheet steel
- are only available for insert bearings on request

Bearings with shields should not be used where water, steam or moisture can enter the bearing.

Fig. 22

Multiple seals

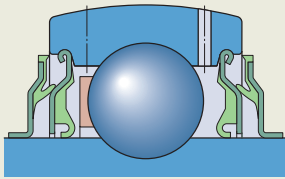

Fig. 23

5-lip seals

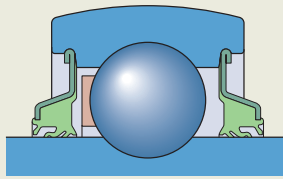

Fig. 24

RS1 seals

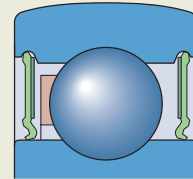

Fig. 25

Shields

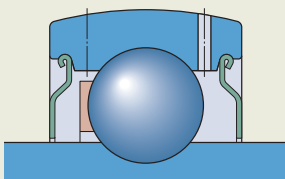

Fig. 26

Snap-type, glass fibre reinforced PA66 cage

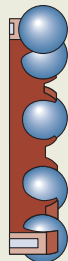

Fig. 27

Rubber seating rings in the RIS 2 series



Cages

SKF insert bearings are fitted as standard with a snap-type, glass fibre reinforced PA66 cage (fig. 26), no designation suffix.

When used at high temperatures, some lubricants can have a detrimental effect on polyamide cages. For additional information about the suitability of cages, refer to *Cages*, page 187.

- are intended to dampen vibration and noise
- are intended to enable the bearings to be displaced slightly in their housings to accommodate minor shaft expansion or misalignment
- are located on the bearing outer ring and in the housing bore (fig. 28)
- are made of NBR
- can withstand temperatures ranging from -30 to $+100$ °C (-20 to $+210$ °F)

Rubber seating rings

- are available in the RIS 2 series (fig. 27, table 1)
- can be fitted on all SKF insert bearings, except for those with a standard inner ring (17262 and 17263 series)
- are primarily intended to “cushion” insert bearings in pressed steel plummer block housings

Rubber seating rings are available as an accessory and must be ordered separately. However, insert bearings in the YET 2 series can be supplied with the seating ring already fitted (fig. 29). These products are identified by the series prefix CYS, followed by the bearing bore diameter and the bearing identification suffix FM, e.g. CYS 20 FM is a YET 204 bearing with a 20 mm bore, fitted with an RIS 204 rubber seating ring.

Table 1

Rubber seating rings

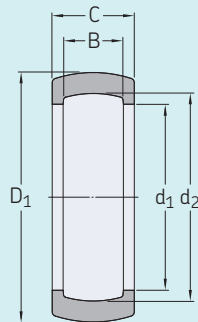

Insert bearing Outside diameter D	Size	Rubber seating ring Designation	Rubber seating ring Dimensions					Mass
			D ₁	d ₁	d ₂	B	C	
mm	–	–	mm					g
40	03	RIS 203	47,3	35,5	39,8	12	18	12
47	04	RIS 204	52,3	41,2	46,8	14	19	11,5
52	05	RIS 205	62,3	46,4	51,8	15	20,5	26,5
62	06	RIS 206 A	72,3	54,6	61,8	18	21,5	31
72	07	RIS 207 A	80,3	63,7	71,8	19	23	32
80	08	RIS 208 A	85,3	70,7	79,7	21	24	26

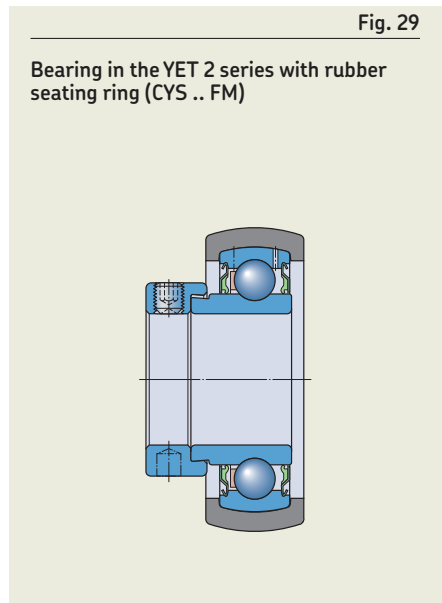
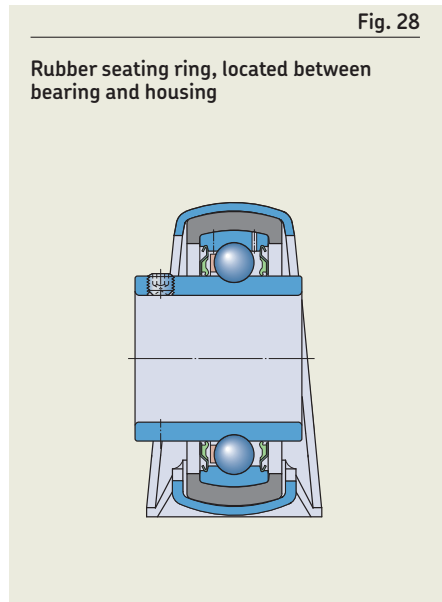

Lubrication

SKF insert bearings are supplied capped on both sides and are greased.

Greases for capped bearings

Insert bearings are filled with one of the following greases (table 2):

- zinc-coated and stainless steel insert bearings
→ food-grade grease GFJ, registered by NSF as category H1

The NSF registration confirms the grease fulfils the requirements listed in the US Food and Drug Administration's guidelines under 21 CFR section 178.3570 (lubricant acceptable with incidental food contact, for use in and around food processing areas).

- all other insert bearings
→ standard grease VT307

Grease life for insert bearings

- is presented as L_{10} , i.e. the time period at the end of which 90% of the bearings are still reliably lubricated
- depends on the load, operating temperature and the nd_m value (diagram 1)

The indicated grease life is valid for the following combination of operating conditions:

- horizontal shaft
- very light to moderate loads ($P \leq 0,05 C$)
- stationary machine
- low vibration levels

Where the operating conditions vary, the grease life obtained from the diagram should be adjusted as follows:

- vertical shafts → 50% of the obtained value
- heavier loads ($P > 0,05 C$) → apply reduction factor (table 4)

The values for adjusting the grease life are estimates. Vibration can have a negative influence on grease life. The extent cannot be quantified, and the influence increases with increasing operating temperature.

Relubrication

Insert bearings do not need relubrication if the grease life exceeds the *SKF rating life*, page 89 of the bearing.

Relubrication can extend bearing service life under any of the following conditions:

- The bearings are exposed to high humidity or severe contamination.
- The bearings accommodate normal or heavy loads.
- The bearings operate for extended periods at high speeds or at temperatures above 55 °C (130 °F).
- The bearings are subjected to high vibration levels.

To relubricate insert bearings, the following greases can be used:

- zinc-coated and stainless steel insert bearings
→ food-grade grease SKF LGFP 2
- all other insert bearings
→ SKF LGWA 2, LGMT 2 or LGMT 3 grease

Table 2

Technical specifications of SKF greases for insert bearings

Grease	Temperature range ¹⁾		Thickener	Base oil type	NLGI grade	Base oil viscosity [mm ² /s]	
	°C	°F				at 40 °C (105 °F)	at 100 °C (210 °F)
VT307	-50	250	Lithium-calcium soap	Mineral	2	190	15
GFJ	-60	480	Aluminium-complex soap	Synthetic hydrocarbon	2	100	14

¹⁾ Refer to the SKF traffic light concept (page 117).

If relubrication is needed, the relubrication intervals can be estimated by following the method explained under *Estimating the relubrication interval for grease*, page 111.

When relubricating, the shaft should be turned and the grease pumped slowly until fresh grease starts to escape from the seal(s). Excessive pressure from pumping too quickly can damage the seals. When machines and equipment are used for a limited period of time, SKF recommends relubricating each bearing at the end of the operational period, i.e. immediately before being laid up.

Relubrication features

SKF insert bearings are designed to facilitate relubrication. They have two lubrication holes in the outer ring as standard, one on each side, positioned 120° apart. Bearings without lubrication holes can be supplied on request (designation suffix W).

The following bearings do not have the standard relubrication features:

- Stainless steel insert bearings with grub screws have a lubrication groove in the outer ring located on the side opposite the locking device and one lubrication hole within this groove.
- Insert bearings with a standard inner ring without designation suffix B and insert bearings with 5-lip seals are lubricated for life and cannot be relubricated. They do not have any lubrication holes.

Table 3

Bearing mean diameter d_m

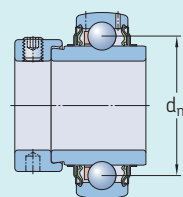

Bearing size ¹⁾	Bearing mean diameter d_m mm
–	mm
03	28,5
04	33,5
05	39
06	46
07	53,5
08	60
09	65
10	70
11	77,5
12	85
13	92,5
14	97,5
15	102,5
16	110
17	117,5
18	126
20	141

¹⁾ For example, bearing size 06 includes all bearings based on a 206 insert bearing, such as YAR 206-2F, YAR 206-101-2F, YAR 206-102-2F, YAR 206-103-2F, YAR 206-104-2F.

Diagram 1

Grease life for insert bearings with VT307 or GFJ grease where $P = 0,05 C$

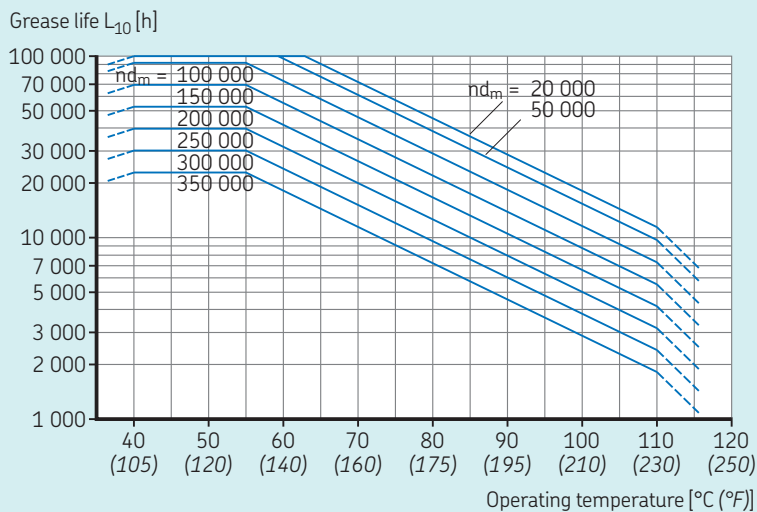

n = rotational speed [r/min]
 d_m = mean diameter [mm] (table 3)

Table 4

Reduction factor for the grease life, depending on the load

Load P	Reduction factor
$\leq 0,05 C$	1
0,1 C	0,7
0,125 C	0,5
0,25 C	0,2

Bearing data, continued

**Permissible
misalignment****Static misalignment**

Insert bearings can accommodate static initial misalignment by tilting in the housing ([fig. 2, page 340](#)). The permissible values are:

- SKF housings
 - relubrication is not required: 5°
 - relubrication is required (where applicable): 2°
- SKF pressed steel housings
 - Misalignment cannot be accommodated once the attachment bolts have been fully tightened, unless a rubber seating ring is used ([page 347](#)).

Dynamic misalignment

Insert bearings can accommodate a few minutes of arc (misalignment) between the inner and outer rings.



Table 5

Tolerances for SKF insert bearings

Nominal diameter		Inner ring Bearing series YAT 2, YAR 2, YARAG 2, YET 2, YEL 2, YELAG 2		Outer ring All bearings	
d, D		Δ_{dmp}	L	Δ_{Dmp}	L
>	≤	U		U	
mm		μm		μm	
10	18	+15	+5	–	–
18	31,75	+18	+5	–	–
31,75	50,8	+19	+5	0	–10
50,8	80,962	+21	+5	0	–10
80,962	120	+25	+5	0	–15
120	150	–	–	0	–15
150	180	–	–	0	–20

d = nominal bore diameter
D = nominal outside diameter

Table 6

Radial internal clearance for insert bearings

Bearing size ¹⁾	Radial internal clearance of insert bearings in the series			
	YAT 2, YAR 2, YARAG 2, YET 2, YEL 2, YELAG 2		YSP 2, YSPAG 2, YSA 2	
	min.	max.	min.	max.
–	μm			
03	10	25	–	–
04	12	28	–	–
05-06	12	28	23	41
07-08	13	33	28	46
09-10	14	36	30	51
11-13	18	43	38	61
14-16	20	51	–	–
17-20	24	58	–	–

¹⁾ For example, bearing size 06 includes all bearings based on a 206 insert bearing, such as YAR 206-2F, YAR 206-101-2F, YAR 206-102-2F, YAR 206-103-2F, YAR 206-104-2F.

Loads

<p>Minimum load</p> <p>For additional information → page 111</p>	<p>$F_{rm} = 0,01 C$</p> <p>The importance of imposing a minimum load increases where accelerations in the bearing are rapid, and where speeds are in the region of 75% or more of the limiting speed quoted in the product tables.</p>	<p>Symbols</p> <p>C basic dynamic load rating [kN] (product tables, page 366)</p> <p>C_0 basic static load rating [kN] (product tables)</p> <p>e limiting value (table 7, page 354)</p> <p>f_0 calculation factor (table 8, page 354)</p> <p>F_a axial load [kN]</p> <p>F_r radial load [kN]</p> <p>F_{rm} minimum radial load [kN]</p> <p>P equivalent dynamic bearing load [kN]</p> <p>P_0 equivalent static bearing load [kN]</p> <p>X radial load factor (table 7)</p> <p>Y axial load factor (table 7)</p>
<p>Axial load carrying capacity</p>	<p>$F_a \leq 0,25 C_0$</p> <p>The maximal permissible axial load of any locking mechanism is always $> 0,25 C_0$.</p>	
<p>Equivalent dynamic bearing load</p> <p>For additional information → page 96</p>	<p>$F_a/F_r \leq e \rightarrow P = F_r$ $F_a/F_r > e \rightarrow P = X F_r + Y F_a$</p>	
<p>Equivalent static bearing load</p> <p>For additional information → page 110</p>	<p>$P_0 = 0,6 F_r + 0,5 F_a$</p>	

Table 7

Calculation factors

$f_0 F_a / C_0$	Bearing series			17262, 17263		
	e	X	Y	e	X	Y
0,172	0,29	0,46	1,88	0,19	0,56	2,3
0,345	0,32	0,46	1,71	0,22	0,56	1,99
0,689	0,36	0,46	1,52	0,26	0,56	1,71
1,03	0,38	0,46	1,41	0,28	0,56	1,55
1,38	0,4	0,46	1,34	0,3	0,56	1,45
2,07	0,44	0,46	1,23	0,34	0,56	1,31
3,45	0,49	0,46	1,1	0,38	0,56	1,15
5,17	0,54	0,46	1,01	0,42	0,56	1,04
6,89	0,54	0,46	1	0,44	0,56	1

Table 8

Calculation factor f_0

Bearing series sizes	Factor f_0
YAT 2, YAR 2, YARAG 2, YET 2, YEL 2, YELAG 2, YSP 2, YSPAG 2, YSA 2	
03-04	13
05-12	14
13-18	15
20	14
17262	
03-04	13
05-12	14
17263	
05	12
06-10	13

Temperature limits

The permissible operating temperature for insert bearings can be limited by:

- the dimensional stability of the bearing rings and balls
- the cage
- the seals
- the lubricant

Where temperatures outside the permissible range are expected, contact SKF.

Bearing rings and balls

SKF insert bearings are heat stabilized up to at least 150 °C (300 °F).

Cages

For temperature limits of PA66 cages, refer to *Polymer cages*, [page 188](#).

Seals

The permissible operating temperature for NBR seals is -40 to +100 °C (-40 to +210 °F). Temperatures up to 120 °C (250 °F) can be tolerated for brief periods.

Typically, temperature peaks are at the seal lip.

Lubricants

Temperature limits for the greases used in SKF insert bearings are provided in [table 2](#), [page 348](#). For temperature limits of other SKF greases, refer to *Selecting a suitable SKF grease*, [page 116](#).

When using lubricants not supplied by SKF, temperature limits should be evaluated according to the SKF traffic light concept ([page 117](#)).

Permissible speed

Insert bearings should not operate at speeds above the limiting speed listed in the [product tables](#), [page 366](#). This speed limit is set by the seal design.

For insert bearings with grub screws or an eccentric locking collar, the permissible speed is also influenced by the shaft tolerance.

Where using these bearings on shafts with tolerances other than h6, compare the speed values listed in the product tables with those in [table 9](#). The lower value is the permissible speed.

The permissible speed of insert bearings with 5-lip seals is valid under the following conditions:

- outer ring temperature ≤ 60 °C (140 °F)
- ambient temperature ≤ 25 °C (80 °F)
- very light to moderate loads ($P \leq 0,05 C$)
- cast iron housing

For other conditions, contact SKF.

For applications operating at elevated speeds or where low vibration levels or quiet running is required, SKF recommends the use of either SKF ConCentra insert bearings, insert bearings on an adapter sleeve or insert bearings with a standard inner ring.

Table 9

Permissible speeds for insert bearings with grub screws or an eccentric locking collar

Bearing size ¹⁾	Permissible speed for shafts machined to tolerance class			
	h7 \oplus	h8 \oplus	h9 \oplus	h11 \oplus
–	r/min			
03	6 000	4 300	1 500	950
04	5 300	3 800	1 300	850
05	4 500	3 200	1 000	700
06	4 000	2 800	900	630
07	3 400	2 200	750	530
08	3 000	1 900	670	480
09	2 600	1 700	600	430
10	2 400	1 600	560	400
11	2 000	1 400	500	360
12	1 900	1 300	480	340
13	1 700	1 100	430	300
14	1 600	1 000	400	280
15	1 500	950	380	260
16	1 400	900	360	240
17	1 300	850	340	220
18	1 200	800	320	200
20	1 100	750	300	190

¹⁾ For example, bearing size 06 includes all bearings based on a 206 insert bearing, such as YAR 206-2F, YAR 206-101-2F, YAR 206-102-2F, YAR 206-103-2F, YAR 206-104-2F.

Design considerations



Axial displacement

Insert bearings are not intended to accommodate axial displacement of the shaft relative to the housing. The distance between bearing positions should therefore be short to avoid excessive induced axial loads as a result of thermal expansion of the shaft.

Design for small axial displacement

To accommodate small axial displacement, the bearings should be supported by resilient sheet metal support surfaces or walls (fig. 30).

Design for larger axial displacement

In applications where there are low speeds and light loads, an insert bearing with grub screws can be used to accommodate axial displacement. The shaft at the non-locating bearing position should be provided with one or two grooves, 120° apart, to engage a modified grub screw:

- Hexagon socket grub (set) screws with a dog point, in accordance with ISO 4028, but with a fine thread according to table 10. The grub screw should be secured by a nut and a spring or star lock washer (fig. 31).

The screws and groove(s) accommodate changes in shaft length and prevent the shaft from turning independently of the bearing. The sliding surfaces between the shaft and inner ring and those in the shaft grooves should be coated with a lubricant paste.

Fig. 30

Design for small axial displacement

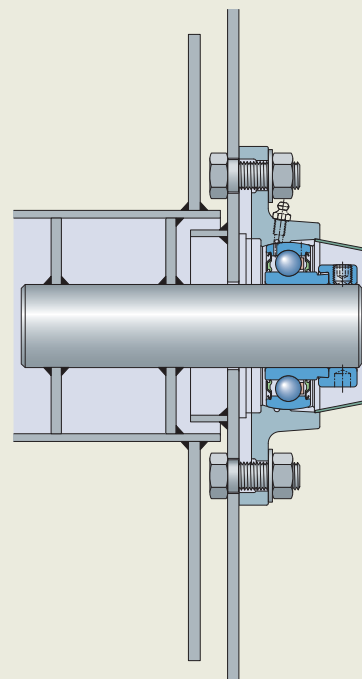

Fig. 31

Hexagon socket grub screw with a dog point secured by a nut and a star lock washer

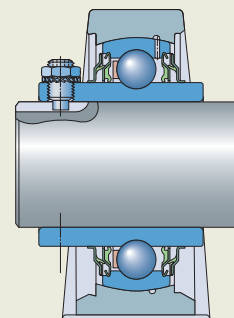
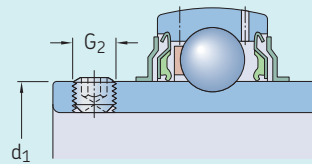

Table 10

Threaded holes in the inner ring of bearings in the YAT 2, YAR 2 and YARAG 2 series



Bearing size ¹⁾	Outside diameter of inner ring	Threaded holes			
	d_1	YAR bearing with metric bore G_2	YAR bearing with inch bore G_2	YAT bearing with metric bore G_2	YAT bearing with inch bore G_2
–	mm	–	–	–	–
03	24,2	M 6x0,75	#10-32 UNF	M 6x0,75	#10-32 UNF
04	28,2	M 6x0,75	1/4-28 UNF	M 6x0,75	1/4-28 UNF
05	33,7	M 6x0,75	1/4-28 UNF	M 6x0,75	1/4-28 UNF
06	39,7	M 6x0,75	1/4-28 UNF	M 6x0,75	5/16-24 UNF
07	46,1	M 6x0,75	5/16-24 UNF	M 6x0,75	5/16-24 UNF
08	51,8	M 8x1	5/16-24 UNF	M 6x0,75	5/16-24 UNF
09	56,8	M 8x1	5/16-24 UNF	M 6x0,75	5/16-24 UNF
10	62,5	M 10x1	3/8-24 UNF	M 8x1	3/8-24 UNF
11	69,1	M 10x1	3/8-24 UNF	–	3/8-24 UNF
12	75,6	M 10x1	3/8-24 UNF	–	3/8-24 UNF
13	82,5	M 10x1	3/8-24 UNF	–	–
14	87	M 10x1	7/16-20 UNF	–	–
15	92	M 10x1	7/16-20 UNF	–	3/8-24 UNF
16	97,4	M 10x1	7/16-20 UNF	–	3/8-24 UNF
17	105	M 12x1,5	–	–	–
18	112,5	M 12x1,5	–	–	–
20	124,8	M 12x1,5	–	–	–

¹⁾ For example, bearing size 06 includes all bearings based on a 206 insert bearing, such as YAR 206-2F, YAR 206-101-2F, YAR 206-102-2F, YAR 206-103-2F, YAR 206-104-2F.

Shaft tolerances

Recommended seat tolerances for insert bearings are listed in [table 11](#). The relative position of the upper and lower limits of the most commonly used ISO shaft tolerance classes for insert bearings, except for those with a standard inner ring, is illustrated in [fig. 32](#). The values for these tolerance classes are listed in [table 12](#).

Insert bearings on an adapter sleeve or SKF ConCentra insert bearings

The shaft seat total radial run-out should be IT5/2 for ISO tolerance class h9 \oplus ([table 12](#)).

Insert bearings with a standard inner ring

The same recommendations apply as for standard deep groove ball bearings ([table 11](#)). The values for these ISO tolerance classes are listed in [table 12](#), [page 156](#), and [table 14](#), [page 160](#).

Table 11

Recommended shaft seat tolerances

Operating conditions	Tolerance class ¹⁾
Insert bearings with grub screws or an eccentric locking collar P > 0,05 C and/or high speeds	h6
0,035 C < P ≤ 0,05 C	h7
0,02 C < P ≤ 0,035 C and/or low speeds	h8
Simple bearing arrangements or P ≤ 0,02 C	h9 – h11
Insert bearings with a tapered bore on an adapter sleeve or SKF ConCentra insert bearings All loads and speeds	h9/IT5
Insert bearings with a standard inner ring P > 0,035 C Shaft diameter ≤ 17 mm Shaft diameter ≥ 20 mm	j5 k5
P ≤ 0,035 C Shaft diameter ≥ 20 mm	j6

¹⁾ The envelope requirement (symbol \oplus from ISO 14405-1) is not shown but applies to all tolerance classes.

Fig. 32

Recommended fits

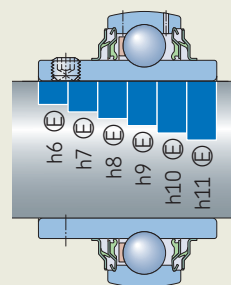

Mounting and dismounting

When mounting insert bearings on a shaft, suitable tools should be used and the locking components should be tightened to the torque values / tightening angles listed in:

- [table 13, page 360](#), for bearings with grub screws and bearings with an eccentric locking collar
- [table 14, page 361](#), for bearings on an adapter sleeve
- [table 15, page 362](#), for SKF ConCentra bearings

For additional information about mounting and dismounting insert bearings and assembling ball bearing units, refer to the *SKF bearing maintenance handbook*.

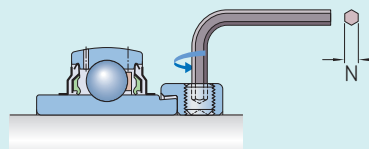
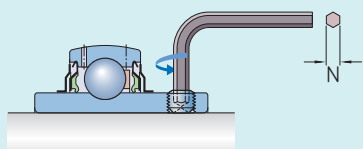

Table 12

ISO shaft deviations for insert bearings, except for those with a standard inner ring

Shaft diameter d		Shaft diameter deviations											
		Tolerance class h6 [Ⓔ]		h7 [Ⓔ]		h8 [Ⓔ]		h9 [Ⓔ]		h10 [Ⓔ]		h11 [Ⓔ]	
>	≤	Deviation		U	L	U	L	U	L	U	L	U	L
mm		μm											
10	18	0	-11	0	-18	0	-27	0	-43	0	-70	0	-110
18	30	0	-13	0	-21	0	-33	0	-52	0	-84	0	-130
30	50	0	-16	0	-25	0	-39	0	-62	0	-100	0	-160
50	80	0	-19	0	-30	0	-46	0	-74	0	-120	0	-190
80	120	0	-22	0	-35	0	-54	0	-87	0	-140	0	-220

Grub screws in inner rings and eccentric locking collars – key sizes and recommended tightening torques



Bearing size ¹⁾	Bearing with metric bore		Bearing with inch bore	
	Hexagonal key size N	Tightening torque	Hexagonal key size N	Tightening torque
–	mm	Nm	in.	Nm

Bearing size ¹⁾	Bearing with metric bore		Bearing with inch bore	
	Hexagonal key size N	Tightening torque	Hexagonal key size N	Tightening torque
–	mm	Nm	in.	Nm

Bearings in the YAR 2 or YARAG 2 series

03	3	4	3/32	4
04	3	4	1/8	4
05	3	4	1/8	4
06	3	4	1/8	4
07	3	4	5/32	6,5
08	4	6,5	5/32	6,5
09	4	6,5	5/32	6,5
10	5	16,5	3/16	16,5
11	5	16,5	3/16	16,5
12	5	16,5	3/16	16,5
13	5	16,5	3/16	16,5
14	5	16,5	7/32	28,5
15	5	16,5	7/32	28,5
16	5	16,5	7/32	28,5
17	6	28,5	–	–
18	6	28,5	–	–
20	6	28,5	–	–

Bearings in the YAT 2 series

03	3	4	3/32	4
04	3	4	1/8	4
05	3	4	1/8	4
06	3	4	5/32	6,5
07	3	4	5/32	6,5
08	3	4	5/32	6,5
09	3	4	5/32	6,5
10	4	6,5	5/32	6,5
11	–	–	3/16	16,5
12	–	–	3/16	16,5
15	–	–	3/16	16,5
16	–	–	3/16	16,5

Bearings in the YET 2, YEL 2 or YELAG 2 series

03	3	4	1/8	4
04	3	4	1/8	4
05	3	4	1/8	4
06	4	6,5	5/32	6,5
07	5	16,5	3/16	16,5
08	5	16,5	3/16	16,5
09	5	16,5	3/16	16,5
10	5	16,5	3/16	16,5
11	5	16,5	7/32	28,5
12	5	16,5	7/32	28,5

¹⁾ For example, bearing size 06 includes all bearings based on a 206 insert bearing, such as YAR 206-2F, YAR 206-101-2F, YAR 206-102-2F, YAR 206-103-2F, YAR 206-104-2F.

Table 14

Hook spanners for insert bearings on an adapter sleeve – sizes and recommended tightening angles

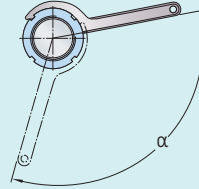

Designation	Shaft diameter		Hook spanner	Lock nut tightening angle ¹⁾
Insert bearing + adapter sleeve	d			α
–	mm	in.	–	°
YSA 205-2FK + HE 2305	–	3/4	HN 5	90
YSA 205-2FK + H 2305	20	–	HN 5	90
YSA 206-2FK + HA 2306	–	15/16	HN 6	95
YSA 206-2FK + H 2306	25	–	HN 6	95
YSA 206-2FK + HE 2306	–	1	HN 6	95
YSA 207-2FK + H 2307	30	–	HN 7	100
YSA 207-2FK + HA 2307	–	1 3/16	HN 7	100
YSA 208-2FK + HE 2308	–	1 1/4	HN 8	105
YSA 208-2FK + H 2308	35	–	HN 8	105
YSA 209-2FK + HA 2309	–	1 7/16	HN 9	110
YSA 209-2FK + HE 2309	–	1 1/2	HN 9	110
YSA 209-2FK + H 2309	40	–	HN 9	110
YSA 210-2FK + HA 2310	–	1 11/16	HN 10	115
YSA 210-2FK + HE 2310	–	1 3/4	HN 10	115
YSA 210-2FK + H 2310	45	–	HN 10	115
YSA 211-2FK + HA 2311	–	1 15/16	HN 11	90
YSA 211-2FK + H 2311	50	–	HN 11	90
YSA 211-2FK + HE 2311 B	–	2	HN 11	90
YSA 212-2FK + H 2312	55	–	HN 12	95
YSA 213-2FK + HA 2313	–	2 3/16	HN 13	100
YSA 213-2FK + HE 2313	–	2 1/4	HN 13	100
YSA 213-2FK + H 2313	60	–	HN 13	100

¹⁾ The listed values are to be used as guideline values only, as it is difficult to establish an exact starting position.

Table 15

Grub screws in SKF ConCentra insert bearings – key sizes and recommended tightening torques

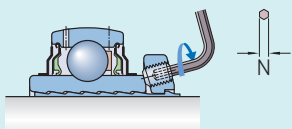

Bearing size ¹⁾		Screw size	Hexagonal key size N	Tightening torque
≥	≤			
–	–	–	mm	Nm
05	06	M5	2,5	4,2
07	13	M6	3	7,4

¹⁾ For example, bearing size 07 includes all bearings based on a 207 insert bearing, such as YSP 207 SB-2F, YSP 207-104 SB-2F, YSP 207-106 SB-2F, YSP 207-107 SB-2F.

Assembling insert bearings into housings with fitting slots

When mounting an insert bearing into a housing with fitting slots, the bearing should be inserted into the fitting slot in the housing bore (fig. 33) and then swivelled into position. The misalignment of the bearing relative to the housing should not exceed 5°. Eccentric locking collars should be removed from the bearing prior to mounting and reinstalled when the bearing is in position in the housing.

The locking device should face in the same direction as the fitting slots, except for stainless steel housings and composite housings for SKF Food Line with designation suffix L. Where mounting bearings into these housings, the locking device should face in the opposite direction to the fitting slots.

Make sure that no relubrication hole or groove in the bearing outside diameter coincides with either of the fitting slots in the housing, otherwise grease leakage may result or contamination might enter the bearing (fig. 34).

If the bearing has to be relubricated, make sure the relubrication features in the outer ring (hole, or groove and hole) coincide with the relubrication feature in the housing bore. The misalignment of the bearing relative to the housing should not exceed 2°, otherwise relubrication will not be possible (fig. 35).

SKF recommends mounting SKF insert bearings only into SKF housings to avoid a mismatch of components and to enable proper bearing relubrication.

Fig. 33

Assembling a bearing into a housing with fitting slots

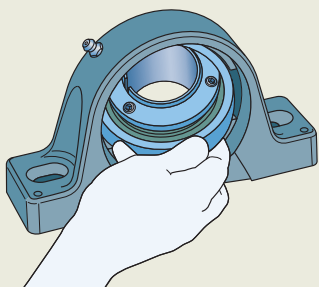
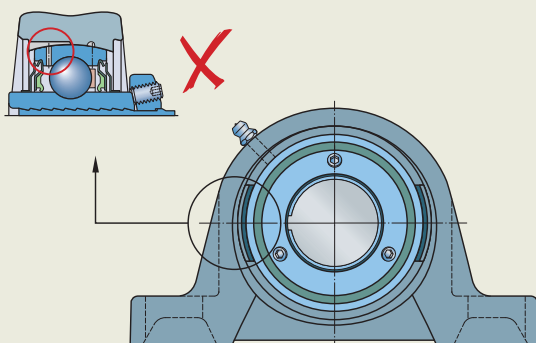

Fig. 34

Relubrication hole or groove not to coincide with fitting slots



SKF ConCentra insert bearings

When mounting SKF ConCentra insert bearings, position the collar so that one grub screw is directly opposite the slit in the sleeve.

CAUTION: Do not tighten the grub (set) screws until the bearing is positioned on the shaft. If the screws are tightened prematurely, the stepped sleeve may deform. No attempt should be made to remove the sleeve and the mounting collar from the bearing prior to mounting.

To dismount SKF ConCentra insert bearings, loosen the grub screws first. Then gently tap the edge of the sleeve on the collar side or the inner ring side face on the opposite side to loosen the lock (fig. 36).

Fig. 35

Misalignment $\leq 2^\circ$ where relubrication is required

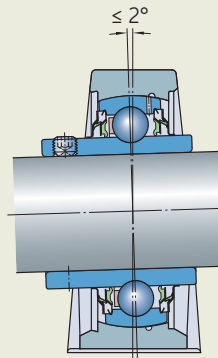
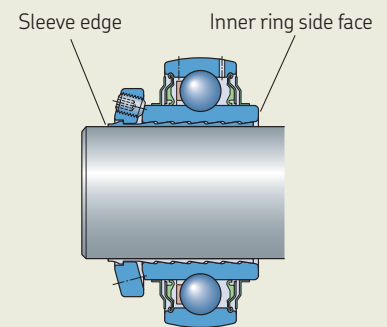

Fig. 36

Dismounting an SKF ConCentra insert bearing



Designation system



Prefixes

Basic designation

Bearing design

- YAR** Bearing with grub screws, inner ring extended on both sides
- YARAG** Bearing with grub screws, inner ring extended on both sides, 5-lip seals, without lubrication holes
- YAT** Bearing with grub screws, inner ring extended on one side
- YEL** Bearing with an eccentric locking collar, inner ring extended on both sides
- YELAG** Bearing with an eccentric locking collar, inner ring extended on both sides, 5-lip seals, without lubrication holes
- YET** Bearing with an eccentric locking collar, inner ring extended on one side
- YSA** Bearing with a tapered bore, inner ring symmetrically extended on both sides
- YSP** Bearing with SKF ConCentra locking technology, inner ring symmetrically extended on both sides
- YSPAG** Bearing with SKF ConCentra locking technology, inner ring symmetrically extended on both sides, 5-lip seals, without lubrication holes
- 172** Bearing with a standard inner ring
- CYS** Bearing in the YET 2 series fitted with a rubber seating ring

Dimension series

- 2** Outside diameter to ISO 15, diameter series 2
- 62** Bearing in accordance with ISO 15, dimension series 02, spherically shaped outside surface
- 63** Bearing in accordance with ISO 15, dimension series 03, spherically shaped outside surface

Bore diameter d

Bearings for metric shafts

- 03/12** 12 mm
- 03/15** 15 mm
- 03** 17 mm
- 04** 20 mm
- to
- 20** 100 mm

Bearings for inch shafts

Three-digits combination that follows the designation of the basic metric bearing and is separated from this by a hyphen: the first digit is the number of whole inches and the second and third digits are the number of sixteenths of an inch, e.g. 204-012

- 008** 1/2 in. (12,7 mm)
- to
- 300** 3 in. (76,2 mm)

Suffixes

Group 1: Internal design

- B** Lubrication holes in the outer ring (only for bearings with a standard inner ring)
- SB** SKF ConCentra ball bearing with shortened inner ring

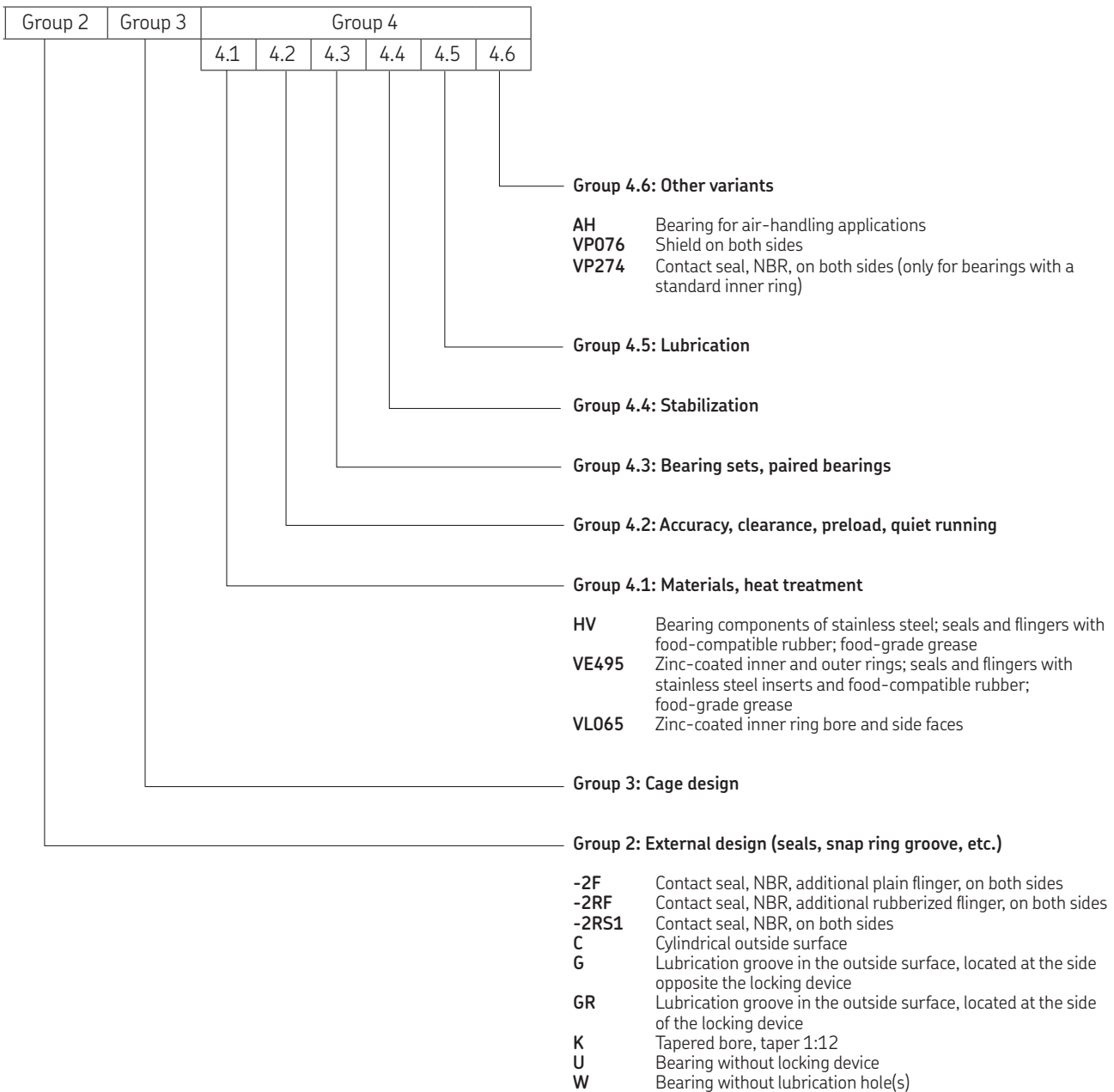

2.1 Insert bearings with grub screws, metric shafts

d 12 – 100 mm

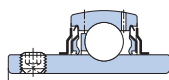
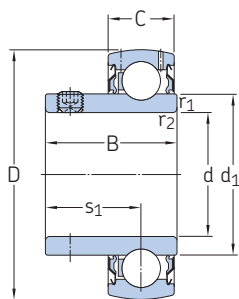

YAR...-2F

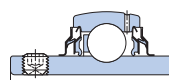

YAR...-2RF/HV

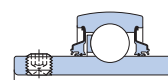

YARAG

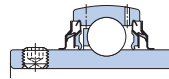

YAR...-2RF

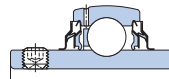

YAR...-2RFGR/HV

YAT

Dimensions							Basic load ratings		Fatigue load limit	Limiting speed with shaft tolerance h6	Mass	Designation	
d	D	B	C	d ₁	s ₁	r _{1,2} min.	C	C ₀					
mm							kN	kN	r/min	kg	–		
12	40	27,4	12	24,2	15,9	0,3	9,56	4,75	0,2	9 500	0,12	► YAR 203/12-2F	
15	40	27,4	12	24,2	15,9	0,3	9,56	4,75	0,2	9 500	0,11	► YAR 203/15-2F	
17	40	22,1	12	24,2	15,9	0,3	9,56	4,75	0,2	9 500	0,08	► YAT 203	
	40	27,4	12	24,2	15,9	0,3	9,56	4,75	0,2	9 500	0,1	► YAR 203-2F	
20	47	25,5	14	28,2	18,3	0,6	12,7	6,55	0,28	8 500	0,13	► YAT 204	
	47	31	14	28,2	18,3	0,6	10,8	6,55	0,28	5 000	0,15	► YAR 204-2RF/HV	
	47	31	14	28,2	18,3	0,6	10,8	6,55	0,28	5 000	0,15	► YAR 204-2RFGR/HV	
20	47	31	14	28,2	18,3	0,6	12,7	6,55	0,28	1 800	0,15	YARAG 204	
	47	31	14	28,2	18,3	0,6	12,7	6,55	0,28	5 000	0,15	► YAR 204-2RF	
	47	31	14	28,2	18,3	0,6	12,7	6,55	0,28	5 000	0,15	► YAR 204-2RF/VE495	
	47	31	14	28,2	18,3	0,6	12,7	6,55	0,28	8 500	0,15	► YAR 204-2F	
	25	52	27,2	15	33,7	19,5	0,6	14	7,8	0,335	7 000	0,16	► YAT 205
		52	34,1	15	33,7	19,8	0,6	11,9	7,8	0,335	4 300	0,19	► YAR 205-2RF/HV
52		34,1	15	33,7	19,8	0,6	11,9	7,8	0,335	4 300	0,19	► YAR 205-2RFGR/HV	
25	52	34,1	15	33,7	19,8	0,6	14	7,8	0,335	1 500	0,19	► YARAG 205	
	52	34,1	15	33,7	19,8	0,6	14	7,8	0,335	4 300	0,19	► YAR 205-2RF	
	52	34,1	15	33,7	19,8	0,6	14	7,8	0,335	4 300	0,19	► YAR 205-2RF/VE495	
	52	34,1	15	33,7	19,8	0,6	14	7,8	0,335	7 000	0,19	► YAR 205-2F	
	30	62	30,2	18	39,7	21	0,6	19,5	11,2	0,475	6 300	0,26	► YAT 206
62		38,1	18	39,7	22,2	0,6	16,3	11,2	0,475	3 800	0,3	► YAR 206-2RF/HV	
62		38,1	18	39,7	22,2	0,6	16,3	11,2	0,475	3 800	0,3	► YAR 206-2RFGR/HV	
62		38,1	18	39,7	22,2	0,6	19,5	11,2	0,475	1 200	0,3	YARAG 206	
62		38,1	18	39,7	22,2	0,6	19,5	11,2	0,475	3 800	0,31	► YAR 206-2RF	
62		38,1	18	39,7	22,2	0,6	19,5	11,2	0,475	3 800	0,31	► YAR 206-2RF/VE495	
30	62	38,1	18	39,7	22,2	0,6	19,5	11,2	0,475	6 300	0,31	► YAR 206-2F	
	35	72	33	19	46,1	23,3	1	25,5	15,3	0,655	5 300	0,38	► YAT 207
		72	42,9	19	46,1	25,4	1	21,6	15,3	0,655	3 200	0,45	► YAR 207-2RF/HV
72		42,9	19	46,1	25,4	1	21,6	15,3	0,655	3 200	0,45	► YAR 207-2RFGR/HV	
35	72	42,9	19	46,1	25,4	1	25,5	15,3	0,655	1 100	0,44	► YARAG 207	
	72	42,9	19	46,1	25,4	1	25,5	15,3	0,655	3 200	0,45	► YAR 207-2RF	
	72	42,9	19	46,1	25,4	1	25,5	15,3	0,655	3 200	0,45	► YAR 207-2RF/VE495	
	72	42,9	19	46,1	25,4	1	25,5	15,3	0,655	5 300	0,45	► YAR 207-2F	

► Popular item



Dimensions							Basic load ratings		Fatigue load limit	Limiting speed	Mass	Designation
d	D	B	C	d ₁ ≈	s ₁	r _{1,2} min.	C	C ₀	P _u	with shaft tolerance h6		
mm							kN		kN	r/min	kg	–
40	80	36	21	51,8	25,3	1	30,7	19	0,8	4 800	0,5	▶ YAT 208
	80	49,2	21	51,8	30,2	1	24,7	19	0,8	2 800	0,6	▶ YAR 208-2RF/HV
	80	49,2	21	51,8	30,2	1	24,7	19	0,8	2 800	0,6	▶ YAR 208-2RFGR/HV
	80	49,2	21	51,8	30,2	1	30,7	19	0,8	950	0,59	▶ YARAG 208
	80	49,2	21	51,8	30,2	1	30,7	19	0,8	2 800	0,6	▶ YAR 208-2RF
	80	49,2	21	51,8	30,2	1	30,7	19	0,8	2 800	0,61	▶ YAR 208-2RF/VE495
45	85	37	22	56,8	25,8	1	33,2	21,6	0,915	4 300	0,56	▶ YAT 209
	85	49,2	22	56,8	30,2	1	33,2	21,6	0,915	850	0,66	▶ YARAG 209
	85	49,2	22	56,8	30,2	1	33,2	21,6	0,915	2 400	0,67	▶ YAR 209-2RF
50	85	49,2	22	56,8	30,2	1	33,2	21,6	0,915	4 300	0,67	▶ YAR 209-2F
	90	38,8	22	62,5	27,6	1	35,1	23,2	0,98	4 000	0,63	▶ YAT 210
	90	51,6	22	62,5	32,6	1	29,6	23,2	0,98	2 200	0,76	▶ YAR 210-2RF/HV
	90	51,6	22	62,5	32,6	1	29,6	23,2	0,98	2 200	0,76	▶ YAR 210-2RFGR/HV
	90	51,6	22	62,5	32,6	1	35,1	23,2	0,98	800	0,75	▶ YARAG 210
	90	51,6	22	62,5	32,6	1	35,1	23,2	0,98	2 200	0,77	▶ YAR 210-2RF
55	90	51,6	22	62,5	32,6	1	35,1	23,2	0,98	2 200	0,77	▶ YAR 210-2RF/VE495
	90	51,6	22	62,5	32,6	1	35,1	23,2	0,98	4 000	0,76	▶ YAR 210-2F
60	100	55,6	25	69	33,4	1	43,6	29	1,25	1 900	1,05	▶ YAR 211-2RF
	100	55,6	25	69	33,4	1	43,6	29	1,25	3 600	1,05	▶ YAR 211-2F
65	110	65,1	26	75,6	39,7	1,5	52,7	36	1,53	1 800	1,4	▶ YAR 212-2RF
	110	65,1	26	75,6	39,7	1,5	52,7	36	1,53	3 400	1,4	▶ YAR 212-2F
70	120	68,3	27	82,5	42,9	1,5	57,2	40	1,7	1 600	1,8	▶ YAR 213-2RF
	120	68,3	27	82,5	42,9	1,5	57,2	40	1,7	3 000	1,8	▶ YAR 213-2F
75	125	69,9	28	87	39,7	1,5	62,4	45	1,86	2 800	1,95	▶ YAR 214-2F
80	130	73,3	29	92	46,3	1,5	66,3	49	2,04	2 600	2,15	▶ YAR 215-2F
85	140	77,8	30	97,4	47,6	2	72,8	53	2,16	2 400	2,5	▶ YAR 216-2F
90	160	89	36	112	54	2	95,6	72	2,7	2 000	4	▶ YAR 218-2F
100	180	98,4	40	124	63,4	1,9	124	93	3,35	1 900	5,6	▶ YAR 220-2F

2.2 Insert bearings with grub screws, inch shafts

d 1/2 – 1 3/4 in.

12,7 – 44,45 mm

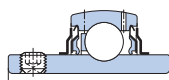
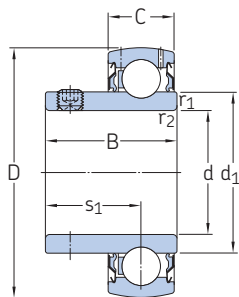

YAR ..-2F

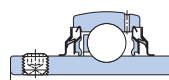

YAR ..-2RF/HV

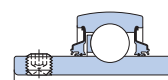

YARAG

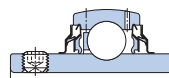

YAR ..-2RF

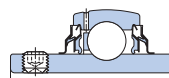

YAR ..-2RFGR/HV

YAT

Dimensions							Basic load ratings		Fatigue load limit	Limiting speed	Mass	Designation
d	D	B	C	d ₁	s ₁	r _{1,2} min.	C	C ₀	P _u	with shaft tolerance h6	kg	–
in./mm	mm						kN	kN	kN	r/min		
1/2 12,7	40	27,4	12	24,2	15,9	0,3	9,56	4,75	0,2	9 500	0,12	YAR 203-008-2F
5/8 15,875	40	22,1	12	24,2	15,9	0,3	9,56	4,75	0,2	9 500	0,09	YAT 203-010
	40	27,4	12	24,2	15,9	0,3	9,56	4,75	0,2	9 500	0,1	YAR 203-010-2F
3/4 19,05	47	25,5	14	28,2	18,3	0,6	12,7	6,55	0,28	8 500	0,14	YAT 204-012
	47	31	14	28,2	18,3	0,6	10,8	6,55	0,28	5 000	0,16	YAR 204-012-2RF/HV
	47	31	14	28,2	18,3	0,6	10,8	6,55	0,28	5 000	0,16	YAR 204-012-2RFGR/HV
	47	31	14	28,2	18,3	0,6	12,7	6,55	0,28	5 000	0,16	YAR 204-012-2RF
	47	31	14	28,2	18,3	0,6	12,7	6,55	0,28	5 000	0,16	YAR 204-012-2RF/VE495
	47	31	14	28,2	18,3	0,6	12,7	6,55	0,28	8 500	0,16	▶ YAR 204-012-2F
7/8 22,225	52	27,2	15	33,7	19,5	0,6	14	7,8	0,335	7 000	0,19	YAT 205-014
15/16 23,813	52	27,2	15	33,7	19,5	0,6	14	7,8	0,335	7 000	0,17	YAT 205-015
	52	34,1	15	33,7	19,8	0,6	14	7,8	0,335	4 300	0,21	YAR 205-015-2RF/VE495
	52	34,1	15	33,7	19,8	0,6	14	7,8	0,335	7 000	0,2	YAR 205-015-2F
1 25,4	52	27,2	15	33,7	19,5	0,6	14	7,8	0,335	7 000	0,16	YAT 205-100
	52	34,1	15	33,7	19,8	0,6	11,9	7,8	0,335	4 300	0,19	YAR 205-100-2RF/HV
	52	34,1	15	33,7	19,8	0,6	11,9	7,8	0,335	4 300	0,19	YAR 205-100-2RFGR/HV
	52	34,1	15	33,7	19,8	0,6	14	7,8	0,335	1 500	0,18	YARAG 205-100
	52	34,1	15	33,7	19,8	0,6	14	7,8	0,335	4 300	0,19	▶ YAR 205-100-2RF
	52	34,1	15	33,7	19,8	0,6	14	7,8	0,335	4 300	0,19	YAR 205-100-2RF/VE495
1 1/8 28,575	52	34,1	15	33,7	19,8	0,6	14	7,8	0,335	7 000	0,19	▶ YAR 205-100-2F
	62	38,1	18	39,7	22,2	0,6	19,5	11,2	0,475	6 300	0,35	YAR 206-101-2F
1 1/8 28,575	62	38,1	18	39,7	22,2	0,6	19,5	11,2	0,475	1 200	0,32	YARAG 206-102
	62	38,1	18	39,7	22,2	0,6	19,5	11,2	0,475	6 300	0,32	YAR 206-102-2F
1 3/16 30,163	62	30,2	18	39,7	21	0,6	19,5	11,2	0,475	6 300	0,26	YAT 206-103
	62	38,1	18	39,7	22,2	0,6	16,3	11,2	0,475	3 800	0,3	YAR 206-103-2RF/HV
	62	38,1	18	39,7	22,2	0,6	16,3	11,2	0,475	3 800	0,3	YAR 206-103-2RFGR/HV
1 3/16 30,163	62	38,1	18	39,7	22,2	0,6	19,5	11,2	0,475	1 200	0,3	YARAG 206-103
	62	38,1	18	39,7	22,2	0,6	19,5	11,2	0,475	3 800	0,3	YAR 206-103-2RF/VE495
	62	38,1	18	39,7	22,2	0,6	19,5	11,2	0,475	6 300	0,3	YAR 206-103-2F

▶ Popular item



Dimensions							Basic load ratings		Fatigue load limit	Limiting speed	Mass	Designation
d	D	B	C	d ₁	s ₁	r _{1,2}	C	C ₀	P _u	with shaft tolerance h6		
in./mm	mm			≈		min.	kN		kN	r/min	kg	–
1 1/4 31,75	62	30,2	18	39,7	21	0,6	19,5	11,2	0,475	6 300	0,24	YAT 206-104
	62	38,1	18	39,7	22,2	0,6	16,3	11,2	0,475	3 800	0,28	YAR 206-104-2RF/HV
	62	38,1	18	39,7	22,2	0,6	16,3	11,2	0,475	3 800	0,28	YAR 206-104-2RFGR/HV
	62	38,1	18	39,7	22,2	0,6	19,5	11,2	0,475	1 200	0,27	YARAG 206-104
	62	38,1	18	39,7	22,2	0,6	19,5	11,2	0,475	3 800	0,28	YAR 206-104-2RF/VE495
	62	38,1	18	39,7	22,2	0,6	19,5	11,2	0,475	6 300	0,28	YAR 206-104-2F
	72	42,9	19	46,1	25,4	1	21,6	15,3	0,655	3 200	0,5	▶ YAR 207-104-2RF/HV
	72	42,9	19	46,1	25,4	1	21,6	15,3	0,655	3 200	0,5	YAR 207-104-2RFGR/HV
	72	42,9	19	46,1	25,4	1	25,5	15,3	0,655	1 100	0,49	YARAG 207-104
	72	42,9	19	46,1	25,4	1	25,5	15,3	0,655	3 200	0,51	YAR 207-104-2RF
	72	42,9	19	46,1	25,4	1	25,5	15,3	0,655	3 200	0,51	YAR 207-104-2RF/VE495
	72	42,9	19	46,1	25,4	1	25,5	15,3	0,655	5 300	0,5	▶ YAR 207-104-2F
1 5/16 33,338	72	42,9	19	46,1	25,4	1	25,5	15,3	0,655	5 300	0,48	YAR 207-105-2F
1 3/8 34,925	72	42,9	19	46,1	25,4	1	21,6	15,3	0,655	3 200	0,45	YAR 207-106-2RF/HV
	72	42,9	19	46,1	25,4	1	21,6	15,3	0,655	3 200	0,45	YAR 207-106-2RFGR/HV
	72	42,9	19	46,1	25,4	1	25,5	15,3	0,655	1 100	0,44	YARAG 207-106
	72	42,9	19	46,1	25,4	1	25,5	15,3	0,655	3 200	0,45	YAR 207-106-2RF/VE495
	72	42,9	19	46,1	25,4	1	25,5	15,3	0,655	5 300	0,45	YAR 207-106-2F
1 7/16 36,513	72	33	19	46,1	23,3	1	25,5	15,3	0,655	5 300	0,36	YAT 207-107
	72	42,9	19	46,1	25,4	1	21,6	15,3	0,655	3 200	0,42	▶ YAR 207-107-2RF/HV
	72	42,9	19	46,1	25,4	1	21,6	15,3	0,655	3 200	0,42	YAR 207-107-2RFGR/HV
	72	42,9	19	46,1	25,4	1	25,5	15,3	0,655	1 100	0,41	YARAG 207-107
	72	42,9	19	46,1	25,4	1	25,5	15,3	0,655	3 200	0,42	YAR 207-107-2RF/VE495
	72	42,9	19	46,1	25,4	1	25,5	15,3	0,655	5 300	0,42	YAR 207-107-2F
	80	49,2	21	51,8	30,2	1	30,7	19	0,8	4 800	0,68	YAR 208-107-2F
1 1/2 38,1	80	36	21	51,8	25,3	1	30,7	19	0,8	4 800	0,53	YAT 208-108
	80	49,2	21	51,8	30,2	1	24,7	19	0,8	2 800	0,65	▶ YAR 208-108-2RF/HV
	80	49,2	21	51,8	30,2	1	24,7	19	0,8	2 800	0,65	YAR 208-108-2RFGR/HV
	80	49,2	21	51,8	30,2	1	30,7	19	0,8	950	0,63	YARAG 208-108
	80	49,2	21	51,8	30,2	1	30,7	19	0,8	2 800	0,65	▶ YAR 208-108-2RF
	80	49,2	21	51,8	30,2	1	30,7	19	0,8	2 800	0,65	YAR 208-108-2RF/VE495
	80	49,2	21	51,8	30,2	1	30,7	19	0,8	4 800	0,65	▶ YAR 208-108-2F
	85	49,2	22	56,8	30,2	1	33,2	21,6	0,915	4 300	0,84	YAR 209-108-2F
1 9/16 39,688	80	49,2	21	51,8	30,2	1	30,7	19	0,8	4 800	0,61	YAR 208-109-2F
1 5/8 41,275	85	49,2	22	56,8	30,2	1	33,2	21,6	0,915	850	0,75	YARAG 209-110
	85	49,2	22	56,8	30,2	1	33,2	21,6	0,915	4 300	0,77	YAR 209-110-2F
1 11/16 42,863	85	37	22	56,8	25,8	1	33,2	21,6	0,915	4 300	0,61	YAT 209-111
	85	49,2	22	56,8	30,2	1	33,2	21,6	0,915	850	0,71	YARAG 209-111
	85	49,2	22	56,8	30,2	1	33,2	21,6	0,915	4 300	0,73	YAR 209-111-2F
1 3/4 44,45	85	37	22	56,8	25,8	1	33,2	21,6	0,915	4 300	0,58	YAT 209-112
	85	49,2	22	56,8	30,2	1	33,2	21,6	0,915	2 400	0,69	YAR 209-112-2RF
	85	49,2	22	56,8	30,2	1	33,2	21,6	0,915	4 300	0,69	▶ YAR 209-112-2F

▶ Popular item

2.2 Insert bearings with grub screws, inch shafts

d 1 15/16 – 3 in.

49,213 – 76,2 mm

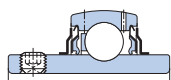
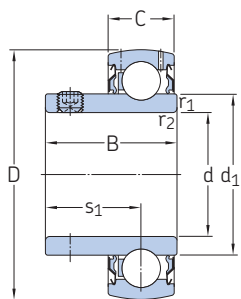

YAR ..-2F

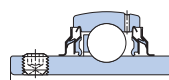

YAR ..-2RF/HV

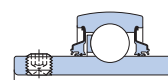

YARAG

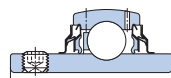

YAR ..-2RF

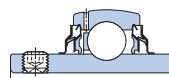

YAR ..-2RFGR/HV

YAT

Dimensions							Basic load ratings		Fatigue load limit	Limiting speed	Mass	Designation
d	D	B	C	d ₁	s ₁	r _{1,2} min.	C	C ₀	P _u	with shaft tolerance h6	kg	–
in./mm	mm			≈			kN	kN	kN	r/min		
1 15/16 49,213	90	38,8	22	62,5	27,6	1	35,1	23,2	0,98	4 000	0,65	YAT 210-115
	90	51,6	22	62,5	32,6	1	29,6	23,2	0,98	2 200	0,79	YAR 210-115-2RF/HV
	90	51,6	22	62,5	32,6	1	29,6	23,2	0,98	2 200	0,79	YAR 210-115-2RFGR/HV
	90	51,6	22	62,5	32,6	1	35,1	23,2	0,98	800	0,77	YARAG 210-115
	90	51,6	22	62,5	32,6	1	35,1	23,2	0,98	2 200	0,79	YAR 210-115-2RF
	90	51,6	22	62,5	32,6	1	35,1	23,2	0,98	2 200	0,79	YAR 210-115-2RF/VE495
2 50,8	90	51,6	22	62,5	32,6	1	35,1	23,2	0,98	4 000	0,79	YAR 210-115-2F
	100	45	25	69	32,5	1	43,6	29	1,25	3 600	1	YAT 211-200
	100	55,6	25	69	33,4	1	43,6	29	1,25	1 900	1,2	YAR 211-200-2RF
2 3/16 55,563	100	55,6	25	69	33,4	1	43,6	29	1,25	3 600	1	YAR 211-200-2F
	110	65,1	26	75,6	39,7	1,5	52,7	36	1,53	3 400	1,6	YAR 212-203-2F
2 1/4 57,15	110	48,5	26	75,6	35	1,5	52,7	36	1,53	3 400	1,25	YAT 212-204
	110	65,1	26	75,6	39,7	1,5	52,7	36	1,53	3 400	1,55	YAR 212-204-2F
2 7/16 61,913	110	48,5	26	75,6	35	1,5	52,7	36	1,53	3 400	1,1	YAT 212-207
	110	65,1	26	75,6	39,7	1,5	52,7	36	1,53	3 400	1,3	YAR 212-207-2F
	125	69,9	28	87	39,7	1,5	62,4	45	1,86	2 800	2,4	YAR 214-207-2F
2 1/2 63,5	120	68,3	27	82,5	42,9	1,5	57,2	40	1,7	1 600	1,9	YAR 213-208-2RF
	120	68,3	27	82,5	42,9	1,5	57,2	40	1,7	3 000	1,85	YAR 213-208-2F
	125	69,9	28	87	39,7	1,5	62,4	45	1,86	2 800	2,3	YAR 214-208-2F
2 11/16 68,263	120	68,3	27	82,5	42,9	1,5	57,2	40	1,7	3 000	1,6	YAR 213-211-2F
2 15/16 74,613	130	53,5	29	92	39	1,5	66,3	49	2,04	2 600	1,75	YAT 215-215
	130	73,3	29	92	46,3	1,5	66,3	49	2,04	2 600	2,15	YAR 215-215-2F
3 76,2	140	55,5	30	97,4	39	2	72,8	53	2,16	2 400	2,2	YAT 216-300
	140	77,8	30	97,4	47,6	2	72,8	53	2,16	2 400	2,8	YAR 216-300-2F

► Popular item



2.3 Insert bearings with an eccentric locking collar, metric shafts

d 15 – 60 mm

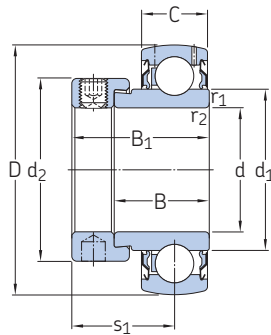

YET

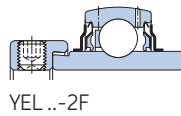

YEL...-2F

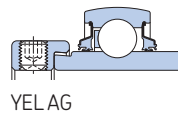

YELAG

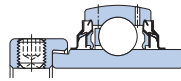

YEL...-2RF

Dimensions									Basic load ratings		Fatigue load limit	Limiting speed with shaft tolerance h6	Mass	Designation
d	D	B	B ₁	C	d ₁ ≈	d ₂	s ₁	r _{1,2} min.	dynamic	static				
mm									kN	kN	r/min	kg	–	
15	40	19,1	28,6	12	24,2	27,2	22,1	0,3	9,56	4,75	0,2	9 500	0,12	► YET 203/15
17	40	19,1	28,6	12	24,2	27,2	22,1	0,3	9,56	4,75	0,2	9 500	0,11	► YET 203
20	47	21	30,5	14	28,2	32,4	23,5	0,6	12,7	6,55	0,28	8 500	0,16	► YET 204
	47	21	30,5	14	28,2	32,4	23,5	0,6	12,7	6,55	0,28	8 500	0,16	► YET 204/VL065
	47	34,2	43,7	14	28,2	32,4	26,6	0,6	12,7	6,55	0,28	1 800	0,2	► YELAG 204
25	47	34,2	43,7	14	28,2	32,4	26,6	0,6	12,7	6,55	0,28	5 000	0,2	► YEL 204-2RF/VL065
	47	34,2	43,7	14	28,2	32,4	26,6	0,6	12,7	6,55	0,28	8 500	0,2	► YEL 204-2F
25	52	21,5	31	15	33,7	37,4	23,5	0,6	14	7,8	0,335	7 000	0,2	► YET 205
	52	21,5	31	15	33,7	37,4	23,5	0,6	14	7,8	0,335	7 000	0,2	► YET 205/VL065
	52	34,9	44,4	15	33,7	37,4	26,9	0,6	14	7,8	0,335	1 500	0,24	► YELAG 205
30	52	34,9	44,4	15	33,7	37,4	26,9	0,6	14	7,8	0,335	4 300	0,25	► YEL 205-2RF/VL065
	52	34,9	44,4	15	33,7	37,4	26,9	0,6	14	7,8	0,335	7 000	0,24	► YEL 205-2F
30	62	23,8	35,7	18	39,7	44,1	26,7	0,6	19,5	11,2	0,475	6 300	0,32	► YET 206
	62	23,8	35,7	18	39,7	44,1	26,7	0,6	19,5	11,2	0,475	6 300	0,32	► YET 206/VL065
	62	36,5	48,4	18	39,7	44,1	30,1	0,6	19,5	11,2	0,475	1 200	0,38	► YELAG 206
35	62	36,5	48,4	18	39,7	44,1	30,1	0,6	19,5	11,2	0,475	3 800	0,38	► YEL 206-2RF/VL065
	62	36,5	48,4	18	39,7	44,1	30,1	0,6	19,5	11,2	0,475	6 300	0,38	► YEL 206-2F
35	72	25,4	38,9	19	46,1	51,1	29,4	1	25,5	15,3	0,655	5 300	0,46	► YET 207
	72	25,4	38,9	19	46,1	51,1	29,4	1	25,5	15,3	0,655	5 300	0,46	► YET 207/VL065
	72	37,6	51,1	19	46,1	51,1	32,3	1	25,5	15,3	0,655	1 100	0,53	► YELAG 207
40	72	37,6	51,1	19	46,1	51,1	32,3	1	25,5	15,3	0,655	3 200	0,54	► YEL 207-2RF/VL065
	72	37,6	51,1	19	46,1	51,1	32,3	1	25,5	15,3	0,655	5 300	0,54	► YEL 207-2F
40	80	29,7	43,2	21	51,8	56,5	32,7	1	30,7	19	0,8	4 800	0,6	► YET 208
	80	29,7	43,2	21	51,8	56,5	32,7	1	30,7	19	0,8	4 800	0,6	► YET 208/VL065
	80	42,8	56,3	21	51,8	56,5	34,9	1	30,7	19	0,8	950	0,69	► YELAG 208
40	80	42,8	56,3	21	51,8	56,5	34,9	1	30,7	19	0,8	2 800	0,71	► YEL 208-2RF/VL065
	80	42,8	56,3	21	51,8	56,5	34,9	1	30,7	19	0,8	4 800	0,7	► YEL 208-2F

► Popular item

Dimensions									Basic load ratings		Fatigue load limit	Limiting speed with shaft tolerance h6	Mass	Designation
d	D	B	B ₁	C	d ₁ ≈	d ₂	s ₁	r _{1,2} min.	C	C ₀				
mm									kN	kN	r/min	kg	–	
45	85	30,2	43,7	22	56,8	62	32,7	1	33,2	21,6	0,915	4 300	0,68	▶ YET 209
	85	42,8	56,3	22	56,8	62	34,9	1	33,2	21,6	0,915	850	0,78	▶ YELAG 209
	85	42,8	56,3	22	56,8	62	34,9	1	33,2	21,6	0,915	4 300	0,79	▶ YEL 209-2F
50	90	30,2	43,7	22	62,5	67,2	32,7	1	35,1	23,2	0,98	4 000	0,74	▶ YET 210
	90	49,2	62,7	22	62,5	67,2	38,1	1	35,1	23,2	0,98	800	0,9	▶ YELAG 210
	90	49,2	62,7	22	62,5	67,2	38,1	1	35,1	23,2	0,98	4 000	0,92	▶ YEL 210-2F
55	100	32,6	48,4	25	69	74,5	35,9	1	43,6	29	1,25	3 600	1,05	▶ YET 211
	100	55,6	71,4	25	69	74,5	43,6	1	43,6	29	1,25	3 600	1,3	▶ YEL 211-2F
60	110	36,7	52,6	26	75,6	82	39,6	1,5	52,7	36	1,53	3 400	1,35	▶ YET 212
	110	61,9	77,8	26	75,6	82	46,8	1,5	52,7	36	1,53	3 400	1,7	▶ YEL 212-2F



2.4 Insert bearings with an eccentric locking collar, inch shafts

d 1/2 – 2 7/16 in.
12,7 – 61,913 mm

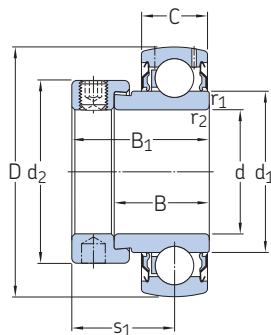

YET

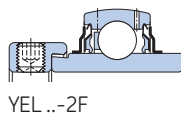

YEL ..-2F

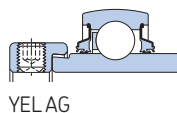

YELAG

Dimensions									Basic load ratings		Fatigue load limit	Limiting speed	Mass	Designation
d	D	B	B ₁	C	d ₁	d ₂	s ₁	r _{1,2} min.	C	C ₀	P _u	with shaft tolerance h6	kg	–
in./mm mm									kN		kN	r/min	kg	–
1/2 12,7	40	19,1	28,6	12	24,2	27,2	22,1	0,3	9,56	4,75	0,2	9 500	0,13	YET 203-008
3/4 19,05	47 47	21 34,2	30,5 43,7	14 14	28,2 28,2	32,4 32,4	23,5 26,6	0,6 0,6	12,7 12,7	6,55 6,55	0,28 0,28	8 500 8 500	0,17 0,21	► YET 204-012 YEL 204-012-2F
1 25,4	52 52 52	21,5 34,9 34,9	31 44,4 44,4	15 15 15	33,7 33,7 33,7	37,4 37,4 37,4	23,5 26,9 26,9	0,6 0,6 0,6	14 14 14	7,8 7,8 7,8	0,335 0,335 0,335	7 000 1 500 7 000	0,19 0,23 0,24	► YET 205-100 YELAG 205-100 YEL 205-100-2F
1 1/8 28,575	62 62 62	23,8 36,5 36,5	35,7 48,4 48,4	18 18 18	39,7 39,7 39,7	44,1 44,1 44,1	26,7 30,1 30,1	0,6 0,6 0,6	19,5 19,5 19,5	11,2 11,2 11,2	0,475 0,475 0,475	6 300 1 200 6 300	0,34 0,4 0,41	YET 206-102 YELAG 206-102 YEL 206-102-2F
1 3/16 30,163	62 62 62	23,8 36,5 36,5	35,7 48,4 48,4	18 18 18	39,7 39,7 39,7	44,1 44,1 44,1	26,7 30,1 30,1	0,6 0,6 0,6	19,5 19,5 19,5	11,2 11,2 11,2	0,475 0,475 0,475	6 300 1 200 6 300	0,32 0,37 0,38	YET 206-103 YELAG 206-103 YEL 206-103-2F
1 1/4 31,75	62 72 72	23,8 25,4 37,6	35,7 38,9 51,1	18 19 19	39,7 46,1 46,1	44,1 51,1 51,1	26,7 29,4 32,3	0,6 1 1	19,5 25,5 25,5	11,2 15,3 15,3	0,475 0,655 0,655	6 300 5 300 1 100	0,3 0,51 0,6	YET 206-104 YET 207-104 YELAG 207-104
	72	37,6	51,1	19	46,1	51,1	32,3	1	25,5	15,3	0,655	5 300	0,61	YEL 207-104-2F
1 5/16 33,338	72	25,4	38,9	19	46,1	51,1	29,4	1	25,5	15,3	0,655	5 300	0,49	YET 207-105
1 3/8 34,925	72 72 72	25,4 37,6 37,6	38,9 51,1 51,1	19 19 19	46,1 46,1 46,1	51,1 51,1 51,1	29,4 32,3 32,3	1 1 1	25,5 25,5 25,5	15,3 15,3 15,3	0,655 0,655 0,655	5 300 1 100 5 300	0,46 0,54 0,55	YET 207-106 YELAG 207-106 YEL 207-106-2F
1 7/16 36,513	72 72 72	25,4 37,6 37,6	38,9 51,1 51,1	19 19 19	46,1 46,1 46,1	51,1 51,1 51,1	29,4 32,3 32,3	1 1 1	25,5 25,5 25,5	15,3 15,3 15,3	0,655 0,655 0,655	5 300 1 100 5 300	0,44 0,5 0,51	YET 207-107 YELAG 207-107 YEL 207-107-2F
1 1/2 38,1	80 80 80	29,7 42,8 42,8	43,2 56,3 56,3	21 21 21	51,8 51,8 51,8	56,5 56,5 56,5	32,7 34,9 34,9	1 1 1	30,7 30,7 30,7	19 19 19	0,8 0,8 0,8	4 800 950 4 800	0,64 0,74 0,76	► YET 208-108 YELAG 208-108 YEL 208-108-2F
1 11/16 42,863	85 85 85	30,2 42,8 42,8	43,7 56,3 56,3	22 22 22	56,8 56,8 56,8	62 62 62	32,7 34,9 34,9	1 1 1	33,2 33,2 33,2	21,6 21,6 21,6	0,915 0,915 0,915	4 300 850 4 300	0,73 0,84 0,86	YET 209-111 YELAG 209-111 YEL 209-111-2F

► Popular item

Dimensions									Basic load ratings		Fatigue load limit	Limiting speed with shaft tolerance h6	Mass	Designation
d	D	B	B ₁	C	d ₁ ≈	d ₂	s ₁	r _{1,2} min.	C	C ₀				
in./mm	mm								kN		kN	r/min	kg	–
1 3/4	85	30,2	43,7	22	56,8	62	32,7	1	33,2	21,6	0,915	4 300	0,69	YET 209-112
44,45	85	42,8	56,3	22	56,8	62	34,9	1	33,2	21,6	0,915	850	0,8	YELAG 209-112
	85	42,8	56,3	22	56,8	62	34,9	1	33,2	21,6	0,915	4 300	0,81	YEL 209-112-2F
1 15/16	90	49,2	62,7	22	62,5	67,2	38,1	1	35,1	23,2	0,98	800	0,94	YELAG 210-115
49,213	90	49,2	62,7	22	62,5	67,2	38,1	1	35,1	23,2	0,98	4 000	0,95	YEL 210-115-2F
2	100	55,6	71,4	25	69	74,5	43,6	1	43,6	29	1,25	3 600	1,5	YEL 211-200-2F
50,8														
2 3/16	100	55,6	71,4	25	69	74,5	43,6	1	43,6	29	1,25	3 600	1,25	YEL 211-203-2F
55,563														
2 7/16	110	36,7	52,6	26	75,6	82	39,6	1,5	52,7	36	1,53	3 400	1,25	YET 212-207
61,913	110	61,9	77,8	26	75,6	82	46,8	1,5	52,7	36	1,53	3 400	1,6	YEL 212-207-2F



2.5 SKF ConCentra insert bearings, metric shafts

d 25 – 60 mm

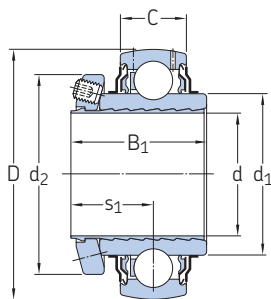

YSP .. SB-2F

Dimensions							Basic load ratings		Fatigue load limit	Limiting speed	Mass	Designation
d	D	B ₁ ¹⁾	C	d ₁	d ₂	s ₁ ¹⁾	C	C ₀	P _u			
mm							kN			r/min	kg	–
25	52	33,2	15	33,7	41,7	21,2	14	7,8	0,335	1 500	0,18	YSPAG 205
	52	33,2	15	33,7	41,7	21,2	14	7,8	0,335	7 000	0,19	YSP 205 SB-2F
30	62	37,2	18	39,7	48	23,2	19,5	11,2	0,475	1 200	0,3	YSPAG 206
	62	37,2	18	39,7	48	23,2	19,5	11,2	0,475	6 300	0,31	YSP 206 SB-2F
35	72	39,7	19	46,1	57	24,5	25,5	15,3	0,655	1 100	0,44	YSPAG 207
	72	39,7	19	46,1	57	24,5	25,5	15,3	0,655	5 300	0,45	▶ YSP 207 SB-2F
40	80	43,1	21	51,8	62	26,2	30,7	19	0,8	950	0,58	YSPAG 208
	80	43,1	21	51,8	62	26,2	30,7	19	0,8	4 800	0,59	▶ YSP 208 SB-2F
45	85	44,2	22	56,8	67	26,7	33,2	21,6	0,915	850	0,64	YSPAG 209
	85	44,2	22	56,8	67	26,7	33,2	21,6	0,915	4 300	0,66	YSP 209 SB-2F
50	90	46,2	22	62,5	72	27,7	35,1	23,2	0,98	800	0,72	YSPAG 210
	90	46,2	22	62,5	72	27,7	35,1	23,2	0,98	4 000	0,74	▶ YSP 210 SB-2F
55	100	49,2	25	69	77,6	29,2	43,6	29	1,25	3 600	0,98	YSP 211 SB-2F
60	110	51,7	26	75,6	83	30,5	52,7	36	1,53	3 400	1,25	YSP 212 SB-2F

▶ Popular item

¹⁾ Width/distance before the grub screw is tightened (sleeve and inner ring bore at starting position).

2.6 SKF ConCentra insert bearings, inch shafts

d 1 – 2 11/16 in.

25,4 – 68,263 mm

Dimensions							Basic load ratings		Fatigue load limit	Limiting speed	Mass	Designation
d	D	B ₁ ¹⁾	C	d ₁	d ₂	s ₁ ¹⁾	dynamic	static				
in./mm	mm	≈		≈		≈	kN		kN	r/min	kg	–
1	52	33,2	15	33,74	41,7	21,2	14	7,8	0,335	1 500	0,18	YSPAG 205-100
25,4	52	33,2	15	33,74	41,7	21,2	14	7,8	0,335	7 000	0,18	YSP 205-100 SB-2F
1 3/16	62	37,2	18	39,7	48	23,2	19,5	11,2	0,475	1 200	0,3	YSPAG 206-103
30,163	62	37,2	18	39,7	48	23,2	19,5	11,2	0,475	6 300	0,3	YSP 206-103 SB-2F
1 1/4	72	39,7	19	46,1	57	24,5	25,5	15,3	0,655	1 100	0,49	YSPAG 207-104
31,75	72	39,7	19	46,1	57	24,5	25,5	15,3	0,655	5 300	0,5	YSP 207-104 SB-2F
1 3/8	72	39,7	19	46,1	57	24,5	25,5	15,3	0,655	1 100	0,44	YSPAG 207-106
34,925	72	39,7	19	46,1	57	24,5	25,5	15,3	0,655	5 300	0,45	YSP 207-106 SB-2F
1 7/16	72	39,7	19	46,1	57	24,5	25,5	15,3	0,655	1 100	0,42	YSPAG 207-107
36,513	72	39,7	19	46,1	57	24,5	25,5	15,3	0,655	5 300	0,42	YSP 207-107 SB-2F
1 1/2	80	43,1	21	51,8	62	26,2	30,7	19	0,8	950	0,61	YSPAG 208-108
38,1	80	43,1	21	51,8	62	26,2	30,7	19	0,8	4 800	0,62	YSP 208-108 SB-2F
1 11/16	85	44,2	22	56,8	67	26,7	33,2	21,6	0,915	850	0,69	YSPAG 209-111
42,863	85	44,2	22	56,8	67	26,7	33,2	21,6	0,915	4 300	0,7	YSP 209-111 SB-2F
1 15/16	90	46,2	22	62,51	72	27,7	35,1	23,2	0,98	800	0,74	YSPAG 210-115
49,213	90	46,2	22	62,51	72	27,7	35,1	23,2	0,98	4 000	0,76	YSP 210-115 SB-2F
2	100	49,2	25	69,06	77,6	29,2	43,6	29	1,25	3 600	1,1	YSP 211-200 SB-2F
50,8												
2 3/16	100	49,2	25	69,06	77,6	29,2	43,6	29	1,25	3 600	0,97	YSP 211-203 SB-2F
55,563												
2 1/4	110	51,7	26	75,64	83	30,5	52,7	36	1,53	3 400	1,35	YSP 212-204 SB-2F
57,15												
2 7/16	110	51,7	26	75,64	87,6	30,5	52,7	36	1,53	3 400	1,2	YSP 212-207 SB-2F
61,913												
2 11/16	120	52,7	27	82,5	89,4	31	57,2	40	1,7	3 000	1,4	YSP 213-211 SB-2F
68,263												

► Popular item

¹⁾ Width/distance before the grub screw is tightened (sleeve and inner ring bore at starting position).



2.7 Insert bearings with a tapered bore on an adapter sleeve, metric shafts

d 20 – 60 mm

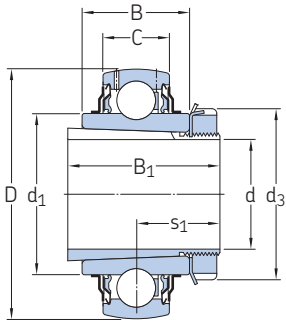

2.7



Dimensions								Basic load ratings		Fatigue load limit	Limiting speed	Mass Bearing + sleeve	Designations Bearing	Adapter sleeve
d	D	B	B ₁	C	d ₁	d ₃	s ₁ ¹⁾	C	C ₀	P _u				
mm								kN		kN	r/min	kg	–	
20	52	24	35	15	33,7	38	20,5	14	7,8	0,335	7 000	0,25	YSA 205-2FK	H 2305
25	62	28	38	18	39,7	45	22,5	19,5	11,2	0,475	6 300	0,38	YSA 206-2FK	H 2306
30	72	30,5	43	19	46,1	52	24,8	25,5	15,3	0,655	5 300	0,54	YSA 207-2FK	H 2307
35	80	33,9	46	21	51,8	58	27,5	30,7	19	0,8	4 800	0,71	YSA 208-2FK	H 2308
40	85	35	50	22	56,8	65	29	33,2	21,6	0,915	4 300	0,84	YSA 209-2FK	H 2309
45	90	37	55	22	62,5	70	31,1	35,1	23,2	0,98	4 000	0,97	YSA 210-2FK	H 2310
50	100	40	59	25	69	75	32,5	43,6	29	1,25	3 600	1,25	YSA 211-2FK	H 2311
55	110	42,5	62	26	75,6	80	33,8	52,7	36	1,53	3 400	1,55	YSA 212-2FK	H 2312
60	120	43,5	65	27	82,5	85	35,3	57,2	40	1,7	3 000	1,9	YSA 213-2FK	H 2313

¹⁾ Distance before the sleeve is driven into the bearing bore (sleeve and inner ring bore at starting position).

2.8 Insert bearings with a tapered bore on an adapter sleeve, inch shafts

d $\frac{3}{4}$ – $2\frac{1}{4}$ in.

19,05 – 57,15 mm

Dimensions								Basic load ratings		Fatigue load limit	Limiting speed	Mass Bearing + sleeve	Designations Bearing	Adapter sleeve
d	D	B	B ₁	C	d ₁ ≈	d ₃	s ₁ ¹⁾ ≈	C	C ₀	P _u				
in./mm	mm							kN			r/min	kg		
$\frac{3}{4}$ 19,05	52	24	35	15	33,74	38	20,5	14	7,8	0,335	7 000	0,25	YSA 205-2FK	HE 2305
$\frac{15}{16}$ 23,813	62	28	38	18	39,7	45	22,5	19,5	11,2	0,475	6 300	0,39	YSA 206-2FK	HA 2306
1 25,4	62	28	38	18	39,7	45	22,5	19,5	11,2	0,475	6 300	0,37	YSA 206-2FK	HE 2306
1.187 30,136	72	30,5	43	19	46,1	52	24,8	25,5	15,3	0,655	5 300	0,54	YSA 207-2FK	HA 2307
1 $\frac{1}{4}$ 31,75	80	33,9	46	21	51,8	58	27,5	30,7	19	0,8	4 800	0,77	YSA 208-2FK	HE 2308
1 $\frac{7}{16}$ 36,513	85	35	50	22	56,8	65	29	33,2	21,6	0,915	4 300	0,92	YSA 209-2FK	HA 2309
1 $\frac{1}{2}$ 38,1	85	35	50	22	56,8	65	29	33,2	21,6	0,915	4 300	0,88	YSA 209-2FK	HE 2309
1 $\frac{11}{16}$ 42,863	90	37	55	22	62,51	70	31,1	35,1	23,2	0,98	4 000	1,05	YSA 210-2FK	HA 2310
1 $\frac{3}{4}$ 44,45	90	37	55	22	62,51	70	31,1	35,1	23,2	0,98	4 000	0,98	YSA 210-2FK	HE 2310
1 $\frac{15}{16}$ 49,213	100	40	59	25	69,06	75	32,5	43,6	29	1,25	3 600	1,3	YSA 211-2FK	HA 2311
2 50,8	100	40	59	25	69,06	75	32,5	43,6	29	1,25	3 600	1,2	YSA 211-2FK	HE 2311 B
2 $\frac{3}{16}$ 55,563	120	43,5	65	27	82,5	85	35,3	57,2	40	1,7	3 000	2,1	YSA 213-2FK	HA 2313
2 $\frac{1}{4}$ 57,15	120	43,5	65	27	82,5	85	35,3	57,2	40	1,7	3 000	2,05	YSA 213-2FK	HE 2313

¹⁾ Distance before the sleeve is driven into the bearing bore (sleeve and inner ring bore at starting position).



2.9 Insert bearings with a standard inner ring, metric shafts

d 17 – 60 mm

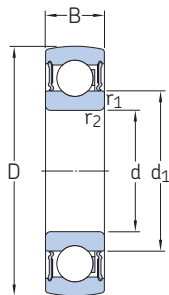

B-2RS1/VP274

-2RS1

Dimensions					Basic load ratings		Fatigue load limit	Limiting speed	Mass	Designation
d	D	B	d ₁ ≈	r _{1,2} min.	C	C ₀	P _u			
mm					kN		kN	r/min	kg	–
17	40	12	24,5	0,6	9,56	4,75	0,2	12 000	0,06	▶ 1726203-2RS1
20	47	14	28,8	1	12,7	6,55	0,28	10 000	0,1	▶ 1726204-2RS1
25	52	15	34,3	1	14	7,8	0,335	8 500	0,12	▶ 1726205-2RS1
	62	17	36,6	1,1	22,5	11,6	0,49	7 500	0,22	1726305-2RS1
30	62	16	40,3	1	19,5	11,2	0,475	7 500	0,19	▶ 1726206-2RS1
	72	19	44,6	1,1	28,1	16	0,67	6 300	0,34	1726306-2RS1
35	72	17	46,9	1,1	25,5	15,3	0,655	6 300	0,28	▶ 1726207-2RS1
	80	21	49,5	1,5	33,2	19	0,815	6 000	0,44	▶ 1726307-2RS1
40	80	18	52,6	1,1	30,7	19	0,8	5 600	0,35	▶ 1726208-2RS1
	90	23	56,1	1,5	41	24	1	5 000	0,61	▶ 1726308-2RS1
45	85	19	56,6	1	33,2	21,6	0,915	4 300	0,39	1726209 B-2RS1/VP274
	85	19	56,6	1	33,2	21,6	0,915	5 000	0,4	▶ 1726209-2RS1
	100	25	62,1	1,5	52,7	31,5	1,34	4 500	0,8	1726309-2RS1
	100	25	62,1	1,5	52,7	31,5	1,34	4 500	0,81	1726309 B-2RS1/VP274
50	90	20	62,5	1,1	35,1	23,2	0,98	4 800	0,44	▶ 1726210-2RS1
	110	27	68,7	2	61,8	38	1,6	4 300	1	1726310 B-2RS1/VP274
	110	27	68,7	2	61,8	38	1,6	4 300	1,05	1726310-2RS1
55	100	21	69	1,5	43,6	29	1,25	4 300	0,6	▶ 1726211-2RS1
60	110	22	75,5	1,5	52,7	36	1,53	4 000	0,77	▶ 1726212-2RS1

▶ Popular items

