

DIAPHRAGM PUMPS

MICROBOXER



MADE IN ITALY 

- **Product of Italian origin**
- **Patented** stall protection pneumatic circuit
- Works with **non**-lubricated air
- **Self priming**
- Idles without damage
- Possibility of adjusting the pumping speed
- Versatility of use
- Broad choice of materials that are compatible with the fluid to be pumped
- Particularly suitable for heavy duty applications
- Atex zone 1 (*on request*) - Atex zone 2 standard
- Customisable suction/delivery fitting position (*on request*)
- Available with reinforcement rings (*on request*)
- Available with NPT fittings (*on request, only for pumps and AISI 316 and Alu*)
- Available with clamp / din connections (*on request, only for stainless steel pumps*)
- Diaphragms with "long life" profile
- Diaphragms in various materials
- Suitable for pumping high viscosity fluids
- High performance
- High power and sturdiness
- Continuous operation: YES
- Warranty: 1 year - according to our general conditions of sale
- Spare parts: to identify the spare parts check the exploded views provided at the end of the operation and maintenance manual

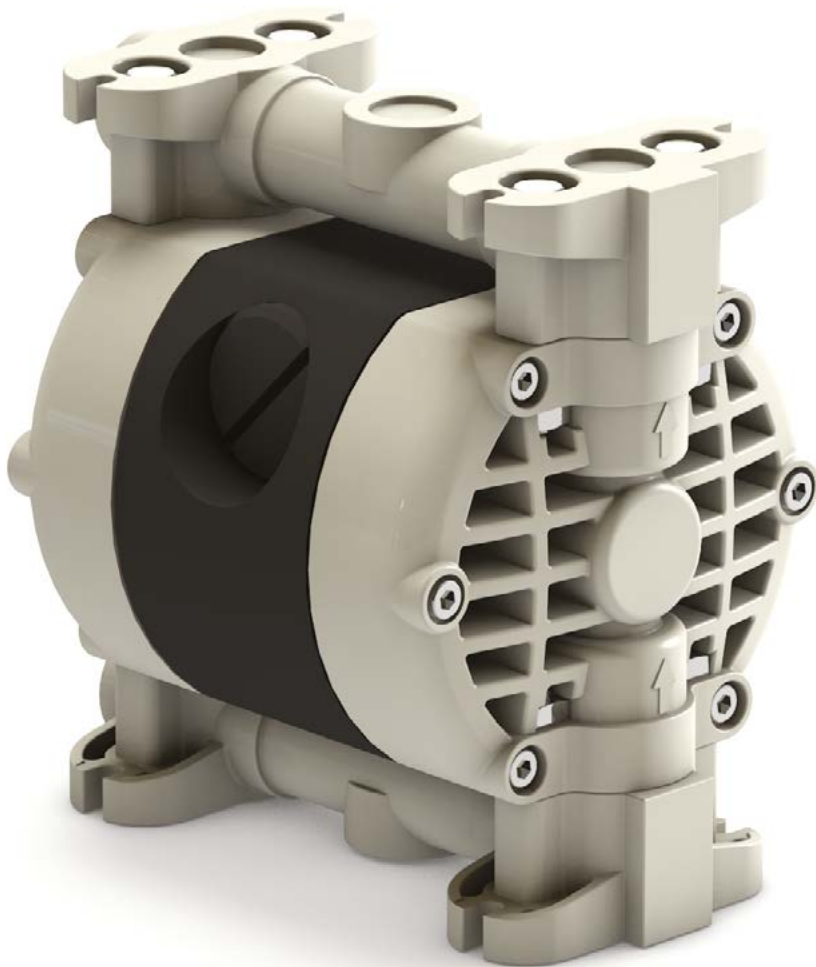

 **STANDARD:** II 3/3 GD c IIB T135°C (zone 2)
CONDUCT: II 2/2 GD c IIB T135°C (zone 1)

Intake/delivery connections G 1/2" f (*) - flow rate 30 l/min

Construction materials PP - PP+CF - PVDF - Alu - AISI 316

(*) NPT connections on request, only with AISI 316 and Alu pumps

DEBEM
MADE IN ITALY

DIAPHRAGM PUMPS MICROBOXER



Ex STANDARD: II 3/3 GD c IIB T135°C (zone 2)
CONDUCT: II 2/2 GD c IIB T135°C (zone 1)

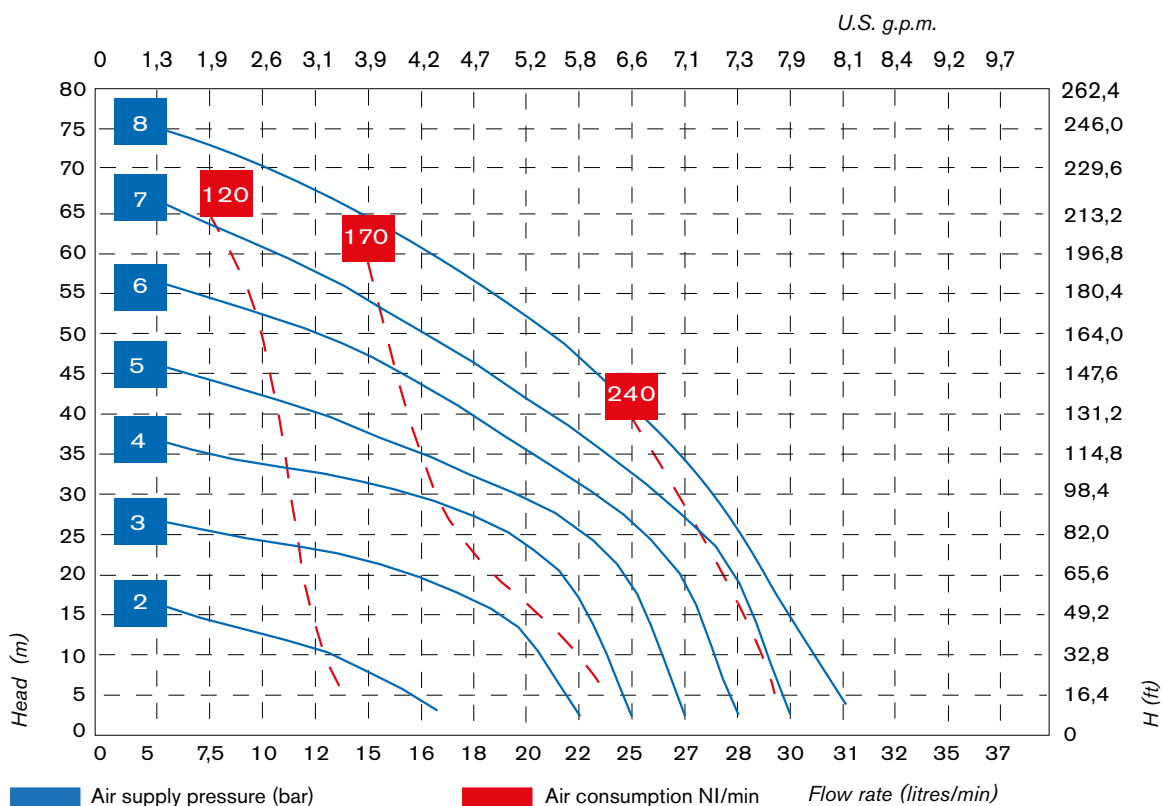

* The curves and performance values refer to pumps with submerged suction and a free delivery outlet with water at 20°C, and vary according to the construction material. ** Attention: the average values of the various configurations of materials by ball and ball seats. *** The value depends on the configuration of the pump.

Guaranteed head/flow rate according to ISO 9906

Intake/delivery connections	G 1/2" f (*)
Air connection	G 1/4" f
Max. flow rate*	30 l/min
Max. air supply pressure	7 bar
Max. head*	80 m
Max. self-priming capacity**	4 m
Max. stored neg. suction	9,5
Max. diameter of passing solids	2 mm
Noise***	65 dB
Displacement per cycle	30 cc
Max. viscosity	20.000 cps

(*) NPT connections on request, only with AISI 316 and Alu pumps

Construction materials and net weight	PP	1,6 Kg	Temp. 3°C min.	65°C max.
	PP+CF	1,6 Kg	Temp. 3°C min.	65°C max.
	PVDF	1,9 Kg	Temp. 3°C min.	95°C max.
	Alu	2 Kg	Temp. 3°C min.	95°C max.
	AISI 316	3,8 Kg	Temp. 3°C min.	95°C max.

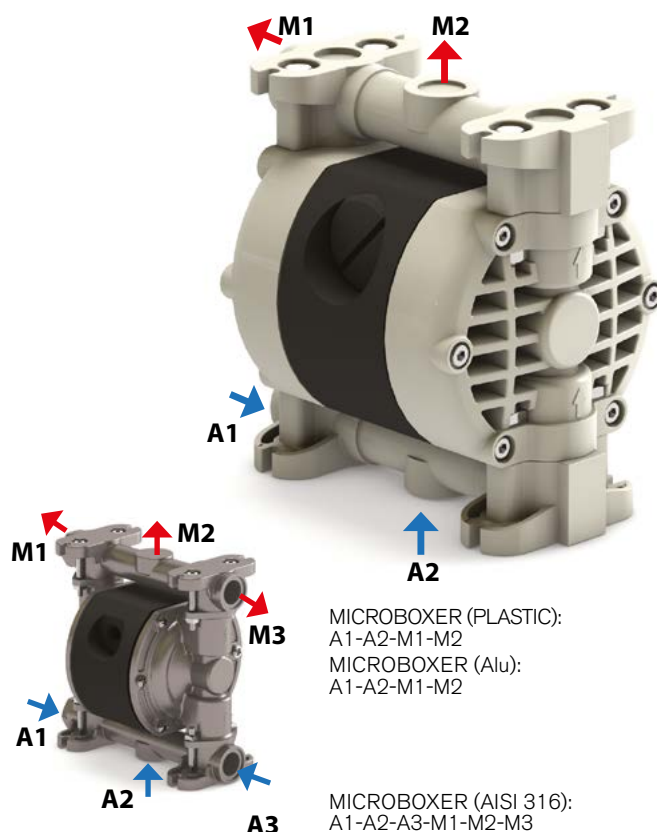

DIAPHRAGM PUMPS

MICROBOXER



Ex STANDARD: II 3/3 GD c IIB T135°C (zone 2)
 CONDUCT: II 2/2 GD c IIB T135°C (zone 1)

AVAILABLE MATERIALS

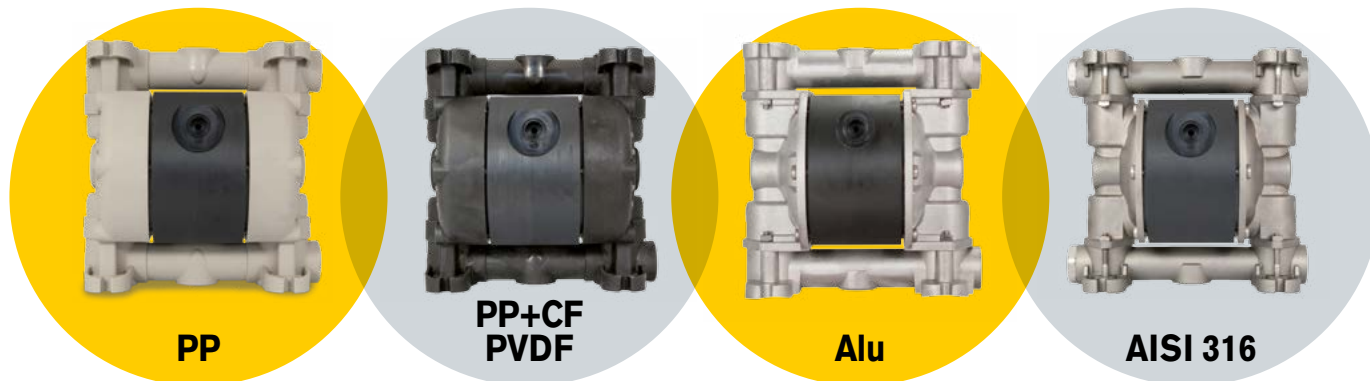

INSTALLATION

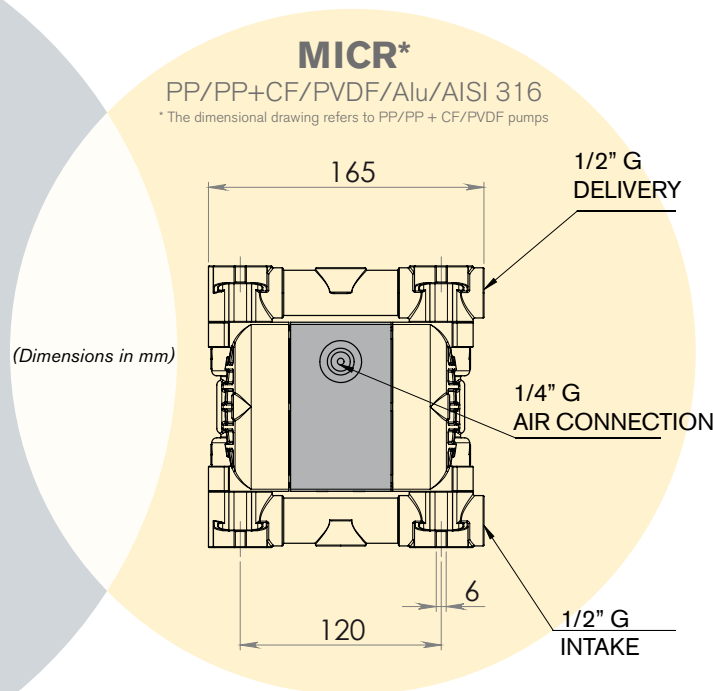
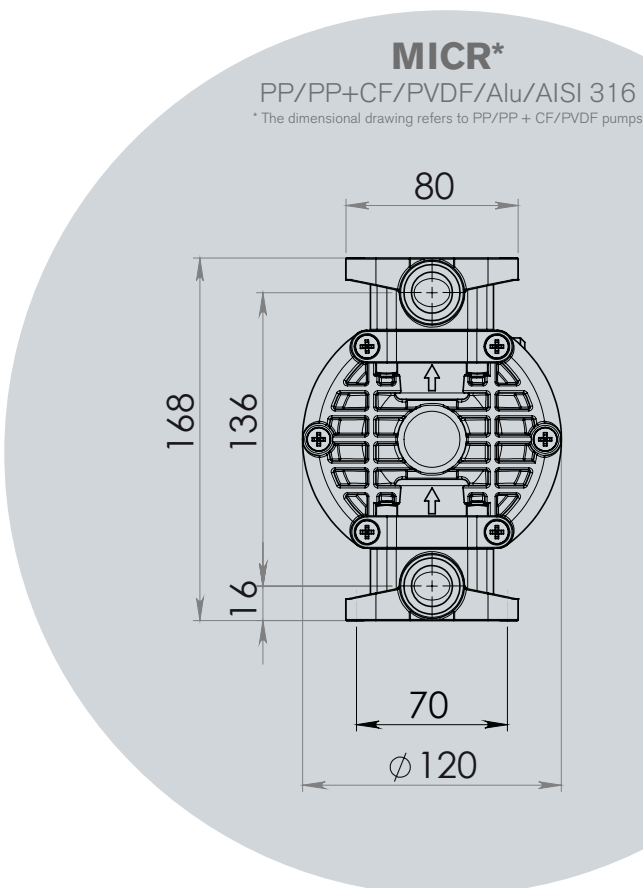
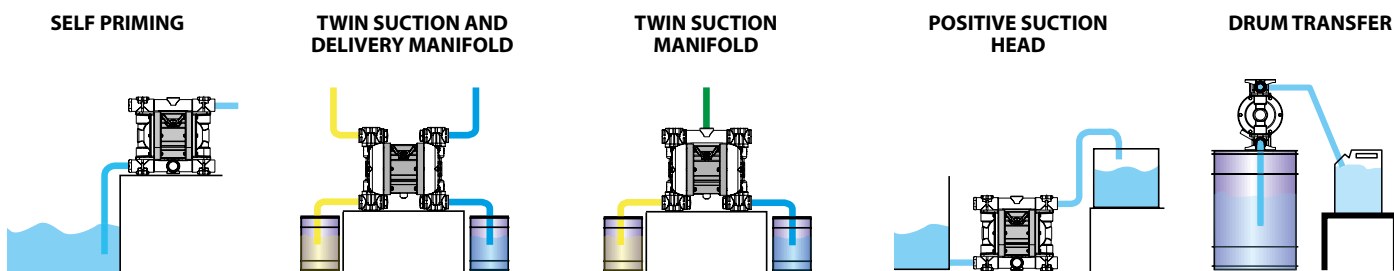

Packaging: cardboard box - 18.5 x 13 x 18 cm - weight: 0.2 Kg
 (the weight only refers to the packaging without the pump in it).

DIAPHRAGM PUMPS

MICROBOXER



Ex STANDARD: II 3/3 GD c IIB T135°C (zone 2)
 CONDUCT: II 2/2 GD c IIB T135°C (zone 1)

BOXER COMPOSITION CODE

ex. **IMICR - P - HT - T - P - V**

Internal Exchanger, Microboxer, body PP, air side diaphragm Hytrel, fluid side diaphragm PTFE, balls PTFE, ball seats PP, O-Ring in Viton.

I	MICR -	P -	H	T	T	P	V	-	-
INTERNAL EXCHANGER	PUMP MODEL	PUMP BODY	AIR SIDE DIAPHRAGM	FLUID SIDE DIAPHRAGM	BALLS	BALL SEATS	O-RING	TWIN MANIFOLD	CONDUCT VERSION
I	MICR - Microboxer	P - PP PC - PP + CF FC - PVDF + CF AL - ALU A - AISI 316	H - Hytrel M - Santoprene D - EPDM N - NBR	T - PTFE*	T - PTFE A - AISI 316 D - EPDM N - NBR	P - Polypropylene F - PVDF A - AISI 316 L - Aluminium I - HMWHDPE	T - PTFE D - EPDM V - Viton N - NBR	X	C

*) Cover diaphragms (only on Hytrel and Santoprene diaphragms) cannot be fitted individually.

PRODUCT APPLICATION

